

## PH 102 Final Exam

**General Rules:** You are allowed 2-8.5x11 in sheets of paper for formulas and a calculator.

August 4, 2009

P. LeClair

### Part I: Multiple choice (50%)

1. Answer 16 of the 20 multiple choice problems.
2. No partial credit will be given for multiple choice questions.

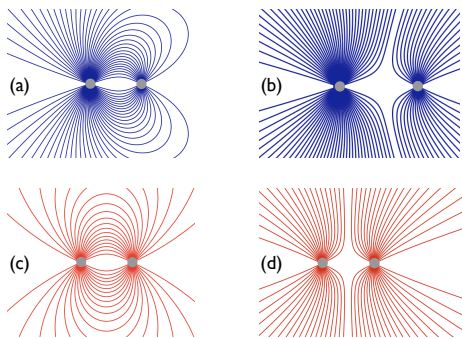

1. Which set of electric field lines could represent the electric field near two charges of *opposite sign* and *different magnitudes*?

- a
- b
- c
- d

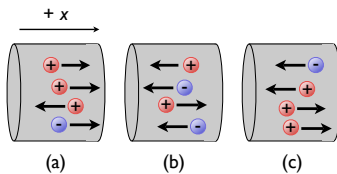

2. Rank the relative currents in figures a, b, and c from lowest to highest. Assume positive current corresponds to positive charges flowing to the right (+x direction), and that all charges move at the same velocity.

- $a < b < c$
- $b < a < c$
- $c = b < a$
- $a < c = b$

3. Three charges are arranged in an equilateral triangle, as shown at left. All three charges have the same *magnitude* of charge,  $|q_1| = |q_2| = |q_3| = 10^{-9} \text{ C}$  (note that  $q_2$  is negative though). What is the **force** on  $q_2$ , magnitude and direction?

- 9.0 nN, up ( $90^\circ$ );
- 16 nN, down ( $-90^\circ$ );
- 18 nN, down and left ( $225^\circ$ );
- 8.0 nN, up and right ( $-45^\circ$ )

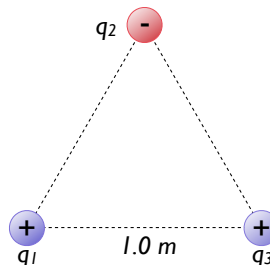

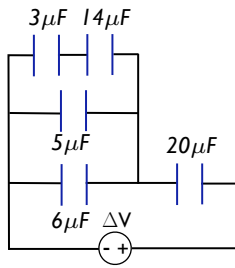

4. What is the equivalent capacitance of this set of capacitors?

- 16.0  $\mu\text{F}$
- 12.0  $\mu\text{F}$
- 8.0  $\mu\text{F}$
- 6.5  $\mu\text{F}$

5. Rank the currents at points 1, 2, 3, 4, 5, and 6 from highest to lowest. The two resistors are identical.

- 5, 1, 3, 2, 4, 6
- 5, 3, 1, 4, 2, 6
- 5=6, 3=4, 1=2
- 5=6, 1=2=3=4
- 1=2=3=4=5=6

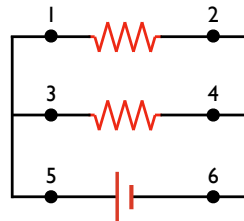

6. As the temperature of a conductor is increased, the number of carriers increases by 100 times, while their drift velocity decreases by 4 times. How much as the resistance changed?

- It decreases by 25 times
- It increases by 25 times
- It increases by 400 times
- It decreases by 400 times

7. A current  $I$  flows through two resistors in series of values  $R$  and  $2R$ . The wire connecting the two resistors is connected to ground at point b. Assume that these resistors are part of a larger complete circuit, such that the current  $I$  is constant in magnitude and direction. What is the electric potential relative to ground at points a and c,  $V_a$  and  $V_c$ , respectively? *Hint: what is the potential of a ground point?*

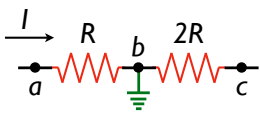

- $V_a = -IR, V_c = -2IR$
- $V_a = 0, V_c = -3IR$
- $V_a = +IR, V_c = +2IR$
- $V_a = +IR, V_c = -2IR$

8. A red laser delivers  $4.15 \times 10^{18}$  photons/sec in a beam diameter of 1.00 mm. Each photon has a wavelength of 680 nm. What is the amplitude of the electric field? Note  $1 \text{ N/C} = 1 \text{ V/m}$ .

- 34000 V/m
- 25000 V/m
- 8000 V/m
- 76000 V/m

9. Refer to the figure at right. Which circuit properly measures the current and voltage for the resistor? You may assume that the voltmeters and ammeters are perfect, and the battery is ideal.

- circuit (a)
- circuit (b)
- circuit (c)
- circuit (d)

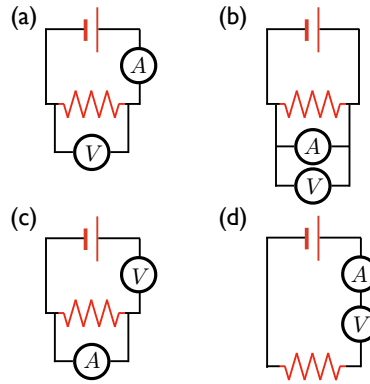

10. What is the equivalent resistance of the four resistors at left?

- $73\ \Omega$
- $18\ \Omega$
- $42\ \Omega$
- $35\ \Omega$

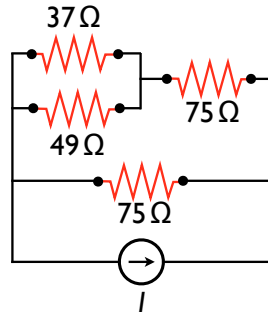

11. As light travels from a vacuum ( $n=1$ ) to a medium such as glass ( $n>1$ ), which of the following properties remains the same?

- wave speed
- frequency
- wavelength

12. A concave makeup mirror is designed so that a person 26 cm in front of it sees an upright image magnified by a factor of two. What is the radius of curvature of the mirror?

- 1.04 m
- 3.78 m
- 0.52 m
- 2.08 m

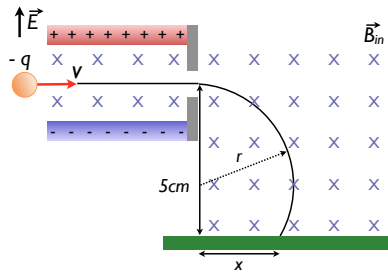

13. Consider the mass spectrometer shown at left. The electric field between the plates of the velocity selector is  $|\vec{E}| = 1000 \text{ V/m}$ . What must the magnitude of the magnetic field be, if  $r = 4.6 \text{ cm}$  for a singly-charged ion with  $m = 7.3 \times 10^{-26} \text{ kg}$ ?

- 1.0 mTesla
- 0.1 Tesla
- 1.0  $\mu$ Tesla
- 0.1 kTesla

14. A conducting rod of length  $l$  moves on two (frictionless) horizontal rails, as shown to the right. A constant force  $\vec{F}_{\text{app}}$  moves the bar at a uniform speed through a magnetic field  $\vec{B}$  directed into the page. What are the directions of the induced current and magnetic force on the bar, respectively?

- counterclockwise; to the left
- clockwise; to the left
- clockwise; to the right
- counterclockwise; to the right

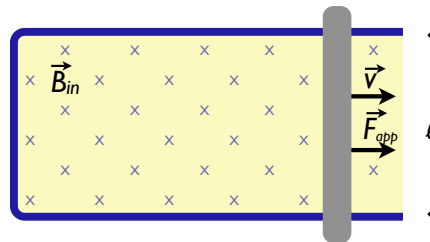

15. A flat metal plate swings at the end of a bar as a pendulum, as shown. When the pendulum is at position **a**, what are the directions of the induced currents and (magnetic) force on the bar, respectively?

- Counterclockwise; to the left
- Clockwise; to the left
- Counterclockwise; to the right
- Clockwise; to the right

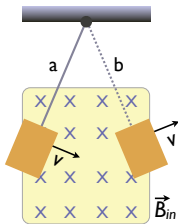

16. An object is placed to the left of a converging lens. Which of the following statements are true and which are false?

1. The image is always to the right of the lens **FALSE**
2. The image can be upright or inverted **TRUE**
3. The image is always smaller or the same size as the object **FALSE**

- 1 and 2 are true, 3 is true
- 2 and 3 are false, 1 is true
- 1 and 3 are false, 2 is true
- 2 and 3 are true, 1 is false

17. A hydrogen atom initially in its ground state ( $n=1$ ) absorbs a photon and ends up in the state for which  $n=3$ . If the atom eventually returns to the ground state, what photon energies could the atom emit?

- 13.6 eV, 1.89 eV, 10.2 eV
- 12.09 eV, 1.89 eV
- 12.09 eV, 1.89 eV, 10.2 eV
- 12.09 eV

18. Photon A is emitted when an electron in a hydrogen atom drops from the  $n=3$  level to the  $n=2$  level. Photon B is emitted when an electron in a hydrogen atom drops from the  $n=4$  level to the  $n=2$  level. Which of the following is true?

- Photon A has the greater wavelength, photon B has the greater energy
- Photon B has the greater wavelength, photon A has the greater energy
- Photon A has the greater wavelength and energy
- Photon B has the greater wavelength and energy

19. A photon of energy  $E_0$  strikes a free electron with the scattered photon of energy  $E$  moving in the direction opposite that of the incident photon. In this Compton effect interaction, what is the resulting kinetic energy of the electron?

- $E$
- $E_0 + E$
- none of these
- $E_0 - E$
- $E_0$

20. Which of the following are possible reactions?

- ${}_0^1\text{n} + {}_{92}^{235}\text{U} \rightarrow {}_{54}^{140}\text{Xe} + {}_{38}^{94}\text{Sr} + 2{}_0^1\text{n}$
- ${}_0^1\text{n} + {}_{92}^{235}\text{U} \rightarrow {}_{50}^{135}\text{Sn} + {}_{42}^{101}\text{Mo} + 3{}_0^1\text{n}$
- ${}_0^1\text{n} + {}_{94}^{235}\text{U} \rightarrow {}_{53}^{127}\text{Sn} + {}_{41}^{93}\text{Mo} + 3{}_0^1\text{n}$
- ${}_2^4\text{He} + {}_{92}^{235}\text{U} \rightarrow {}_{54}^{140}\text{Xe} + {}_{38}^{94}\text{Sr} + 2{}_0^1\text{n}$

**Part II: Problems (50%)**

1. Solve 8 problems out of the 14 below. All problems have equal weight.
2. Clearly mark the problems you choose by filling in the adjacent circle.
3. Show as much work as possible for partial credit.
4. Solve the problems on separate sheets. Staple your sheets to the exam when finished.

□ 1. Initially, the radioactive decay rate of a particular group of nuclei is 300 counts per second. After 5 minutes, the decay rate drops to about 38 counts per second.

(a) What approximately is the half life of this nucleus?

(b) What will be the approximate decay rate (in counts per second) after 2.5 *additional* minutes?

1.67 minutes; 13 counts per second

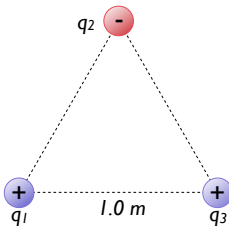

□ 2. Three charges are arranged in an equilateral triangle, as shown at left. All three charges have the same *magnitude* of charge,  $|q_1| = |q_2| = |q_3| = 10^{-9}$  C (note that  $q_2$  is negative though). What is the total **potential energy** of this system of charges? Take the zero of potential energy to be when all charges are infinitely far apart.

About -9nJ.

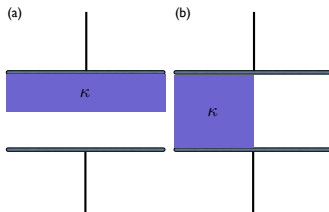

□ 3. A parallel plate capacitor has a capacitance  $C$  when there is vacuum between the plates. The gap between the plates is half filled with a dielectric with dielectric constant  $\kappa$  in two different ways, as shown below. Calculate the effective capacitance, in terms of  $C$  and  $\kappa$ , for both situations. *Hint: try breaking each situation up into two equivalent capacitors.*

Parallel:  $2K/(1+K)$ . Perpendicular:  $(K+1)/2$ .

□ 4. A high-voltage transmission line with a diameter of 1.60 cm and a length 200 km carries a steady current of 1000 A. If the conductor is copper wire with a free charge density of  $n = 8.20 \times 10^{28}$  electrons/m<sup>3</sup>, how long does it take one electron to travel the full length of the line?

16.7 years

□ 5. You need a 45  $\Omega$  resistor, but the stockroom has only 20  $\Omega$  and 50  $\Omega$  resistors. How can the desired resistance be achieved under these circumstances?

Two 50  $\Omega$  resistors in parallel, with a 20  $\Omega$  resistor in series with that combination.

- 6. An alarm clock is set to sound in 15 h. At  $t = 0$  the clock is placed in a spaceship moving with a speed of  $0.77c$  (relative to Earth). What distance, as determined by an Earth observer, does the spaceship travel before the alarm clock sounds?

1.96e13 meters.

- 7. In the 1996 movie *Eraser*, a corrupt business Cyrez is manufacturing a handheld rail gun which fires aluminum bullets at nearly the speed of light. Let us be optimistic and assume the actual velocity is  $0.75c$ . We will also assume that the bullets are tiny, about the mass of a paper clip, or  $m = 5 \times 10^{-4}$  kg.

(a) What is the relativistic kinetic energy of such a bullet?

(b) What *rest mass* would have to be completely converted to energy to supply this kinetic energy? Note that 1 kg of TNT has an equivalent energy content of about  $4 \times 10^9$  J.

- 8. Using an electromagnetic flowmeter (see figure), a heart surgeon monitors the flow rate of blood through an artery. Electrodes A and B make contact with the outer surface of the blood vessel, which has inside **diameter** 3.2 mm. Permanent magnets outside the blood vessel create a magnetic field perpendicular to the blood flow direction. For a magnetic field strength of  $|\vec{B}| = 0.037$  T, a potential difference of  $\Delta V = 160 \mu\text{V}$  appears between the electrodes.

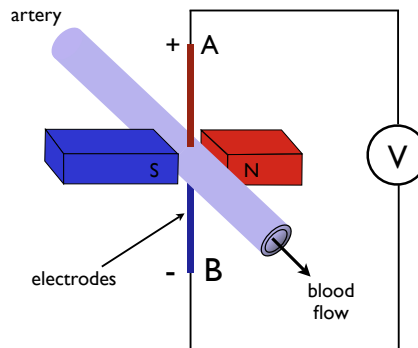

- (a) Calculate the speed of the blood.  
 (b) Does the sign of the potential difference depend on whether the mobile ions in the blood are predominantly positively or negatively charged?

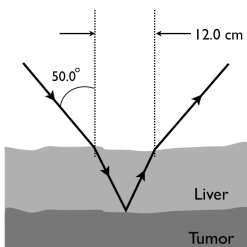

- 9. A narrow beam of ultrasonic waves reflects off the liver tumor in the figure at left. If the speed of the wave is 15.0% less in the liver than in the surrounding medium, determine the depth of the tumor.

- 10. An electron has a velocity of  $3 \times 10^6$  m/s perpendicular to a magnetic field and is observed to move in a circle of radius 0.3 m.

(a) What is the strength of the  $B$  field?

(b) What  $E$  field could you apply (in addition to the  $B$  field) to cause the electron to move in a straight line instead? Give the magnitude and direction (relative to the  $B$  field and the electron's velocity).

- 11. An accelerating charge loses electromagnetic energy at a rate of

$$\mathcal{P} = \frac{\Delta E}{\Delta t} = -\frac{2k_e q^2 a^2}{3c^3}$$

where  $k_e$  is Coulomb's constant,  $q$  is the charge of the particle,  $c$  is the speed of light, and  $a$  is the acceleration of the charge. Assume that an electron is one Bohr radius ( $a_0 = 0.053$  nm) from the center of a Hydrogen atom.

(a) Find the acceleration of the electron (hint: circular path).

(b) Calculate the kinetic energy of the electron and determine within an order of magnitude how long it will take the electron to lose all of its energy, assuming a constant acceleration as found in part (a).

□ **12.** An alpha particle ( $Z = 2$ , mass  $6.64 \times 10^{-27}$  kg) approaches to within  $1.2 \times 10^{-14}$  m of a carbon nucleus ( $Z = 6$ ).

(a) What is the maximum Coulomb force on the alpha particle?

(b) What is the acceleration of the alpha particle at this point?

(c) What is the potential energy (in MeV) of the alpha particle at the same time?

19.2N,  $2.89 \times 10^{27}$  m/s<sup>2</sup>, 1.44MeV

□ **13.** The threshold of dark-adapted (scotopic) vision is  $8.0 \times 10^{-11}$  W/m<sup>2</sup> at a central wavelength of 550 nm. If light with this intensity and wavelength enters the eye when the pupil is open to its maximum diameter of 8.0 mm, how many photons per second enter the eye?

11100 photons/s

□ **14.** The average lifetime of a pi meson in its own frame of reference (*i.e.*, the proper lifetime) is  $2.6 \times 10^{-8}$  s

(a) If the meson moves with a speed of  $0.98c$ , what is its mean lifetime as measured by an observer on earth?

(b) What is the average distance it travels before decaying, as measured by an observer on Earth?

(c) What distance would it travel if time dilation did not occur?

**BONUS** (worth as much as 1 multiple-choice question):

**1.** Using capacitors, resistors, and inductors, sketch a circuit to split an audio signal composed of many frequencies into a low frequency part and a high frequency part, for distribution to speakers. That is, filter the incoming signal into separate low frequencies and high frequencies to send to a woofer and tweeter, respectively. You do not need to specify the values of your components.



**Constants:**

$$k_e = 8.98755 \times 10^9 \text{ N} \cdot \text{m}^2 \cdot \text{C}^{-2}$$

$$\mu_0 \equiv 4\pi \times 10^{-7} \text{ T} \cdot \text{m/A}$$

$$\epsilon_0 = 8.85 \times 10^{12} \text{ C}^2/\text{N} \cdot \text{m}^2$$

$$e = 1.60218 \times 10^{-19} \text{ C}$$

$$h = 6.6261 \times 10^{-34} \text{ J} \cdot \text{s} = 4.1357 \times 10^{-15} \text{ eV} \cdot \text{s} \quad 0 = ax^2 + bx^2 + c \implies x = \frac{-b \pm \sqrt{b^2 - 4ac}}{2a}$$

$$\hbar = \frac{h}{2\pi}$$

$$c = \frac{1}{\sqrt{\mu_0 \epsilon_0}} = 2.99792 \times 10^8 \text{ m/s}$$

$$m_{e^-} = 9.10938 \times 10^{-31} \text{ kg} = 0.510998 \text{ MeV}/c^2$$

$$m_{p^+} = 1.67262 \times 10^{-27} \text{ kg} = 938.272 \text{ MeV}/c^2$$

$$m_{n^0} = 1.67493 \times 10^{-27} \text{ kg} = 939.565 \text{ MeV}/c^2$$

$$1 \text{ u} = 931.494 \text{ MeV}/c^2$$

$$hc = 1239.84 \text{ eV} \cdot \text{nm}$$

$$\frac{h}{m_e c} = 2.42631 \times 10^{-12} \text{ m}$$

**Quadratic formula:**

**Basic Equations:**

$$\vec{\mathbf{F}}_{\text{net}} = m\vec{\mathbf{a}} \text{ Newton's Second Law}$$

$$\vec{\mathbf{F}}_{\text{centr}} = -\frac{mv^2}{r} \hat{\mathbf{r}} \text{ Centripetal}$$

$$\text{KE} = (\gamma - 1)mc^2 \approx \frac{1}{2}mv^2 \text{ Kinetic energy}$$

$$\text{KE}_{\text{initial}} + \text{PE}_{\text{initial}} = \text{KE}_{\text{final}} + \text{PE}_{\text{final}}$$

**Magnetism**

$$|\vec{\mathbf{F}}_B| = q|\vec{\mathbf{v}}||\vec{\mathbf{B}}| \sin \theta_{vB} \text{ charge } q$$

$$|\vec{\mathbf{F}}_B| = BIl \sin \theta \text{ wire}$$

$$|\vec{\tau}| = BIAN \sin \theta \text{ torque current loop}$$

$$\vec{\mathbf{B}} = \frac{\mu_0 I}{2\pi r} \hat{\theta} \text{ wire}$$

$$\vec{\mathbf{B}} = \mu_0 \frac{N}{L} I \hat{\mathbf{z}} \equiv \mu_0 n I \hat{\mathbf{z}} \text{ solenoid}$$

$$\frac{|\vec{\mathbf{F}}_{12}|}{l} = \frac{\mu_0 I_1 I_2}{2\pi d} \text{ 2 wires, force per length}$$

**Electric Potential:**

$$\Delta V = V_B - V_A = \frac{\Delta \text{PE}}{q}$$

$$q\Delta V = \Delta \text{PE}$$

$$\Delta PE = q\Delta V = -q|\vec{\mathbf{E}}||\Delta \vec{\mathbf{x}}| \cos \theta = -qE_x \Delta x$$

↑ constant E field

$$V_{\text{point charge}} = k_e \frac{q}{r}$$

$$PE_{\text{pair of point charges}} = k_e \frac{q_1 q_2}{r_{12}}$$

$$PE_{\text{system}} = \text{sum over unique pairs of charges}$$

$$-W = \Delta \text{PE} = q(V_B - V_A)$$

**Current:**

$$I = \frac{\Delta Q}{\Delta t} = nqAv_d$$

$$J = \frac{I}{A} = nqv_d$$

$$v_d = \frac{-e\tau}{m} E \quad \tau = \text{scattering time}$$

$$\rho = \frac{m}{ne^2\tau}$$

$$\Delta V = \frac{\rho l}{A} I = RI$$

$$R = \frac{\rho l}{A} = \frac{\Delta V}{I}$$

$$\mathcal{P} = I\Delta V = I^2 R = IV \text{ power}$$

**Optics:**

$$\mathcal{E} = hf = \frac{hc}{\lambda} = \frac{1239.84 \text{ eV} \cdot \text{nm}}{\lambda (\text{nm})}$$

$$n = \frac{\text{speed of light in vacuum}}{\text{speed of light in a medium}} = \frac{c}{v}$$

$$\frac{\lambda_1}{\lambda_2} = \frac{v_1}{v_2} = \frac{c/n_1}{c/n_2} = \frac{n_2}{n_1} \text{ refraction}$$

$$\lambda_1 n_1 = \lambda_2 n_2 \text{ refraction}$$

$$n_1 \sin \theta_1 = n_2 \sin \theta_2 \text{ Snell's refraction}$$

$$n_1 \sin \theta_c = n_2 \sin 90^\circ = n_2 \text{ total internal refl.}$$

$$\lambda f = c$$

$$M = \frac{h'}{h} = -\frac{q}{p}$$

$$\frac{1}{f} = \frac{1}{p} + \frac{1}{q} = \frac{2}{R}$$

**EM Waves:**

$$c = \lambda f = \frac{|\vec{\mathbf{E}}|}{|\vec{\mathbf{B}}|}$$

$$\mathcal{I} = \left[ \frac{\text{photons}}{\text{time}} \right] \left[ \frac{\text{energy}}{\text{photon}} \right] \left[ \frac{1}{\text{Area}} \right]$$

$$\mathcal{I} = \frac{\text{energy}}{\text{time} \cdot \text{area}} = \frac{E_{\text{max}} B_{\text{max}}}{2\mu_0} = \frac{\text{power } (\mathcal{P})}{\text{area}} = \frac{E_{\text{max}}^2}{2\mu_0 c}$$

**Electric Force & Field**

$$\begin{aligned}\vec{\mathbf{F}}_e &= q\vec{\mathbf{E}} \\ \vec{\mathbf{E}} &= k_e \frac{|q|}{r^2} \\ \Phi_E &= |\vec{\mathbf{E}}|A \cos \theta_{EA} \\ \Phi_E &= \frac{Q_{\text{inside}}}{\epsilon_0} \\ \Delta PE &= -W = -q|\vec{\mathbf{E}}||\Delta\vec{\mathbf{x}}| \cos \theta = -qE_x \Delta x \\ &\uparrow \text{ constant E field}\end{aligned}$$

**Capacitors:**

$$\begin{aligned}Q_{\text{capacitor}} &= C\Delta V \\ C_{\text{parallel plate}} &= \frac{\epsilon_0 A}{d} \\ E_{\text{capacitor}} &= \frac{1}{2}Q\Delta V \\ C_{\text{eq, par}} &= C_1 + C_2 \\ C_{\text{eq, series}} &= \frac{C_1 C_2}{C_1 + C_2} \\ C_{\text{with dielectric}} &= \kappa C_{\text{without}}\end{aligned}$$

**Resistors:**

$$\begin{aligned}I_{V \text{ source}} &= \frac{\Delta V}{R+r} \\ \Delta V_{V \text{ source}} &= \Delta V_{\text{rated}} \frac{R}{r+R} \\ I_{I \text{ source}} &= I_{\text{rated}} \frac{r}{r+R} \\ R_{\text{eq, series}} &= R_1 + R_2 \\ R_{\text{eq, par}} &= \frac{R_1 R_2}{R_1 + R_2}\end{aligned}$$

**Vectors:**

$$\begin{aligned}|\vec{\mathbf{F}}| &= \sqrt{F_x^2 + F_y^2} \text{ magnitude} \\ \theta &= \tan^{-1} \left[ \frac{F_y}{F_x} \right] \text{ direction}\end{aligned}$$

**Relativity**

$$\begin{aligned}\gamma &= \frac{1}{\sqrt{1 - \frac{v^2}{c^2}}} \\ \Delta t &= \gamma \Delta t_p \\ L &= L_p / \gamma \\ p &= \gamma m v \\ v_1 &= \frac{v_2 + v_1'}{1 + v_1' v_2 / c^2} \\ \text{KE} &= (\gamma - 1) m c^2 \\ E_{\text{tot}} &= \gamma m c^2 = \text{KE} + m c^2 \\ E_{\text{rest}} &= m c^2 \\ E^2 &= p^2 c^2 + m^2 c^4\end{aligned}$$

**Units**

$$\begin{aligned}1 \text{ T} \cdot \text{m/A} &= 1 \text{ N/A}^2 \\ 1 \text{ T} \cdot \text{m}^2 &= 1 \text{ V} \cdot \text{s} \\ 1 \text{ T} &= 1 \text{ kg/A} \cdot \text{s}^2 \\ 1 \text{ eV} &= 1.6 \times 10^{-19} \text{ J} \\ 1 \text{ J} &= 1 \text{ N} \cdot \text{m} = 1 \text{ kg} \cdot \text{m}^2 / \text{s}^2 \\ 1 \text{ N} &= 1 \text{ kg} \cdot \text{m/s}^2 \\ 1 \text{ W} &= 1 \text{ J/s} = 1 \text{ kg} \cdot \text{m}^2 / \text{s}^3 \\ 1 \text{ F} &= 1 \text{ C/V} \quad 1 \text{ C} = 1 \text{ A/s} \\ 1 \text{ N/C} &= 1 \text{ V/m}\end{aligned}$$

**Induction:**

$$\begin{aligned}\Phi_B &= B_{\perp} A = B A \cos \theta_{BA} \\ \Delta V &= -N \frac{\Delta \Phi_B}{\Delta t} \\ L &= N \frac{\Delta \Phi_B}{\Delta I} = \frac{N \Phi_B}{I} \\ \Delta V &= |\vec{v}| |\vec{B}| l = |\vec{E}| l \text{ motional voltage}\end{aligned}$$

**ac Circuits**

$$\begin{aligned}\tau &= L/R \text{ RL circuit} \\ \tau &= RC \text{ RC circuit} \\ X_C &= \frac{1}{2\pi f C} \text{ "resistance" of a capacitor for ac} \\ X_L &= 2\pi f L \text{ "resistance" of an inductor for a}\end{aligned}$$

**Nuclear**

$$\begin{aligned}E^2 &= p^2 c^2 + m^2 c^4 \\ \text{alpha particle} &= {}^4_2\alpha = {}^4_2\text{He} \quad \text{beta particle} = {}^0_{-1}\beta = e^- \\ \text{Binding Energy} &= \left[ \sum_{p^+ \& n^0} m c^2 \right] - m_{\text{atom}} c^2\end{aligned}$$

**Quantum & Atomic**

$$\begin{aligned}\lambda_{\text{out}} - \lambda_{\text{in}} &= \frac{h}{m_e c} (1 - \cos \theta) \\ \lambda &= \frac{h}{|\vec{p}|} = \frac{h}{\gamma m v} \approx \frac{h}{m v} \\ \Delta x \Delta p &\geq \frac{h}{4\pi} \\ \Delta E \Delta t &\geq \frac{h}{4\pi} \\ E_n &= -13.6 \text{ eV} / n^2 \\ E_i - E_f &= -13.6 \text{ eV} \left( \frac{1}{n_f^2} - \frac{1}{n_i^2} \right) = h f \text{ Hydrogen only} \\ m v r &= n \hbar \\ v^2 &= \frac{n^2 \hbar^2}{m_e^2 r^2} = \frac{k_e e^2}{m_e r}\end{aligned}$$