

PRINCIPLES & PRACTICE OF
PHYSICS

Chapter 11
Motion in a
Circle

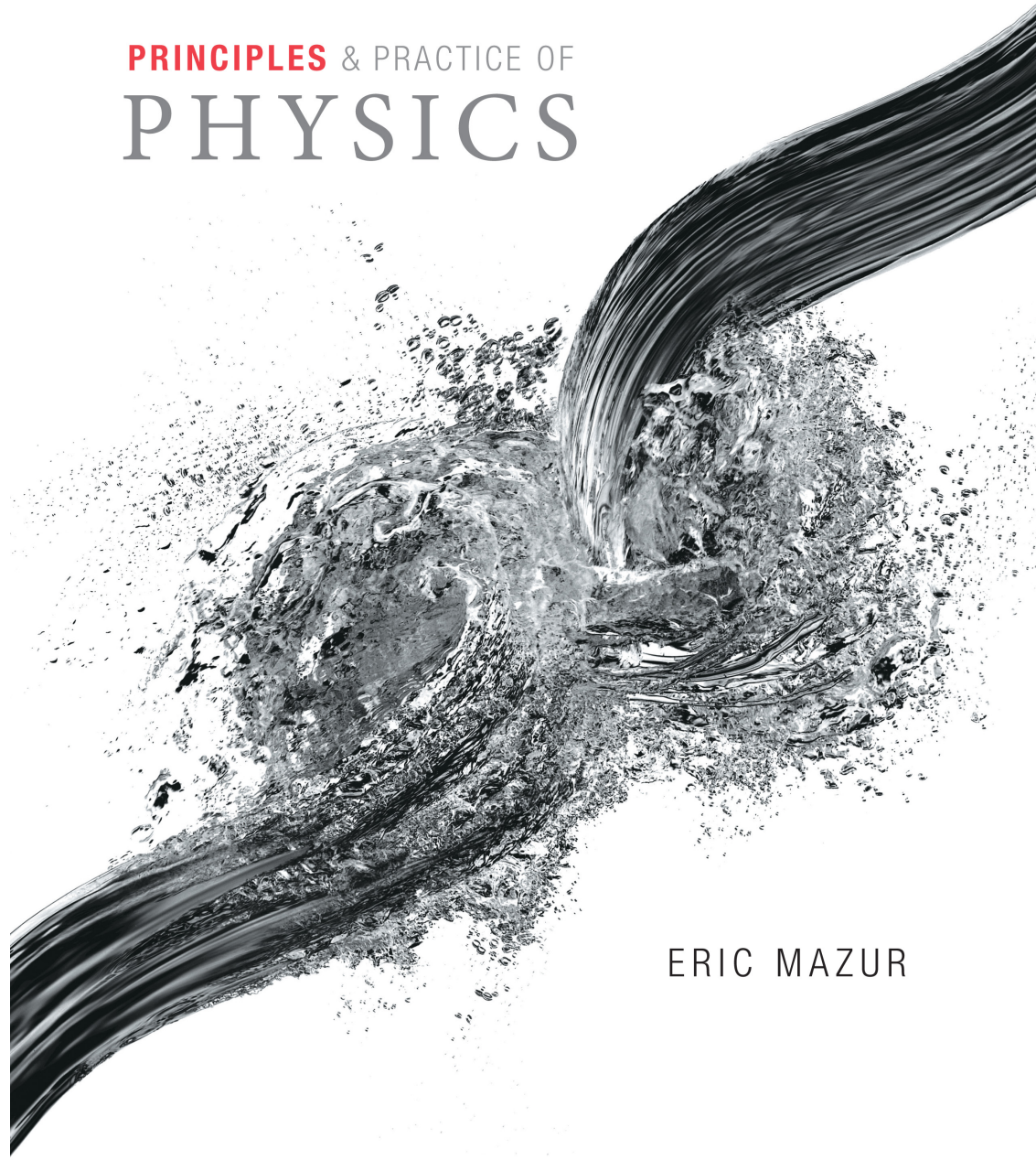

ERIC MAZUR

“Lab” today

- No experiment, problem solving day
- Might be useful to bring your textbook
- Work in groups

Chapter 11: Motion in a Circle

- The motion we have been dealing with so far is called **translational motion** (figure part *a*).
- In this chapter we will start exploring **rotational motion**.
- In rotational motion (figure parts *b* and *c*), the orientation of the object changes, and the particles in the object follow different circular paths centered on the axis of rotation.

(a) Translational motion

All points on object follow identical trajectories.

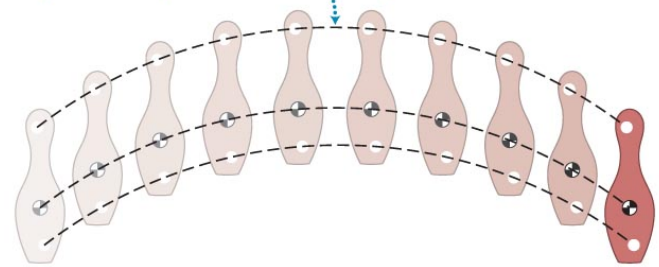

(b) Rotational motion

All points on object trace circles centered on axis of rotation.

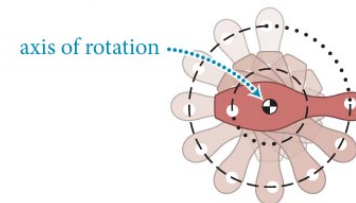

(c) Combined translation and rotation

Different points on object follow different trajectories.

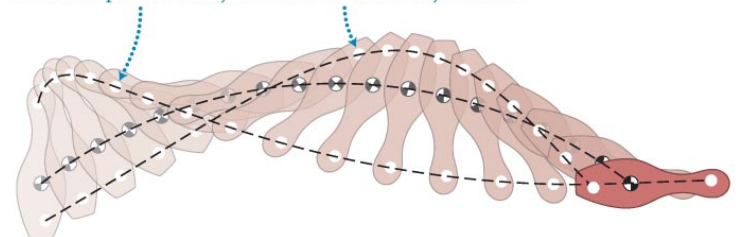

Section 11.1: Circular motion at constant speed

- Goal: kinematics of circular motion
- The figure shows two examples of circular motion.
- The block and the puck revolve around the vertical axis through the center of each circular path.

(a) Block revolves on rotating turntable

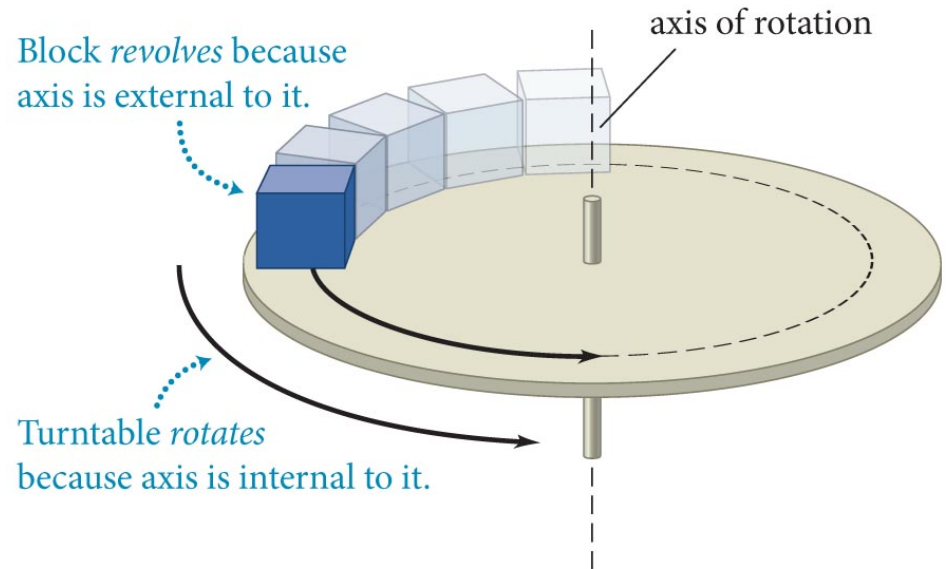

(b) Tethered puck revolves on air table

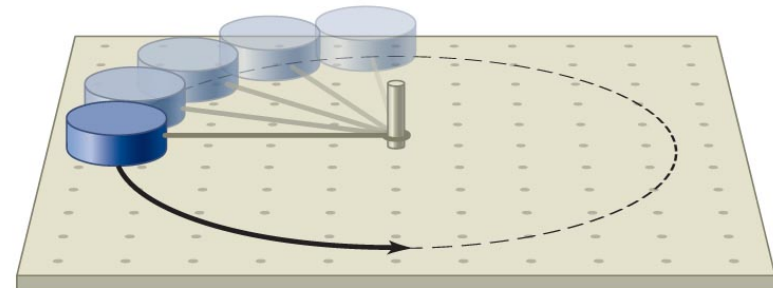

Section 11.1: Circular motion at constant speed

- The figure shows an overhead view of the puck moving along the arc of a circle.
- The instantaneous velocity \vec{v} of an object in circular motion is always perpendicular to the object's position \vec{r} measured from the center of the circular trajectory.
- In the first part of this chapter, we study only objects in **circular motion at constant speed**.

Average velocity points in same direction as displacement $\Delta\vec{r}$.

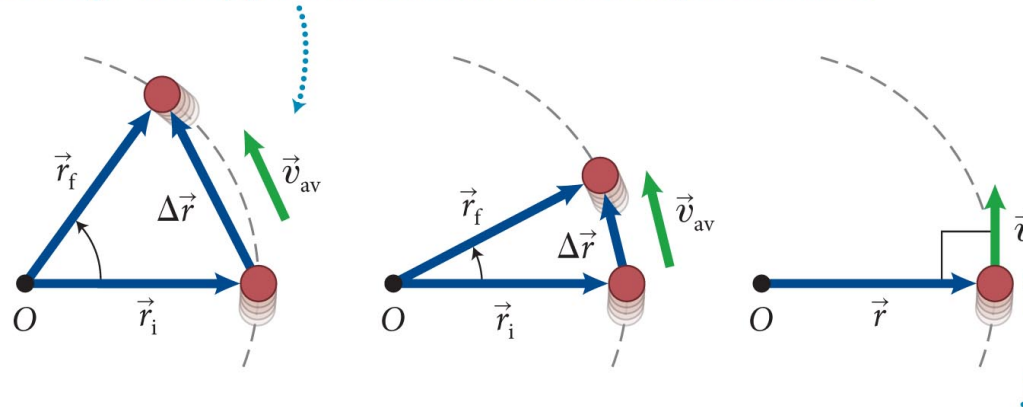

As time interval approaches zero, average velocity approaches instantaneous velocity, which is tangent to circular trajectory.

Section 11.1: Circular motion at constant speed

- The position of an object in circular motion can be given in polar coordinates (r, θ) .
- The magnitude of the position vector of an object in circular motion is the radius.
- To specify the direction of motion, we define the object's **rotational coordinate** (ϑ), as illustrated in part *a* of the figure.
- As shown in part *b*, the direction of increase of ϑ is denoted by a curved arrow around the axis of rotation.

(a) Relationship between rotational coordinate and polar angle

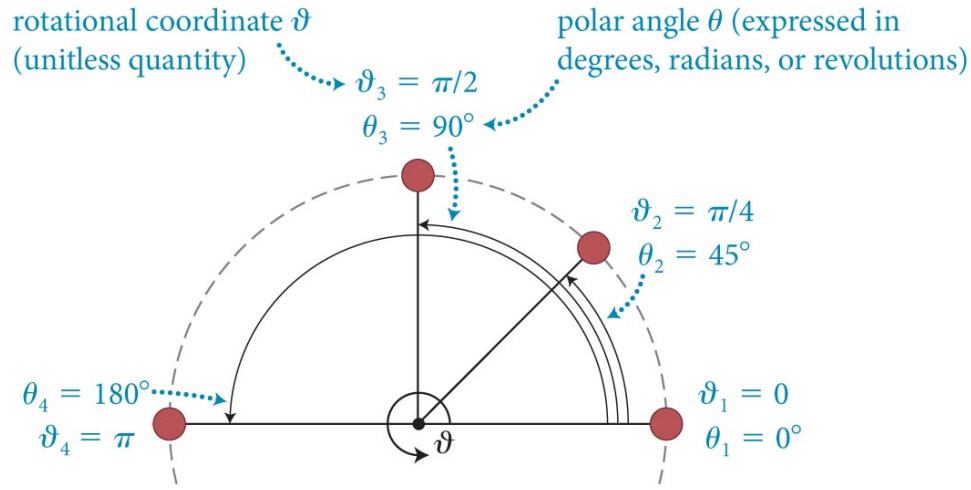

(b) Symbol used in this text to specify rotational coordinate system

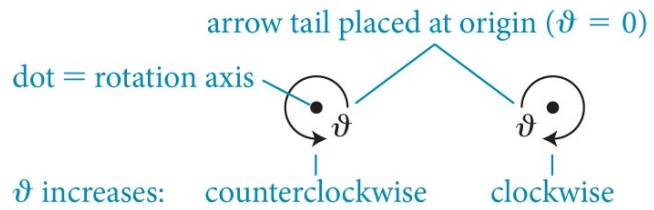

Section 11.1: Circular motion at constant speed

- The rate at which an object's rotational coordinate (ϑ) changes is the **rotational velocity**: $\omega_{\vartheta} = d\vartheta/dt$.
- ω_{ϑ} is the ϑ component of the rotational velocity vector $\vec{\omega}$.
- Units of rotational velocity and rotational speed are s^{-1} .
 - an analogous unit: rpm
- The magnitude of rotational velocity is the **rotational speed**, which is denoted by ω : $\omega = |\vec{\omega}| = |\omega_{\vartheta}|$.
- The time it takes for one revolution is called the **period** (T). $T = C/v = 2\pi r/v = 2\pi/\omega$

Section 11.1: Circular motion at constant speed

- The relationship between an object's speed and angular velocity is illustrated in the figure below.

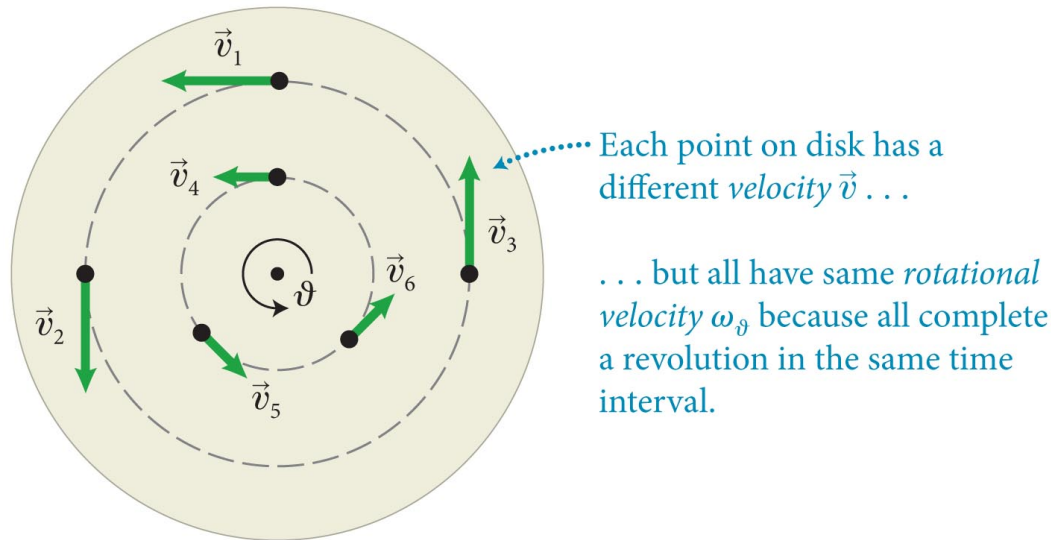

- All points on the disc have the same rotational velocity.
- However, the speed depends on the radius of the circle: The further the point is from the rotation axis, the larger the speed.
- What should the direction of ω be if it is a vector?

Section 11.1: Circular motion at constant speed

- As shown in the figure, even though the initial and final speeds of the object in circular motion are the same, the object undergoes a change in velocity $\Delta\vec{v}$.
- **This means the object is accelerating, even if the *speed* is constant.**
- Using the vector subtraction method, we can determine that $\Delta\vec{v} = \vec{v}_f - \vec{v}_i$ points toward the center of the circle.

(a)

Puck accelerates because its velocity changes direction.

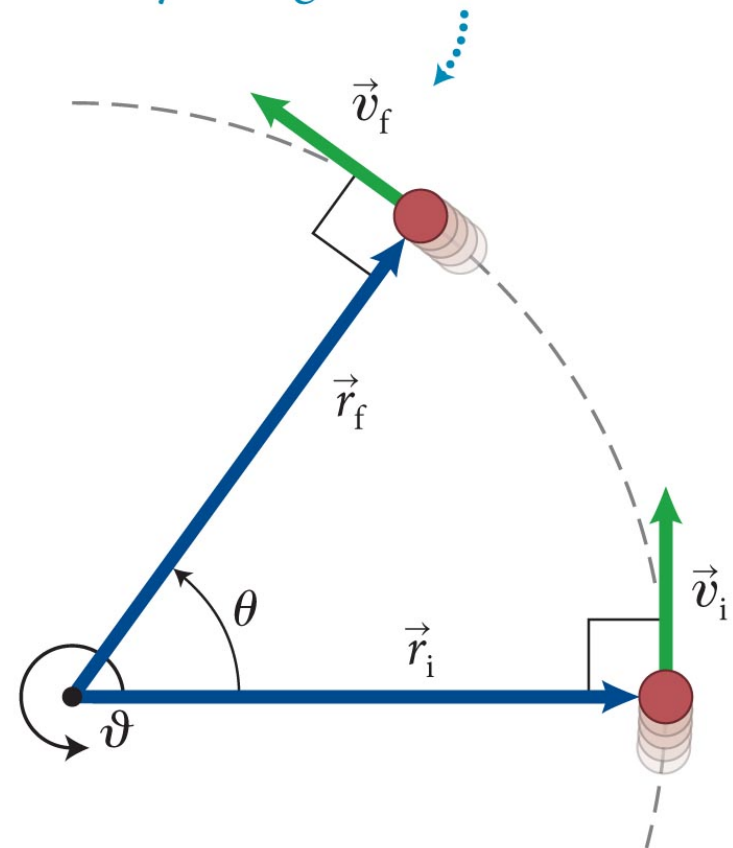

Section 11.1: Circular motion at constant speed

- This means the average accelerating $\vec{a}_{av} \equiv \Delta\vec{v} / \Delta(t)$ also points toward the center.
- **An object executing circular motion at constant speed has an acceleration of constant magnitude that is directed toward the center of its circular path.**
- This acceleration is called the **centripetal acceleration**.

(b)

To find puck's average acceleration:

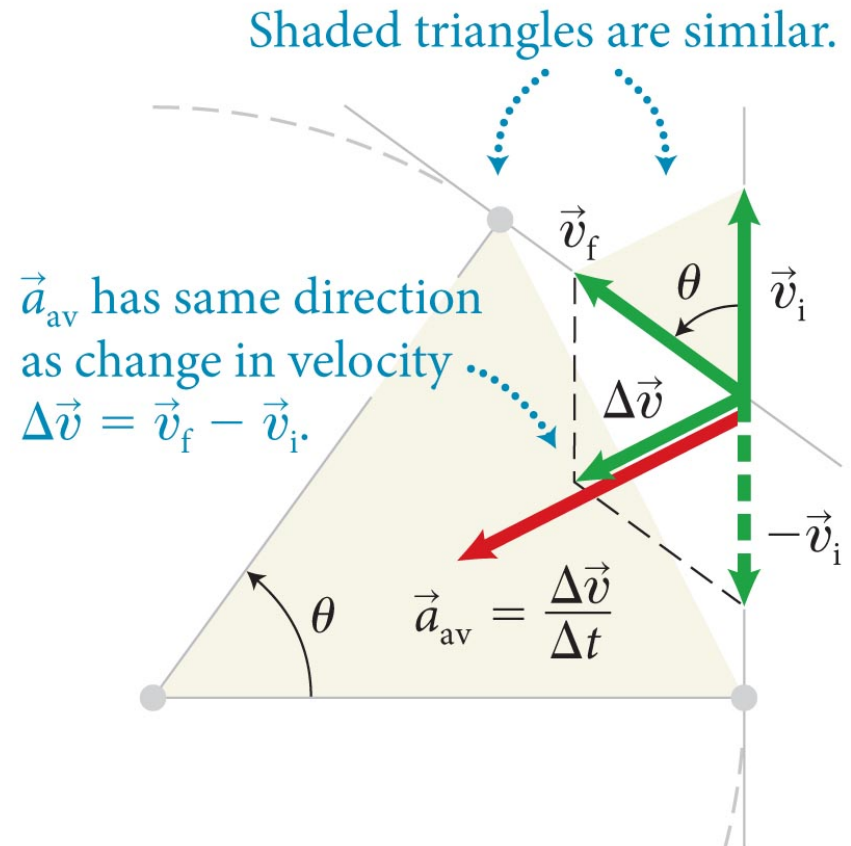

Section 11.1: Circular motion at constant speed

- As illustrated in the figure, we use a rotational coordinate system to analyze circular motion

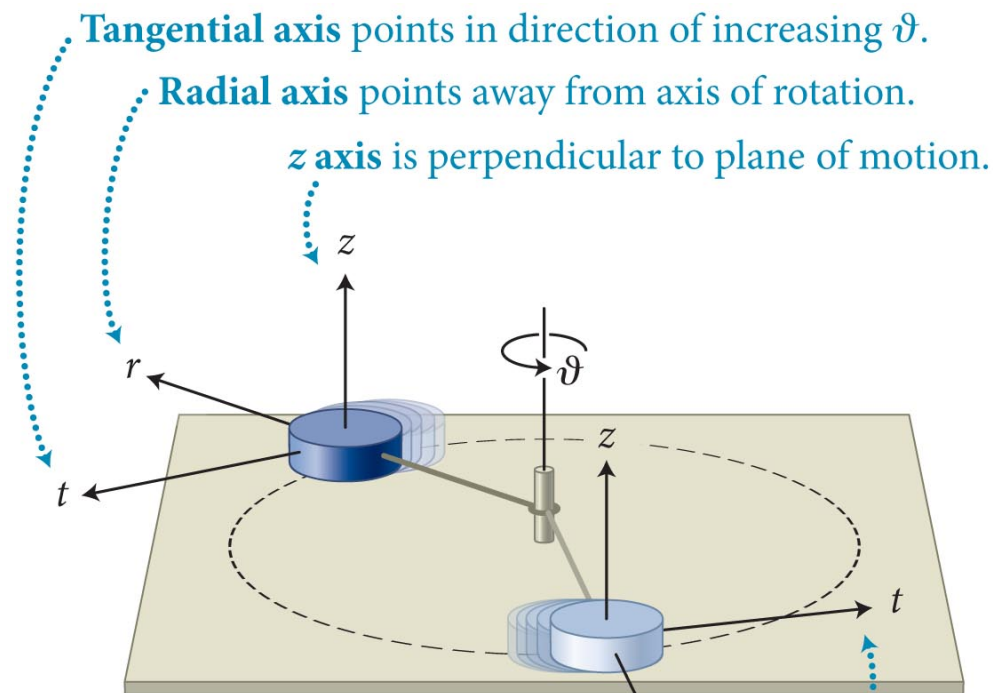

Tangential axis points in direction of increasing ϑ .

Radial axis points away from axis of rotation.

z axis is perpendicular to plane of motion.

(cylindrical coordinates)

r and t axes change direction as they rotate with object.

Checkpoint 11.1



11.1 Suppose an object is in *accelerated* circular motion, so that $|\vec{v}_f| > |\vec{v}_i|$. In which direction does the object's average acceleration point?

if the speed is increasing, there must be a component of acceleration along the path direction too

adding this to the perpendicular acceleration due to circular motion, the net acceleration must now be more toward the direction of motion

Section 11.1

Question 2

For an object in circular motion at constant speed, the directions of the object's **position** vector (relative to the center of the circular trajectory), **velocity** vector, and **acceleration** vector at a given instant are

1. all radially inward.
2. all radially outward.
3. all tangential.
4. radially outward, tangential, and radially inward respectively.
5. none of the above.

Section 11.1

Question 2

For an object in circular motion at constant speed, the directions of the object's position vector (relative to the center of the circular trajectory), velocity vector, and acceleration vector at a given instant are

1. all radially inward.
2. all radially outward.
3. all tangential.
- ✓ 4. radially outward, tangential, and radially inward respectively.
5. none of the above.

Section 11.2: Forces and circular motion

Section Goals

You will learn to

- Analyze the circular motion of particles using Newton's laws.
- Represent the relationship between force and circular motion on force diagrams and motion diagrams.

path of person in absence of forces

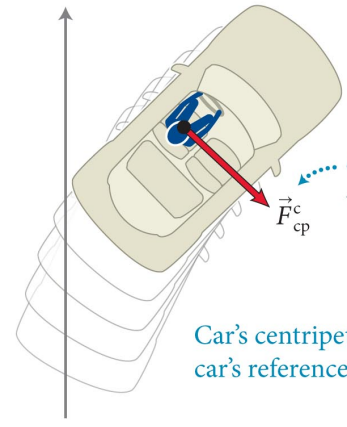

Car exerts force on person that points toward center of circular trajectory.

Car's centripetal acceleration means car's reference frame is not inertial.

Motion

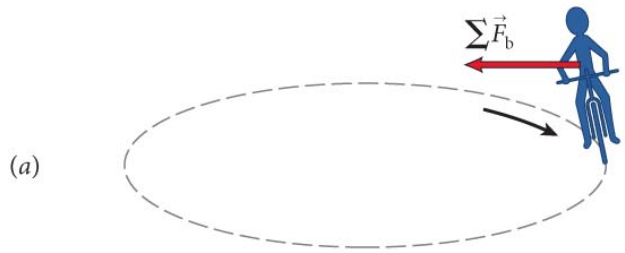

Free-body diagram

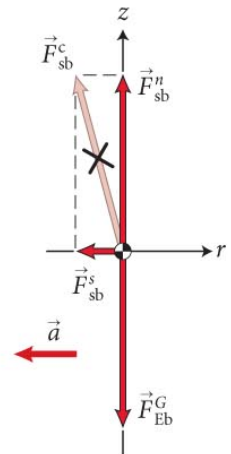

Centripetal acceleration supplied by:

horizontal component of contact force exerted by road surface (static friction)

Section 11.2: Forces and circular motion

- As we saw, the centripetal acceleration of an object in circular motion at constant speed points toward the center of the circle. Then from Newton's second law:
 - **An object that executes circular motion at constant speed is subject to a force (or vector sum of forces) of constant magnitude directed toward the center of the circular trajectory.**

Section 11.2: Forces and circular motion

- Suppose you round a curve in a car as shown below. The car exerts a force on you that points toward the center.
- However, you feel as if you are being pushed outward. Why?
- This feeling of being pushed outward arises only from the noninertial nature of the car's reference frame.
- “Tidal” force because your head & seat accelerate differently
 - **Avoid analyzing forces from a rotating frame of reference because such a frame is accelerating and therefore noninertial.**

Velocity points along your path (tangential), *acceleration* points the direction you are turning

path of person in
absence of forces

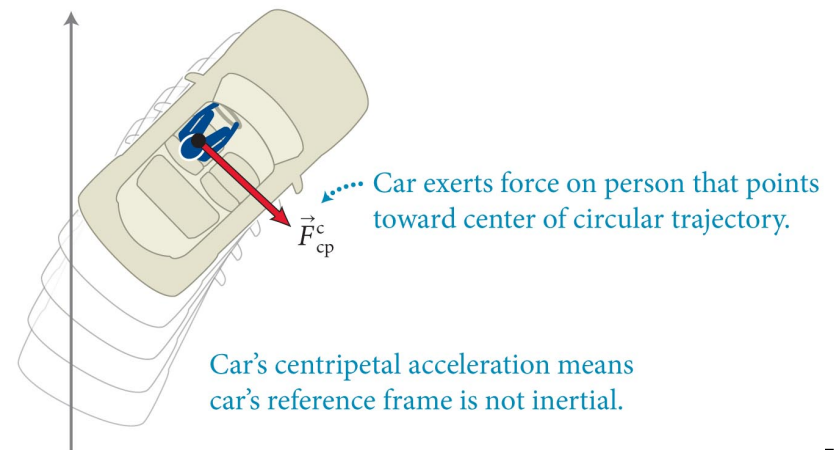

Section 11.2: Forces and circular motion

- To see how the inward force depends on radius, look at the two figures below. (a)

When two pucks move at same speed on circles of different radius . . .

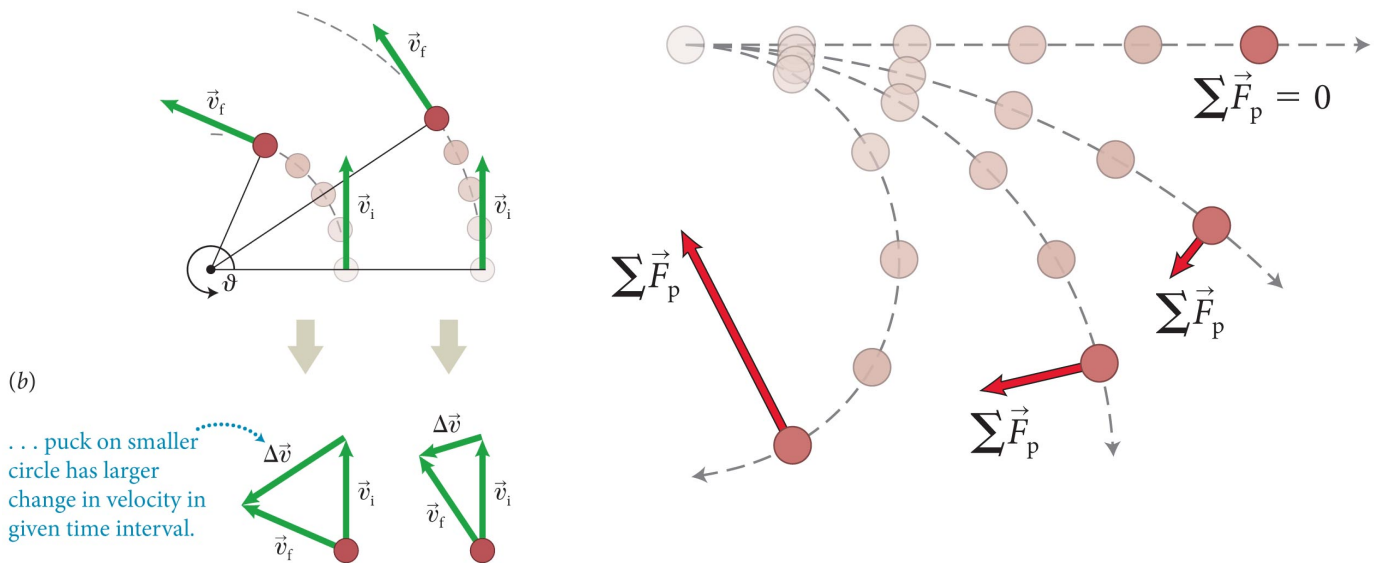

- We can conclude that
 - The inward force required to make an object move in a circular motion increases with increasing speed and decreases with increasing radius.**
 - Tighter turn or faster = more force needed**

Section 11.2: Forces and circular motion

Example 11.3 Cube on a turntable

A cube lies on a turntable initially rotating at constant speed. The rotational speed of the turntable is slowly increased, and at some instant the cube slides off the turntable. Explain why this happens.

Section 11.2: Forces and circular motion

Example 11.3 Cube on a turntable (cont.)

① GETTING STARTED I'm not given much information, so I begin by making a sketch of the situation (Figure 11.15a). As the turntable rotates, the cube executes a circular motion. My task is to explain why the cube does not remain on the turntable as the turntable rotates faster.

(a)

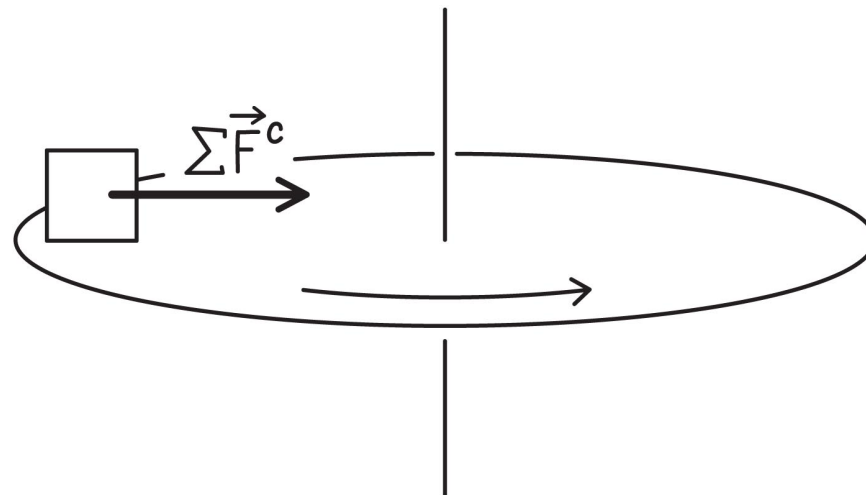

Section 11.2: Forces and circular motion

Example 11.3 Cube on a turntable (cont.)

② **DEVISE PLAN** Because the cube executes circular motion, it has a centripetal acceleration, and so the **vector sum of the forces exerted on it must point toward the center of the turntable.**

I therefore need to make a free-body diagram that reflects this combination of forces and determine how the forces change as the rotational speed of the turntable increases.

Section 11.2: Forces and circular motion

Example 11.3 Cube on a turntable (cont.)

③ EXECUTE PLAN To draw my free-body diagram, I must answer the question What are the forces exerted on the cube? First there is \vec{F}_{Ec}^G , the gravitational force exerted by Earth. This force is directed vertically downward and so cannot contribute to a force directed toward the turntable's center.

Section 11.2: Forces and circular motion

Example 11.3 Cube on a turntable (cont.)

③ EXECUTE PLAN The only other force exerted on the cube is \vec{F}_{sc}^c , the contact force exerted by the surface of the turntable.

The normal component \vec{F}_{sc}^n of this force must be equal in magnitude to \vec{F}_{Ec}^G because the cube does not accelerate in the vertical direction.

The horizontal component, which is the force of static friction \vec{F}_{sc}^s , is what forces the cube toward the center of its circular path.

Section 11.2: Forces and circular motion

Example 11.3 Cube on a turntable (cont.)

③ EXECUTE PLAN I therefore draw the free-body diagram shown in Figure 11.15*b*. Because the vertical component of the acceleration is zero, the forces in that direction add to zero. Thus the vector sum of the forces exerted on the cube equals the force of static friction.

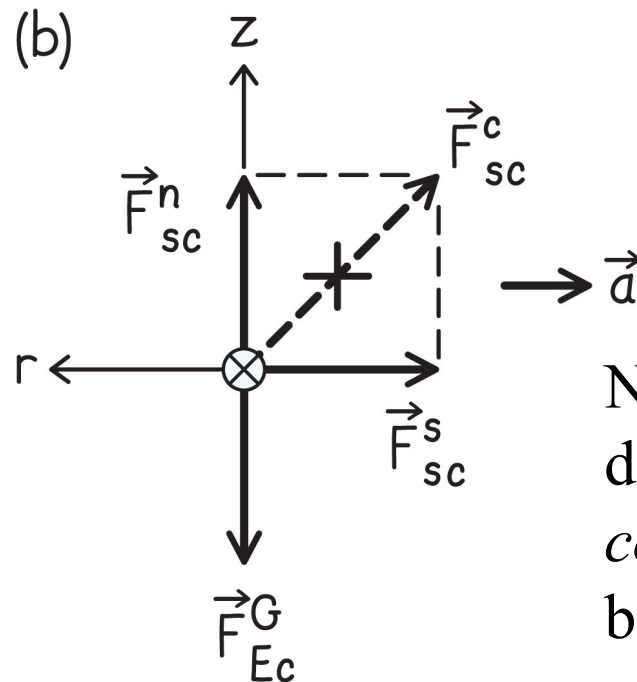

Note centripetal force doesn't appear! It is a *constraint* on the force balance, not a real force.

Section 11.2: Forces and circular motion

Example 11.3 Cube on a turntable (cont.)

3 EXECUTE PLAN As the rotational speed increases, the magnitude of the centripetal acceleration of the cube also increases. This means that the magnitude of the force of static friction must get larger. At some instant, this force reaches its maximum value and so can no longer increase even though the rotational speed continues to increase.

Section 11.2: Forces and circular motion

Example 11.3 Cube on a turntable (cont.)

3 EXECUTE PLAN Consequently, the vector sum of the forces exerted on the cube is no longer large enough to give it the centripetal acceleration required for its circular trajectory. When this happens, the distance between the cube and the axis of rotation increases until the cube slides off the edge. ✓

Section 11.2: Forces and circular motion

Example 11.3 Cube on a turntable (cont.)

4 EVALUATE RESULT What makes the cube slide off the turntable is its tendency to continue in a straight line (that is, on a trajectory tangent to its circular trajectory).

Up to a certain speed the force of static friction is large enough to overcome this tendency and keep the cube moving in a circle. Once the force of static friction reaches its maximum value, the cube begins to slide.

Forces and circular motion

Constraints & Newton's second law

- One half of Newton's second law: add up forces
- Other half: what is the constraint on the system?
 - now we know a new one: constraining the path constrains the force sum!
 - must be a function of v and R ... need to know more!
 - centripetal force is the *constraint on a force balance*, it is not drawn in the free body diagram

$$\sum \vec{F} = \begin{cases} 0 & \text{stationary / constant } v \\ ma & \text{generic motion} \\ f(v, R) & \text{known path} \end{cases}$$

Checkpoint 11.2



11.2 Suppose I have two cubes on a turntable at equal distances from the axis of rotation. The inertia of cube 1 is twice that of cube 2. Do both cubes begin sliding at the same instant if I slowly increase the rotational velocity?

force required to keep cube 1 in motion is twice as large, but it experiences a friction force twice as large.

everything scales with mass in the same way, so they begin sliding at the same instant

Section 11.2: Forces and circular motion

- The figure shows free-body diagrams for three objects moving in circular motion at constant speed.
- In each case the vector sum of the forces exerted on the object points toward the center of the trajectory. *Don't draw in centripetal force!*

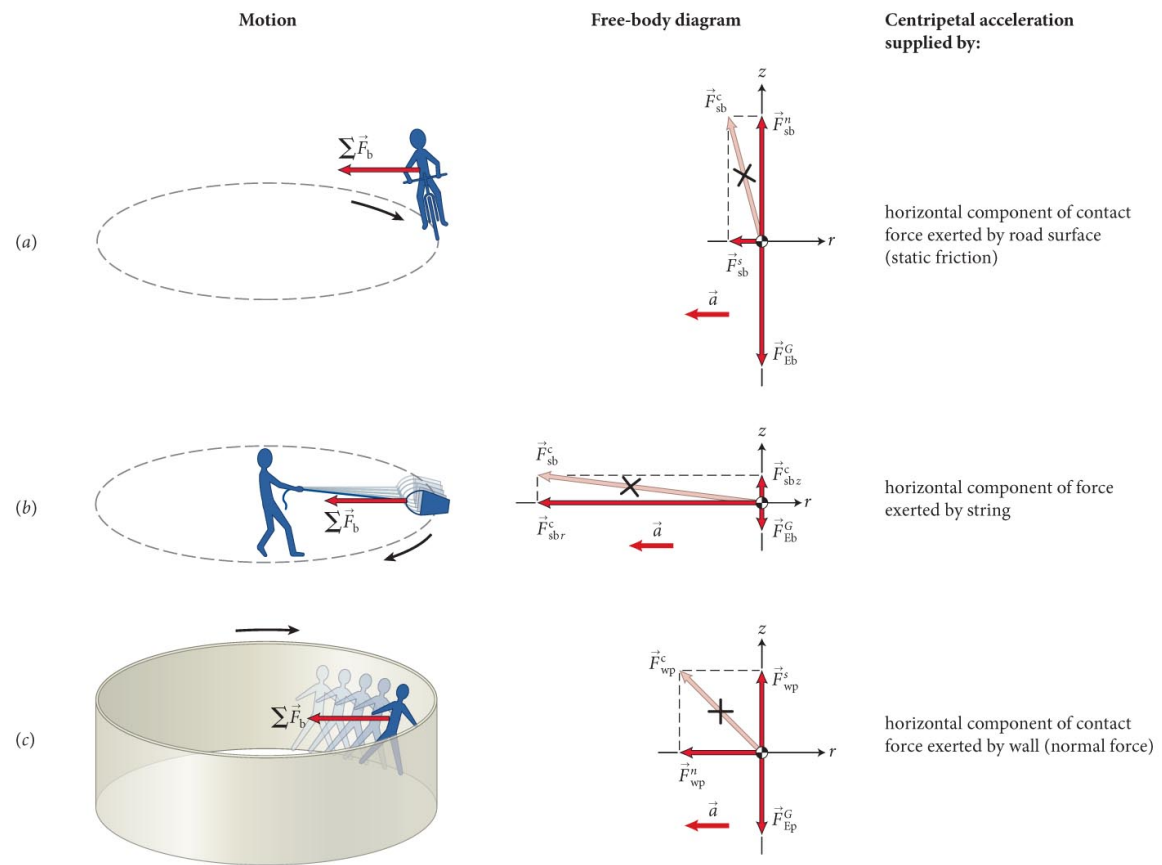

Checkpoint 11.3



11.3 (a) Does a bicycle always have to lean into a curve as illustrated in Figure 11.17a? (b) The rope holding the bucket in Figure 11.17b makes a small angle with the horizontal. Is it possible to swing the bucket around so that the rope is exactly horizontal?

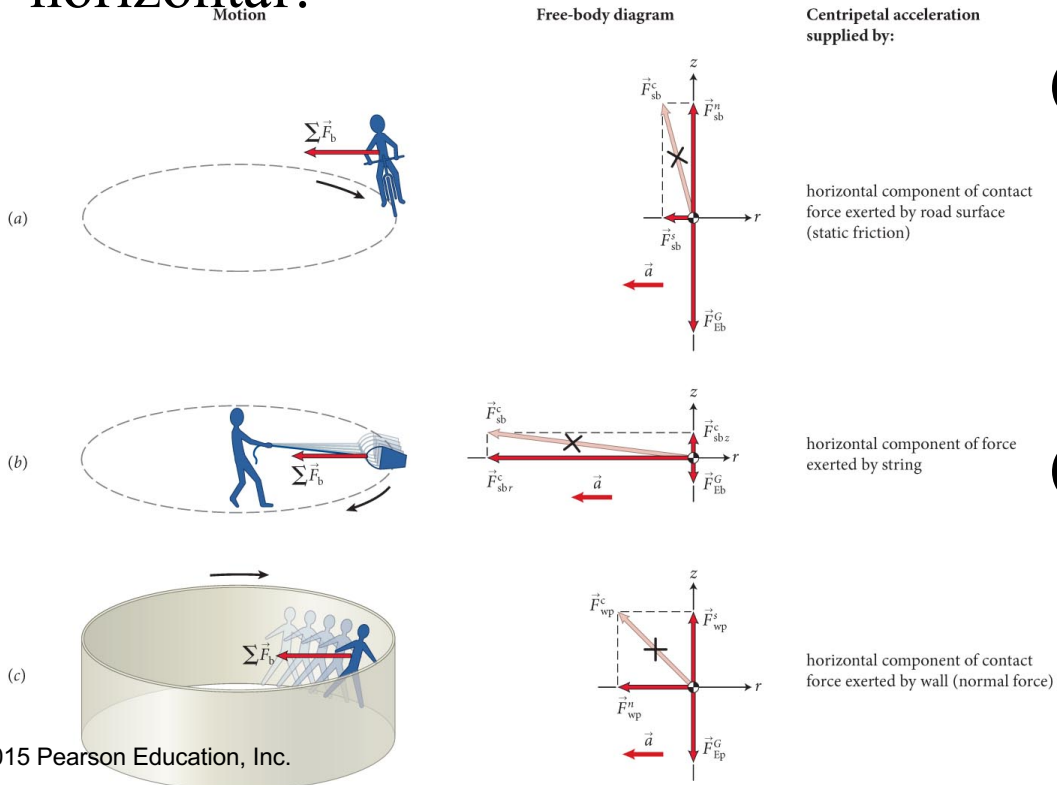

- (a) yes – this is the only way there is a horizontal component of the contact force to maintain a circular path
- (b) no – the vertical component of the string force keeps the bucket from falling!

Section 11.3: Rotational inertia

Section Goals

You will learn to

- Define rotational inertia as a generalization of the concept of inertia.
- Identify the factors that determine the rotational inertia for particles and extended objects.

Most of hammer's mass is in head.

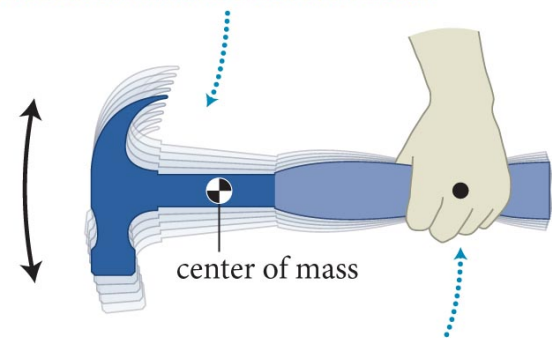

Axis of rotation far from center of mass:
Hammer is hard to rotate (has high rotational inertia).

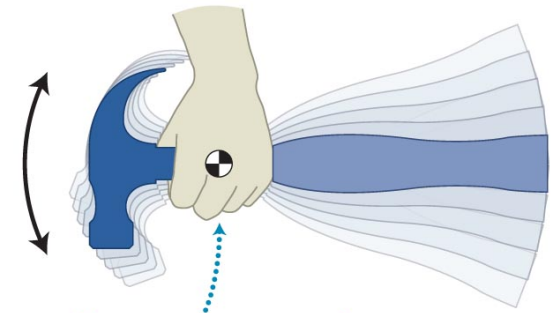

Axis of rotation at center of mass:
Hammer is easy to rotate (has low rotational inertia).

Section 11.3: Rotational inertia

- Consider the two experiments illustrated in the figure:
 - Pucks A, B and C are identical. Puck A traveling at speed v hits the stationary Pucks B and C in the two experiments.
 - B and C are fastened to two strings and are free to rotate.
 - We can conclude that the rotational speed of puck B is larger than the rotational speed of puck C.
 - It seems that puck C, having a trajectory with a larger radii than B, resists a change in its rotational velocity more than B.

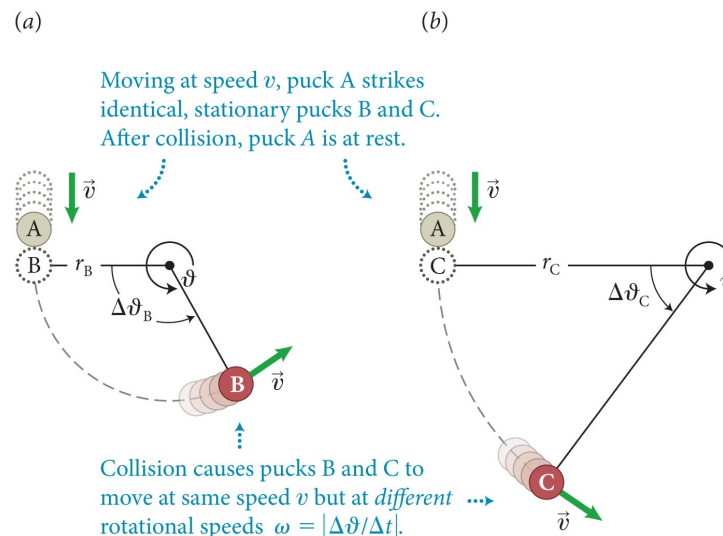

Section 11.3: Rotational inertia

- An object's tendency to resist a change in rotational velocity is called its **rotational inertia**.
- Consider the figure: It is easier to rotate a hammer if the axis of rotation is closer to the center of mass.
- We can conclude that the rotational inertia is not given simply by the object's inertia (m). It also depends on the location of the axis of rotation.

Most of hammer's mass is in head.

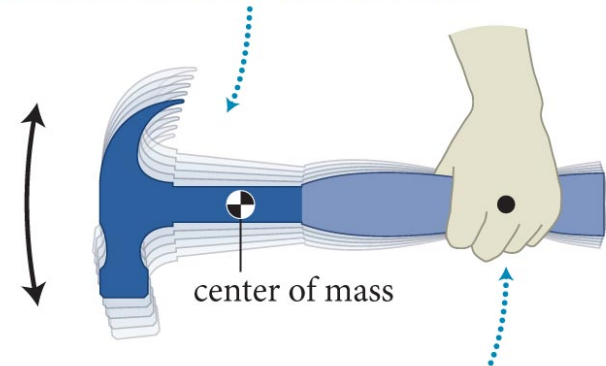

Axis of rotation far from center of mass:
Hammer is hard to rotate (has high rotational inertia).

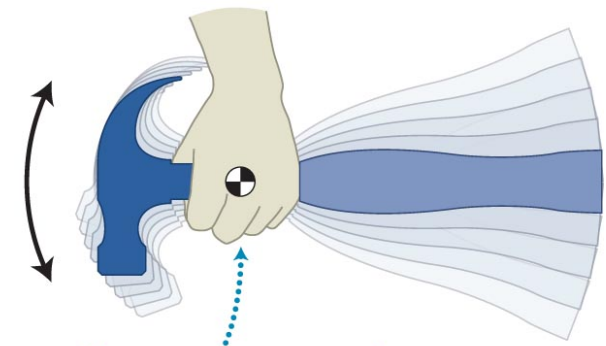

Axis of rotation at center of mass:
Hammer is easy to rotate (has low rotational inertia).

Checkpoint 11.4



11.4 About which axis is the rotational inertia of a pencil (*a*) largest and (*b*) smallest:

- (1) a lengthwise axis through the core of the pencil;
- (2) an axis perpendicular to the pencil's length and passing through its midpoint;
- (3) an axis perpendicular to the pencil's length and passing through its tip?

largest when most mass is farthest from center = 3

smallest when concentrated at center = 1

Section 11.3

Question 4

Is rotational inertia an intrinsic property of an object?

1. Yes
2. No

Section 11.3

Question 4

Is rotational inertia an intrinsic property of an object?

1. Yes

 2. No – depends on axis of rotation

Chapter 11: Self-Quiz #5

A ball attached to a string (the far end of which is fixed) rolls in a horizontal circle. Under which conditions is the string more likely to break?

- (a) When the speed of the ball is increased for a given radius
- (b) When the length of the string is increased for a given speed

Chapter 11: Self-Quiz #5

Answer

In case a , for a given radius, a greater speed means the ball travels through a larger angle during a specific time interval. If the angle is larger, the magnitude of \vec{v} is larger. A larger magnitude of \vec{v} requires that the acceleration and force also be larger.

The force providing the acceleration is due to the tension in the string. Therefore, the greater speed requires more tension and the string is more likely to break. (the opposite conclusion is absurd ...)

Chapter 11: Self-Quiz #5

Answer

In case b , for a given speed, a larger radius means that the ball travels through a smaller angle in a specific time interval. If the angle is smaller, the magnitude of \vec{v} is smaller. A smaller \vec{v} requires a smaller acceleration and a smaller force.

Therefore, a large radius requires a smaller tension in the string and the string is less likely to break.

Chapter 11: Motion in a Circle

Quantitative Tools

Section 11.4: Motion in a Circle

- The rotational coordinate (ϑ) is defined as (a)

$$\vartheta \equiv \frac{s}{r}$$

The sign and magnitude of s (and ϑ) depend on the choice of rotational coordinate system

- ϑ is unitless. In contrast, the polar angle θ can be expressed in radians, degrees, or revolutions, where

$$2\pi \text{ rad} = 360^\circ = 1 \text{ rev}$$

- Given θ we can obtain ϑ from: $\vartheta = \theta / (1 \text{ rad})$.
- The change in the rotational coordinate $\Delta\vartheta$ is given by

$$\Delta\vartheta = \vartheta_f - \vartheta_i = \frac{s_f}{r} - \frac{s_i}{r} = \frac{\Delta s}{r}$$

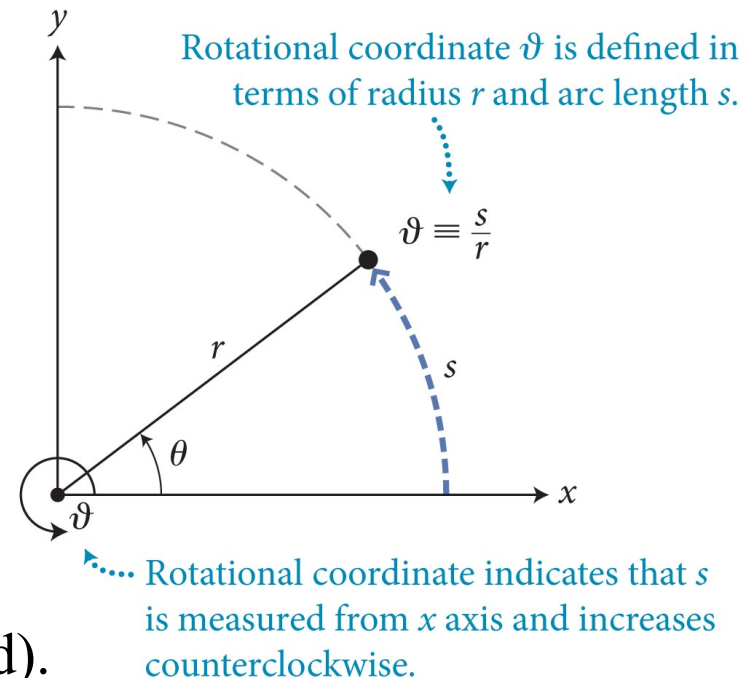

yes, this is a bit pedantic

Checkpoint 11.5



11.5 Starting from a position with rotational coordinate zero, an object moves in the positive θ direction at a constant speed of 3.0 m/s along the perimeter of a circle of radius 2.0 m.

- (a) What is the object's rotational coordinate after 1.5 s?
- (b) How long does it take the object to complete one revolution

Checkpoint 11.5



11.5 Starting from a position with rotational coordinate zero, an object moves in the positive θ direction at a constant speed of 3.0 m/s along the perimeter of a circle of radius 2.0 m.

(a) What is the object's rotational coordinate after 1.5 s?

in 1.5s, covers an arclength of $s = (3\text{m/s})(1.5\text{s}) = 4.5\text{m}$

$$\theta = s/r = (4.5\text{m})/(2.0\text{m}) = 2.3$$

(b) How long does it take the object to complete one revolution

perimeter is $C = 2\pi(2.0\text{m})$, at 3m/s this takes

$$t = C/v = 2\pi(2.0\text{m})/(3.0\text{m/s}) = 4.2\text{s}$$

Section 11.4: Motion in a Circle

- The **rotational velocity** is defined as:

$$\omega_{\vartheta} \equiv \lim_{\Delta t \rightarrow 0} \frac{\Delta \vartheta}{\Delta t} = \frac{d\vartheta}{dt}$$

- The **rotational speed** is $\omega = |\omega_{\vartheta}|$.
- Given this,

$$\omega = \frac{d\theta}{dt} = \frac{d}{dt} \left(\frac{s}{R} \right) = \frac{1}{R} \frac{ds}{dt} = \frac{v_t}{R}$$

$$v_t = \frac{ds}{dt} = R\omega$$

- The tangential component of velocity (v_t) and ω_{ϑ} are signed quantities, positive in the direction of increasing ϑ (CCW)

(b)

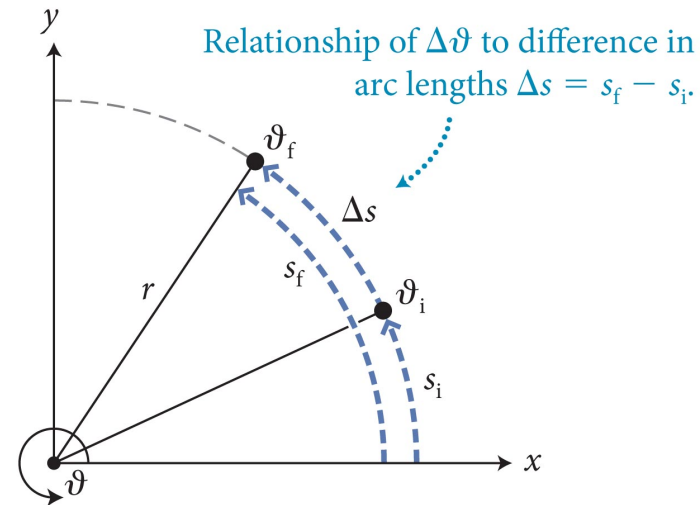

Everyday analogy:
 $\omega = \text{rpm}$

Section 11.4: Motion in a Circle

- The **rotational acceleration** is defined as

$$\alpha_{\vartheta} \equiv \lim_{\Delta t \rightarrow 0} \frac{\Delta \omega_{\vartheta}}{\Delta t} = \frac{d\omega_{\vartheta}}{dt} = \frac{d^2\vartheta}{dt^2}$$

- By analyzing the two similar triangles shown in the figure, we can show that the magnitude of the **centripetal acceleration** to be

$$a_c = \frac{v^2}{r} \quad (\text{circular motion})$$

- Using the definition of the radial axis (see bottom figure), we can write

$$a_r = -\frac{v^2}{r} \quad (\text{any motion along arc of radius } r)$$

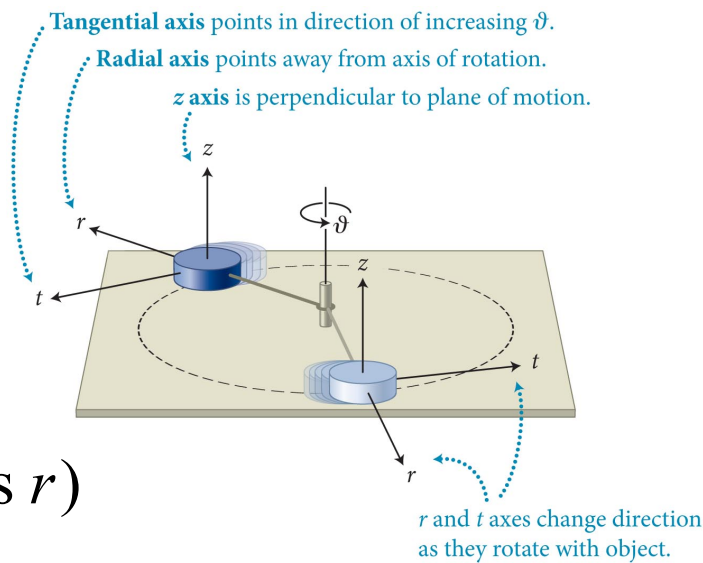
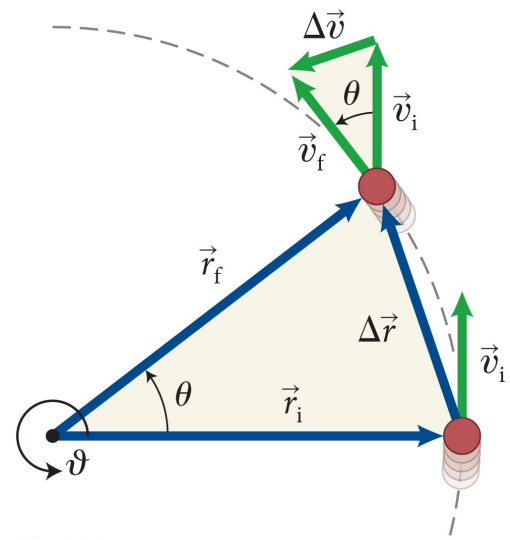

Section 11.4 Motion in a circle

- How to use similar triangles?
- Ratio of similar sides is the same

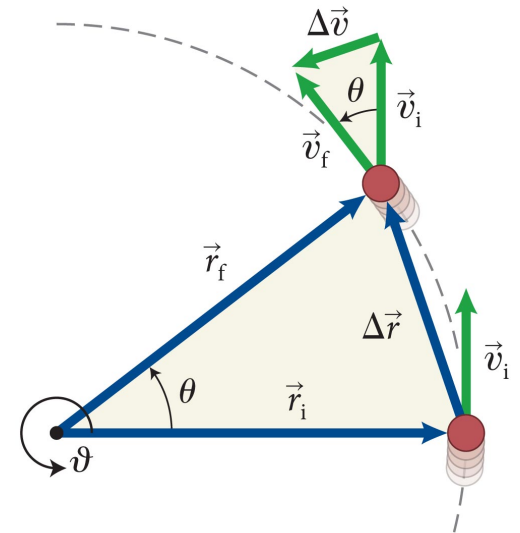

$$\frac{|\Delta \vec{r}|}{r} = \frac{|\Delta \vec{v}|}{v}$$

rearrange, divide by Δt

$$\frac{|\Delta \vec{v}|}{\Delta t} = \frac{v}{r} \frac{|\Delta \vec{r}|}{\Delta t}$$

LHS is acceleration, $\Delta \vec{r}/\Delta t \rightarrow \vec{v}$

$$a_c = \frac{v^2}{r}$$

Forces and circular motion

Constraints & Newton's second law, again

- Our constraint is now more specific:

$$\sum \vec{F} = \begin{cases} 0 & \text{stationary / constant } v \\ ma & \text{generic motion} \\ m \frac{v^2}{r} & \text{circular path (const. speed)} \end{cases}$$

(not just circles either: replace r with generalized radius of curvature at a point on a curve. Cal III ...)

Section 11.4: Motion in a Circle

- For circular motion at **constant speed**:

$$v_r = 0 \text{ and } a_r = -v^2/r.$$

- When the object's speed is not constant, there is a **tangential acceleration** component given by

$$a_t = \frac{dv_t}{dt} = r \frac{d\omega_\vartheta}{dt}$$

- Or, using $\alpha_\vartheta = d\omega_\vartheta/dt$

$$a_t = r\alpha_\vartheta$$

- So, if the object in circular motion speeds up or slows down, the magnitude of acceleration is

$$a = \sqrt{a_r^2 + a_t^2}$$

(b) Circular motion at increasing speed

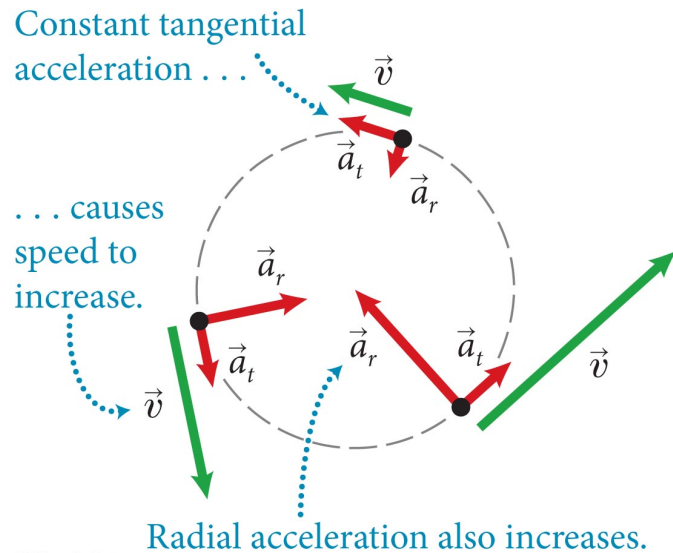

(c) Acceleration during circular motion

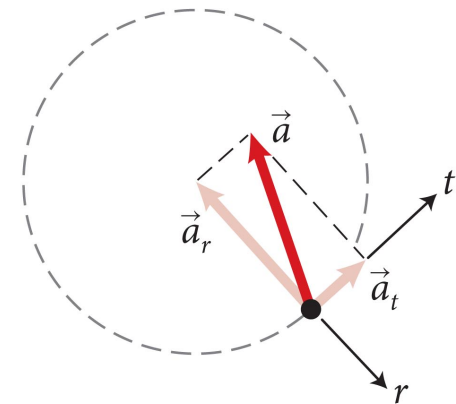

Section 11.4: Motion in a Circle

- The relationship between rotational and translational motion quantities can be given as

translational motion quantity = (r)(rotational motion quantity)

Table 11.1

$$s = r\vartheta \quad (11.1)$$

$$v_t = r\omega_\vartheta \quad (11.10)$$

$$a_t = r\alpha_\vartheta \quad (11.23)$$

- Using the kinematic equations developed in Chapter 3, we can obtain the equivalent kinematic equations for rotational motion with constant rotational acceleration (α_t):

$$\vartheta_f = \vartheta_i + \omega_{\vartheta,i}\Delta t + \frac{1}{2}\alpha_\vartheta(\Delta t)^2 \quad (\text{constant rotational acceleration})$$

$$\omega_{\vartheta,f} = \omega_{\vartheta,i} + \alpha_\vartheta\Delta t \quad (\text{constant rotational acceleration})$$

Rotational vs translational motion

- Think about this for a minute.

Table 11.1

$$s = r\vartheta \quad (11.1)$$

$$v_t = r\omega_{\vartheta} \quad (11.10)$$

$$a_t = r\alpha_{\vartheta} \quad (11.23)$$

- You already know all the equations & techniques for rotational kinematics
- You already learned it for 1D motion
- Only the letters have changed. Same equations, same solutions. Just multiply/divide by r .

Section 11.4: Motion in a Circle

- Works pretty much across the board

Table 11.2 Translational and rotational kinematics

Translational motion (constant acceleration)		Rotational motion (constant rotational acceleration)	
coordinate	x	rotational coordinate	ϑ
x component of displacement	$\Delta x = x_f - x_i$	change in rotational coordinate	$\Delta \vartheta = \vartheta_f - \vartheta_i$
x component of velocity	$v_x = \frac{dx}{dt}$	rotational velocity	$\omega_\vartheta = \frac{d\vartheta}{dt}$
x component of acceleration	$a_x = \frac{dv_x}{dt} = \frac{d^2x}{dt^2}$	rotational acceleration	$\alpha_\vartheta = \frac{d\omega_\vartheta}{dt} = \frac{d^2\vartheta}{dt^2}$
kinematics relationships (constant a_x):	$v_{x,f} = v_{x,i} + a_x \Delta t$ $x_f = x_i + v_{x,i} \Delta t + \frac{1}{2} a_x (\Delta t)^2$	rotational kinematics relationships (constant α_ϑ):	$\omega_{\vartheta,f} = \omega_{\vartheta,i} + \alpha_\vartheta \Delta t$ $\vartheta_f = \vartheta_i + \omega_{\vartheta,i} \Delta t + \frac{1}{2} \alpha_\vartheta (\Delta t)^2$
		radial acceleration	$a_r = -\frac{v^2}{r} = -r\omega^2$
		tangential acceleration	$a_t = 0$

PRINCIPLES & PRACTICE OF
PHYSICS

ERIC MAZUR

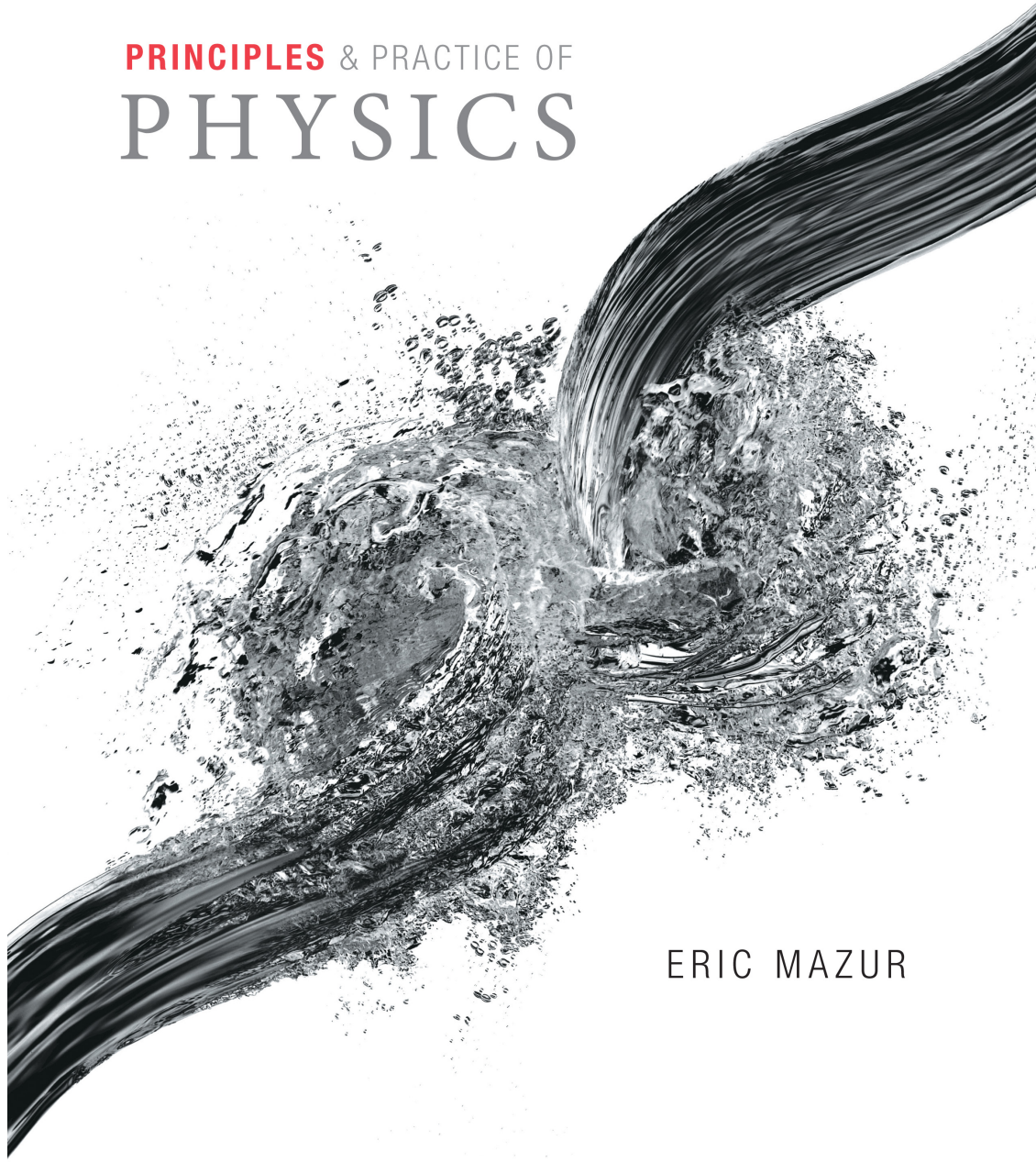

Hyatt Regency walkway collapse

- Original design: contractor objected, since it required the whole of the rod below the fourth floor to be screw threaded in order to screw on the nuts to hold the fourth floor walkway in place.
- Alternate plan: two offset rods.
- Why is this a problem?

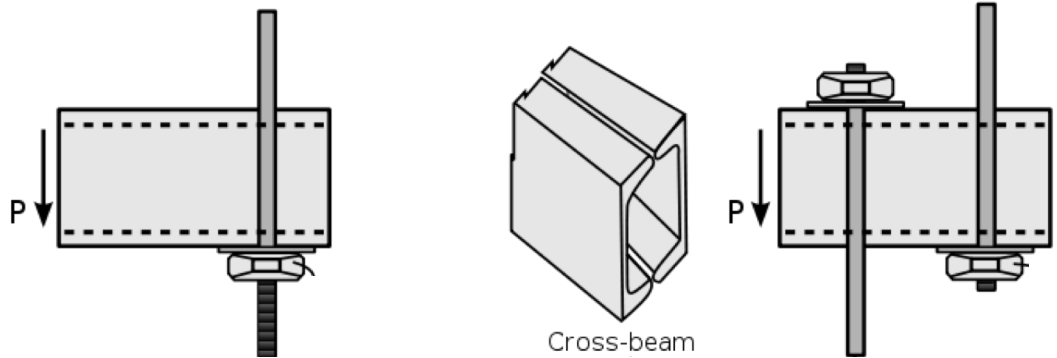

(a) Original design

(b) Actual construction

Hyatt Regency walkway collapse

- **original design:** beams of the 4th floor walkway support only the weight of the 4th floor walkway, second floor walkway supported completely by the rods.
- **revised design:** 4th floor beams supports 4th floor walkway **and** 2nd floor walkway hanging from it. Nut has twice the stress!

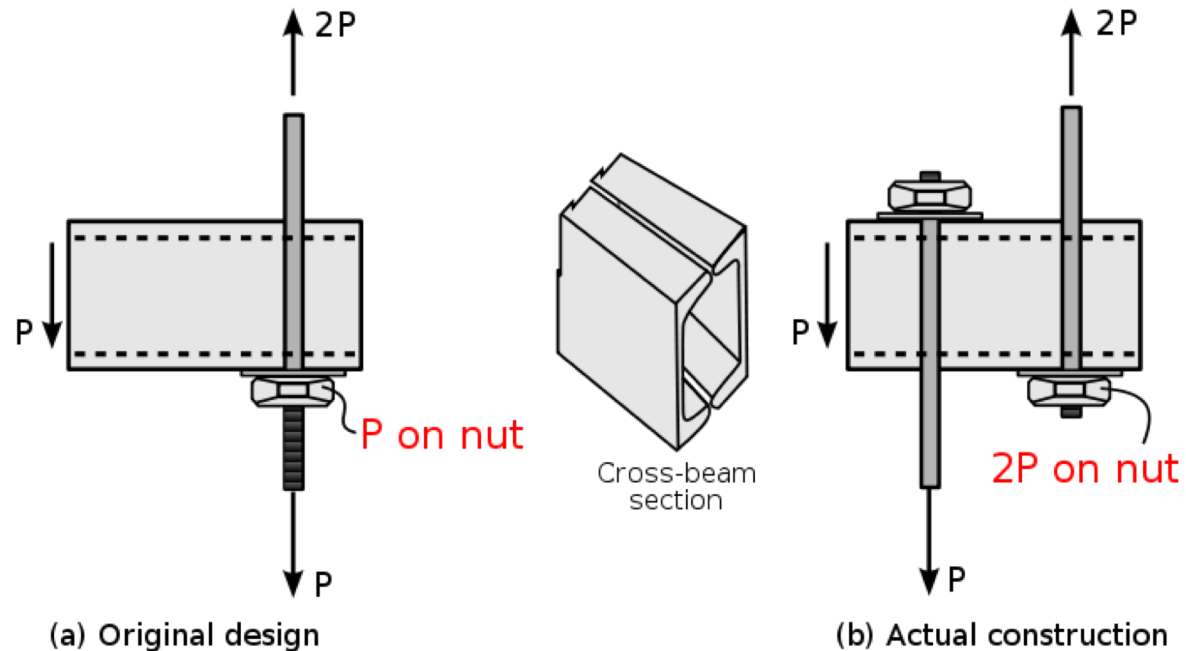

Section 11.4: Rotational kinematics

Example 11.4 Leaning into a curve

A woman is rollerblading to work and, running late, rounds a corner at full speed, sharply leaning into the curve (Figure 11.25). If, during the turn, she goes along the arc of a circle of radius 4.5 m at a constant speed of 5.0 m/s, what angle θ must her body make with the vertical in order to round the curve without falling?



Section 11.4: Rotational kinematics

Example 11.4 Leaning into a curve (cont.)

1 GETTING STARTED As she rounds the circular arc at constant speed, the woman executes circular motion at constant speed.

She must therefore undergo a centripetal acceleration as a result of the forces exerted on her. Draw a free-body diagram (Figure 11.26).

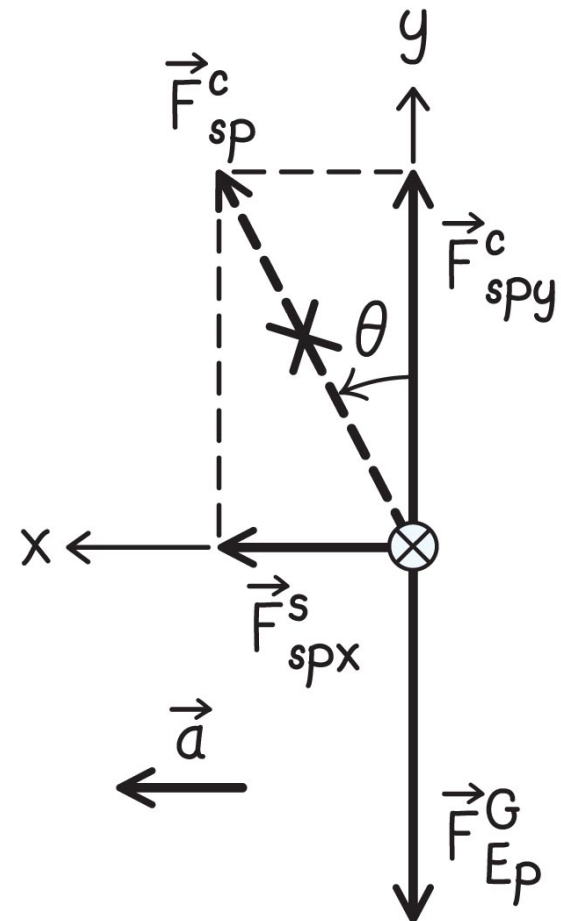

Section 11.4: Rotational kinematics

Example 11.4 Leaning into a curve (cont.)

1 GETTING STARTED The forces exerted on the rollerblader are the gravitational force \vec{F}_{Ep}^G and a contact force \vec{F}_{sp}^c exerted by the surface of the road.

Now I see why she must lean into the turn: When she stands straight, the contact force is directed straight up, but as she leans, this force develops a component that pushes her toward the center of the circular arc and provides the necessary centripetal acceleration.

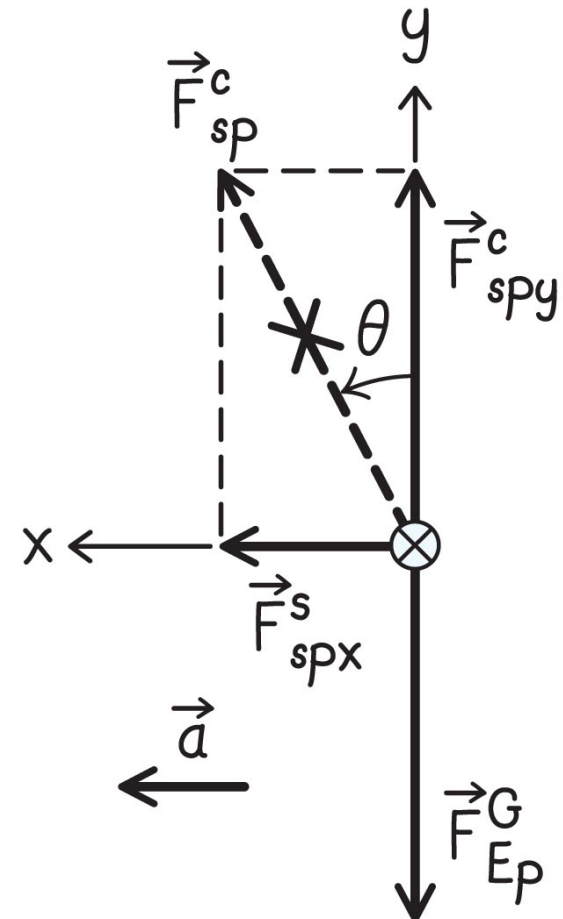

Section 11.4: Rotational kinematics

Example 11.4 Leaning into a curve (cont.)

1 GETTING STARTED I indicate the direction of this centripetal acceleration in my drawing and choose a set of axes—the x axis in the direction of the centripetal acceleration and the y axis upward.

I must determine the angle θ that \vec{F}_{sp}^c makes with the vertical.

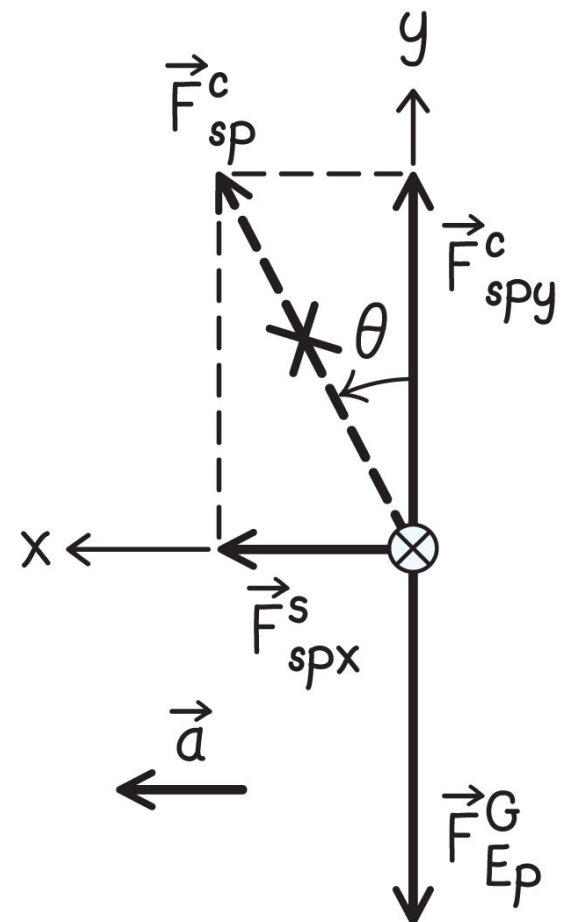

Section 11.4: Rotational kinematics

Example 11.4 Leaning into a curve (cont.)

② DEVISE PLAN From my free-body diagram, I can draw two conclusions.

First, the forces in the y direction must add to zero:

$$\Sigma F_y = 0.$$

Second, the x component of the contact force provides the centripetal acceleration. This gives me two equations from which I should be able to determine θ .

Section 11.4: Rotational kinematics

Example 11.4 Leaning into a curve (cont.)

③ EXECUTE PLAN Substituting the centripetal acceleration into the equation of motion in the x direction,

$$\Sigma F_x = ma_x = m(+a_c) = +m\frac{v^2}{r}, \quad (1)$$

where m is the inertia of the rollerblader. The $+$ sign is consistent with my choice of axes.

(The rollerblader's inertia is not given, but I hope it will drop out and I won't need it.)

Section 11.4: Rotational kinematics

Example 11.4 Leaning into a curve (cont.)

③ EXECUTE PLAN From my diagram, I see that

$$\Sigma F_x = F_{sp,x}^c = F_{sp}^c \sin \theta. \quad (2)$$

In the y direction I have $F_{sp,y}^c = F_{sp}^c \cos \theta$ and $F_{Ep,y}^G = -mg$.

The equation of motion in the y direction gives

$$\Sigma F_y = F_{sp,y}^c + F_{Ep,y}^G = F_{sp}^c \cos \theta - mg = 0.$$

Note the *constraint* for y is zero, it was not for x

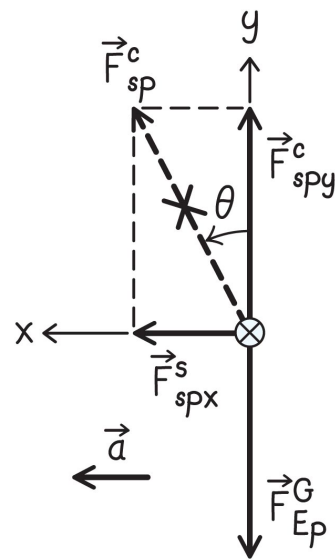

Section 11.4: Rotational kinematics

Example 11.4 Leaning into a curve (cont.)

3 EXECUTE PLAN Solving this equation for F_{sr}^{c} and substituting the result into Eq. 2, I get

$$\Sigma F_x = F_{\text{sp}}^{\text{c}} \sin \theta = \left(\frac{mg}{\cos \theta} \right) \sin \theta = mg \tan \theta.$$

Section 11.4: Rotational kinematics

Example 11.4 Leaning into a curve (cont.)

③ EXECUTE PLAN Substituting this result into Eq. 1 then yields

$$mg \tan \theta = m \frac{v^2}{r}$$

$$\tan \theta = \frac{v^2}{gr} = \frac{(5.0 \text{ m/s})^2}{(9.8 \text{ m/s}^2)(4.5 \text{ m})} = 0.57.$$

This gives an angle $\theta = \tan^{-1}(0.57) = 0.52 \text{ rad}$, or about 30° . ✓

Section 11.4: Rotational kinematics

Example 11.4 Leaning into a curve (cont.)

④ EVALUATE RESULT The angle of the skater in Figure 11.25 is about 30° , and so my answer appears to be reasonable.

It also seems plausible from everyday experience.

Section 11.5: Angular momentum

Section Goals

You will learn to

- Generalize the concepts of momentum, inertia, and kinetic energy to rotational cases.
- Relate the equations for translational momentum and kinetic energy to rotational situations.
- Apply the law of the conservation of angular momentum.

Section 11.5: Angular momentum

- Let us consider the following experiment: A stationary puck C fastened to a string of length r is struck by an identical puck moving at speed v . Treating the puck C as a particle,

- its kinetic energy can be written as

$$K = \frac{1}{2}mv^2 = \frac{1}{2}m(r\omega)^2 = \frac{1}{2}(mr^2)\omega^2$$

- Defining the term in the parenthesis as the **rotational inertia** I of the particle about the axis of rotation, $I = mr^2$, we get

$$K_{\text{rot}} = \frac{1}{2}I\omega^2 \quad (b)$$

where K_{rot} is the **rotational kinetic energy**.

- The SI units of I are kg - m².
- I is the analog of inertia/mass for rotation

Moving at speed v , puck A strikes identical, stationary pucks B and C. After collision, puck A is at rest.

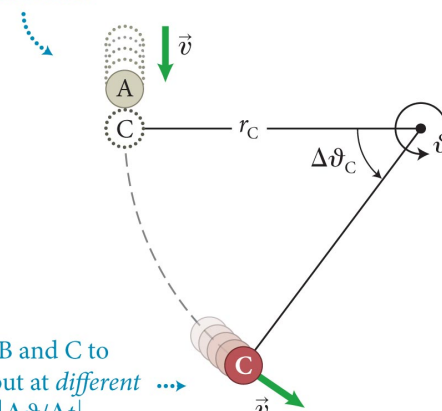

Collision causes pucks B and C to move at same speed v but at different rotational speeds $\omega = |\Delta\theta/\Delta t|$.

Section 11.5: Angular momentum

- Consider the two collisions below: In both cases the rods and pucks are identical and the puck has the same initial velocity.
 - need an analog of $p \dots$ how about $mv \rightarrow I\omega$?
 - for the puck, using $I = mr^2$ and $\omega = v/r$, we get $I\omega = rmv$.
 - we can conclude that the larger the value of $I\omega$ (as in case *a*), the more easily the object can set another object in rotation.

(a) Puck strikes rod far from rotation axis

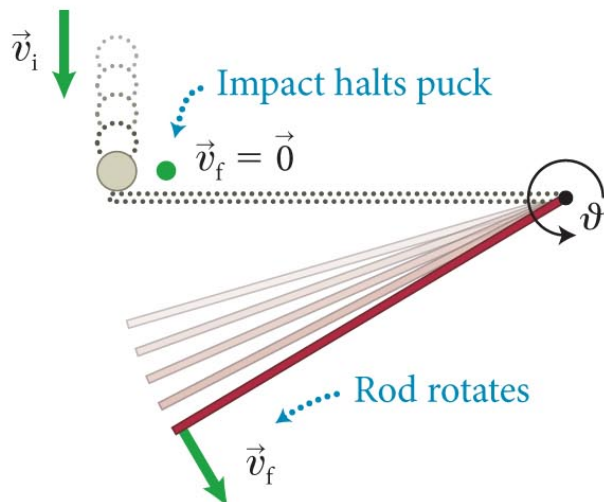

(b) Puck strikes rod closer to rotation axis

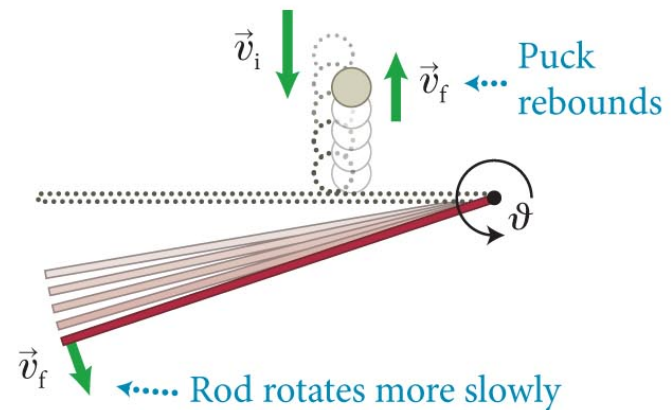

Section 11.5: Angular momentum

- The quantity $L_{\vartheta} = I\omega_{\vartheta}$ is called the **angular momentum**,

$$L_{\vartheta} \equiv I\omega_{\vartheta} = (mr^2) \left(\frac{v_t}{r} \right) = rmv_t$$

- As fundamental as linear momentum – analog for rotation
- The SI units of L are: kg - m²/s.
- Momentum *and* distance from pivot matter

(a) Puck strikes rod far from rotation axis

(b) Puck strikes rod closer to rotation axis

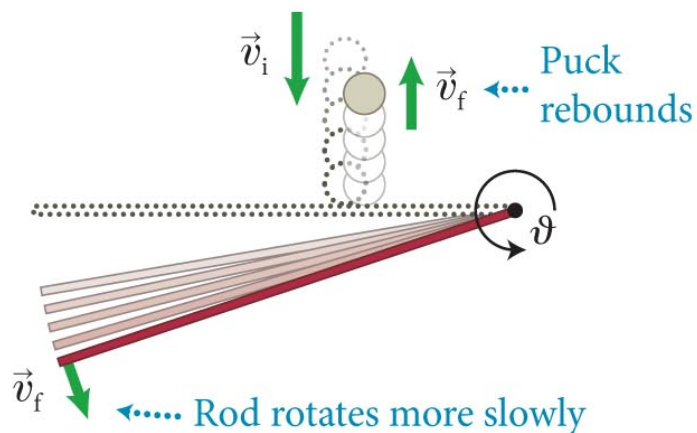
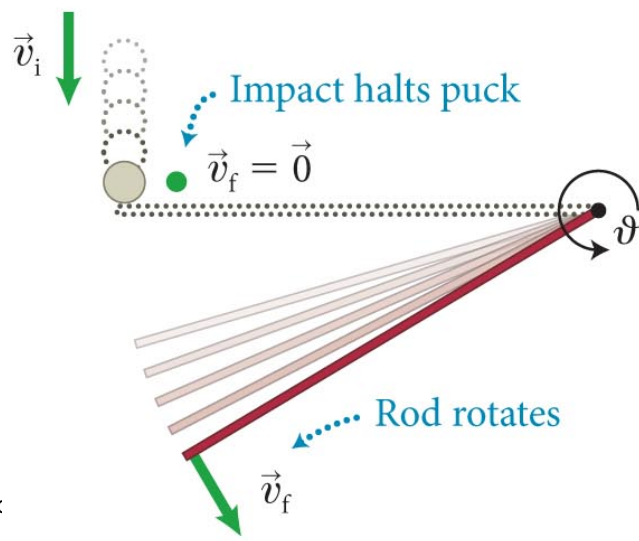

Section 11.5: Angular momentum

- As illustrated in the figure, the object does not have to rotate or revolve to have a nonzero L .
 - r_{\perp} is called the **lever arm**.
 - the angular momentum of a particle that moves in a straight line is

$$L = r_{\perp}mv \text{ (particle)}$$

$$\text{-or- } L = rmv_t \text{ (particle)}$$

(implies cross product of r & v ...)

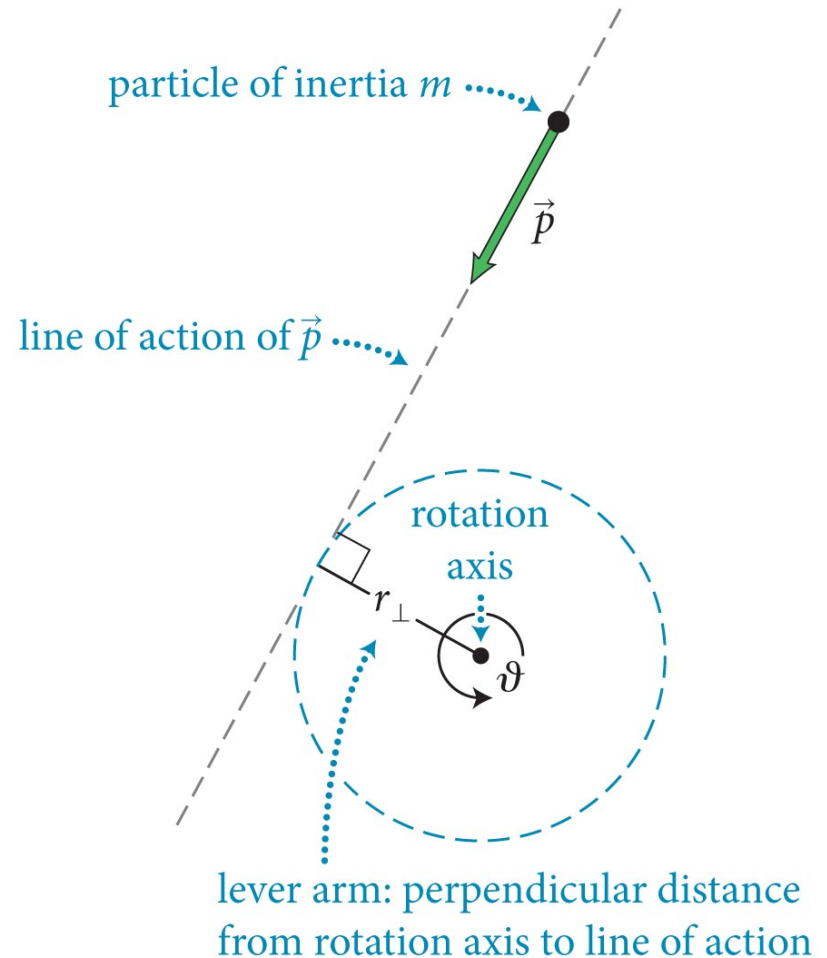

Section 11.5: Angular momentum

- Consider the particle in circular motion shown in the figure:
 - The radial component of the force keeps the particle moving in a circle.
 - The tangential component causes the particle's angular momentum to change (changes v)
 - In the absence of the tangential component, the angular momentum remains constant.

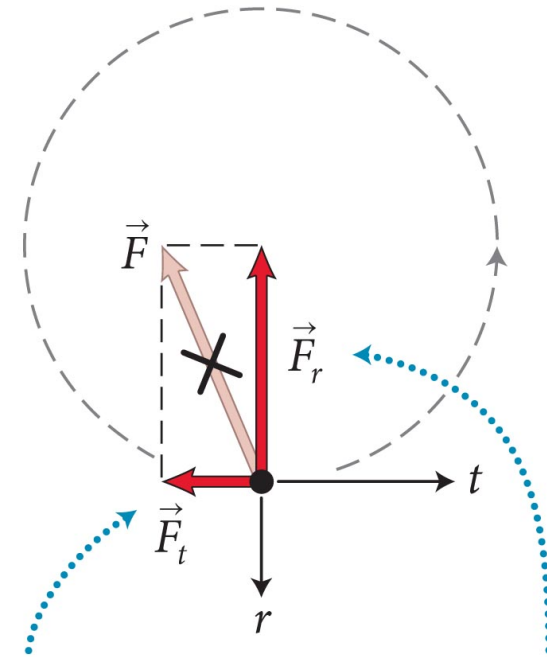

Tangential component
changes speed and
angular momentum.

Radial component
causes centripetal
acceleration.

Section 11.5: Angular momentum

- This observation leads us to the law of **conservation of angular momentum**:
 - **Angular momentum can be transferred from one object to another, but it cannot be created or destroyed.**
- In the absence of tangential forces (isolated)

$$\Delta L_{,g} = 0 \quad (\text{no tangential forces})$$

Section 11.5: Angular momentum

Exercise 11.6 Spinning faster

Divers increase their spin by tucking in their arms and legs (Figure 11.32). Suppose the outstretched body of a diver rotates at 1.2 revolutions per second before he pulls his arms and knees into his chest, reducing his rotational inertia from $9.4 \text{ kg} \cdot \text{m}^2$ to $3.1 \text{ kg} \cdot \text{m}^2$. What is his rotational velocity after he tucks in his arms and legs?



Section 11.5: Angular momentum

Exercise 11.6 Spinning faster (cont.)

SOLUTION Once the diver is off the board, the only force exerted on him is the gravitational force exerted by Earth. This force does not affect the angular momentum of the diver (dropped objects do not spontaneously start to rotate), and so his angular momentum must remain constant.

Section 11.5: Angular momentum

Exercise 11.6 Spinning faster (cont.)

SOLUTION If his angular momentum before he tucks is $L_{\vartheta,i}$ and that after is $L_{\vartheta,f}$, then

$$L_{\vartheta,f} = L_{\vartheta,i}$$

$$I_f \omega_{\vartheta,f} = I_i \omega_{\vartheta,i}$$

and so, from Eq. 11.34,

$$\begin{aligned}\omega_{\vartheta,f} &= \frac{I_i}{I_f} \omega_{\vartheta,i} \\ &= \frac{9.4 \text{ kg} \cdot \text{m}^2}{3.1 \text{ kg} \cdot \text{m}^2} (1.2 \text{ s}^{-1}) = 3.6 \text{ s}^{-1}. \checkmark\end{aligned}$$

Checkpoint 11.8



11.8 Does the rotational kinetic energy of the diver in Exercise 11.6 change as he pulls her arms in? Explain.

Yes – pulls more mass in closer to center of rotation, so easier to spin.

Because his arms' centripetal acceleration must increase as he pulls them in, the force required to pull them in increases. This requires more work to be done, using his chemical energy.

Section 11.5: Angular momentum

Example 11.7 Dumbbell collision

In Figure 11.33, two identical pucks B and C, each of inertia m , are connected by a rod of negligible inertia and length ℓ that is free to rotate about a fixed axis through its center. A third identical puck A, initially moving at speed v_i , strikes the combination as shown. After the elastic collision, what are the rotational velocity of the dumbbell and the velocity of puck A?

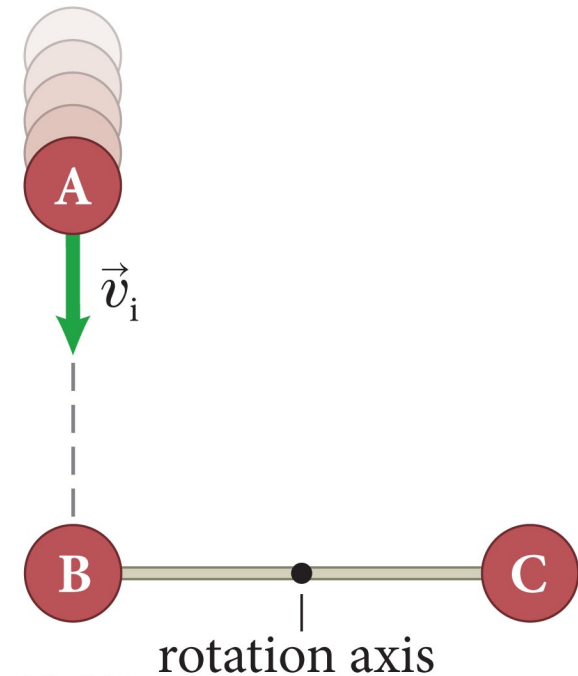

Section 11.5: Angular momentum

Example 11.7 Dumbbell collision (cont.)

① GETTING STARTED I begin with a two-part sketch (Figure 11.34), choosing an x axis in the direction of A's initial motion and choosing counterclockwise as the positive direction of rotation (this is the direction in which I expect the dumbbell to rotate after the collision).

initial

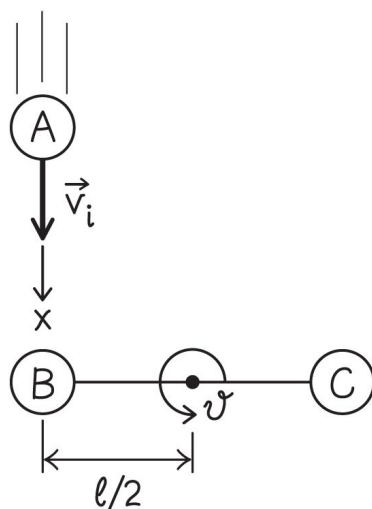

final

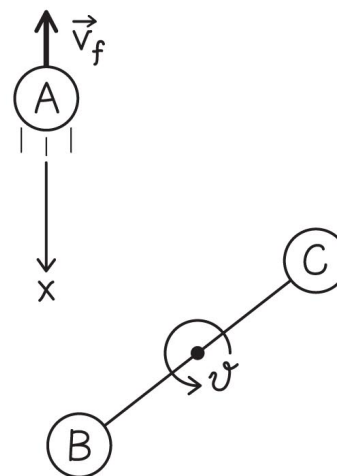

Section 11.5: Angular momentum

Example 11.7 Dumbbell collision (cont.)

1 GETTING STARTED Because A hits B head-on and because the inertia of the dumbbell is twice that of A, I expect A to bounce back and move in the negative x direction after the collision, as my after-collision sketch shows.

initial

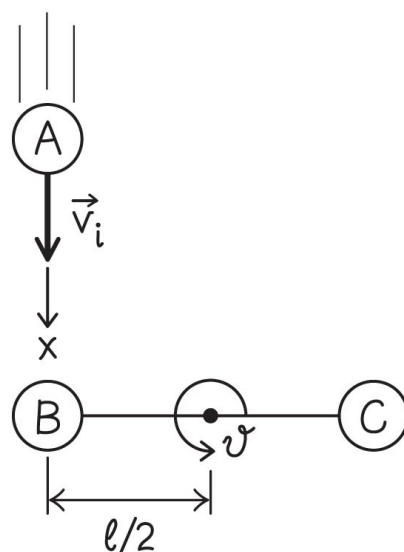

final

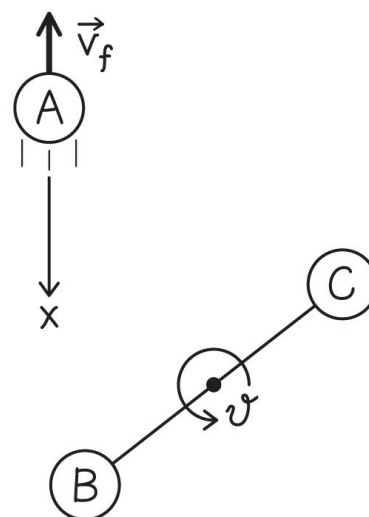

Section 11.5: Angular momentum

Example 11.7 Dumbbell collision (cont.)

② **DEVISE PLAN** In elastic collisions the kinetic energy of the system remains constant (see Section 5.5). In this collision I need to consider kinetic energy of puck A and rotational kinetic energy of the dumbbell.

Because there are two unknowns—A's final velocity and the dumbbell's final rotational velocity—I need an additional law to determine both. We can use conservation of angular momentum to the system comprising puck A and the dumbbell.

Just like linear collisions – conserve energy & momentum

Section 11.5: Angular momentum

Example 11.7 Dumbbell collision (cont.)

3 EXECUTE PLAN The initial kinetic energy of the system is that of puck A, $\frac{1}{2}mv_i^2$. The final kinetic energy is the sum of the (translational) final kinetic energy of A and the rotational kinetic energy of the dumbbell, $K_f = \frac{1}{2}mv_f^2 + \frac{1}{2}I\omega_f^2$, where I is the rotational inertia of the dumbbell.

Section 11.5: Angular momentum

Example 11.7 Dumbbell collision (cont.)

③ EXECUTE PLAN Ignoring the negligible inertia of the rod, I can say that each puck in the dumbbell contributes a rotational inertia $m(\ell/2)^2$ given by Eq. 11.30, so that the rotational inertia of the dumbbell is

$$I = 2m(\ell / 2)^2 = \frac{1}{2}m\ell^2. \quad (1)$$

Section 11.5: Angular momentum

Example 11.7 Dumbbell collision (cont.)

③ EXECUTE PLAN Because the collision is elastic, the final kinetic energy must equal the initial kinetic energy, and so $K_i = K_{f,trans} + K_{f,rot}$

$$\frac{1}{2} m v_i^2 = \frac{1}{2} m v_f^2 + \frac{1}{2} I \omega_i^2 = \frac{1}{2} m v_f^2 + \frac{1}{2} \left(\frac{1}{2} m \ell^2 \right) \omega_f^2,$$

where I have substituted for I the expression I obtained in Eq. 1. Dividing both sides by $\frac{1}{2} m$ gives $v_i^2 = v_f^2 + \frac{1}{2} \ell^2 \omega_f^2$.

Section 11.5: Angular momentum

Example 11.7 Dumbbell collision (cont.)

3 EXECUTE PLAN Because puck A moves along the x axis, $v_i^2 = v_{x,i}^2$ and $v_f^2 = v_{x,f}^2$. Because $\omega_f^2 = \omega_{\vartheta,f}^2$ I get

$$v_{x,i}^2 = v_{x,f}^2 + \frac{1}{2} \ell^2 \omega_{\vartheta,f}^2. \quad (2)$$

Section 11.5: Angular momentum

Example 11.7 Dumbbell collision (cont.)

③ EXECUTE PLAN Next I turn to conservation of angular momentum. The change in A's angular momentum is

$$\begin{aligned}\Delta L_{A\vartheta} &= L_{A\vartheta,f} - L_{A\vartheta,i} = (\ell/2)mv_{x,f} - (\ell/2)mv_{x,i} \\ &= (\ell/2)m(v_{x,f} - v_{x,i}).\end{aligned}$$

like with p , direction matters!

Section 11.5: Angular momentum

Example 11.7 Dumbbell collision (cont.)

3 EXECUTE PLAN The initial angular momentum of the dumbbell $L_{d\vartheta,i}$ about the rotation axis is zero; its final angular momentum about this axis is, from Eq. 11.34, $L_{d\vartheta,f} = I\omega_{\vartheta,i}$. The change in the dumbbell's angular momentum is thus

$$\Delta L_{d\vartheta} = I\omega_{\vartheta,f} - 0 = \frac{1}{2}m\ell^2\omega_{\vartheta,f}.$$

Section 11.5: Angular momentum

Example 11.7 Dumbbell collision (cont.)

3 EXECUTE PLAN Because the system is isolated, its angular momentum doesn't change, so

$$\begin{aligned}\Delta L_g &= \Delta L_{Ag} = \Delta L_{dg} \\ &= (\ell/2)m(v_{x,f} - v_{x,i}) + \frac{1}{2}m\ell^2\omega_{g,f} = 0\end{aligned}$$

or

$$v_{x,i} = v_{x,f} + \ell\omega_{g,f}. \quad (3)$$

Section 11.5: Angular momentum

Example 11.7 Dumbbell collision (cont.)

3 EXECUTE PLAN: we have

$$v_{x,i}^2 = v_{x,f}^2 + \frac{1}{2} \ell^2 \omega_{\vartheta,f}^2 \quad \text{and} \quad v_{x,i} = v_{x,f} + \ell \omega_{\vartheta,f}$$

solving:
$$\omega_{\vartheta,f} = \frac{4v_{x,i}}{3\ell} = +\frac{4v_i}{3\ell}. \quad \checkmark$$

and substituting this back,
$$v_{x,f} = -\frac{1}{3}v_{x,i} = -\frac{1}{3}v_i. \quad \checkmark$$

Section 11.5: Angular momentum

Example 11.7 Dumbbell collision (cont.)

④ EVALUATE RESULT The final rotational velocity is positive, indicating that the dumbbell in Figure 11.34 rotates counterclockwise, in agreement with my drawing. The x component of the final velocity of puck A is negative, indicating that it bounces back, as I expected.

Section 11.5

Question 6

If both the rotational inertia I and the rotational speed ω of an object are doubled, what happens to the object's rotational kinetic energy?

1. There is no change.
2. It is doubled.
3. It is quadrupled.
4. It increases by a factor of eight.
5. It is halved.
6. It decreases by a factor of four.
7. It decreases by a factor of eight.

Section 11.5

Question 6

If both the rotational inertia I and the rotational speed ω of an object are doubled, what happens to the object's rotational kinetic energy?

✓ It increases by a factor of eight

$$K = \frac{1}{2}I\omega^2$$

$$\text{Analogy: } K = p^2/2m \rightarrow L^2/2I = I^2\omega^2/2I = \frac{1}{2}I\omega^2$$

Section 11.6: Rotational inertia of extended objects

Section Goal

You will learn to

- Compute the rotational inertia for collections of particles and extended objects.

(b) . . . divide object into small segments of inertia δm and add up their rotational inertias.

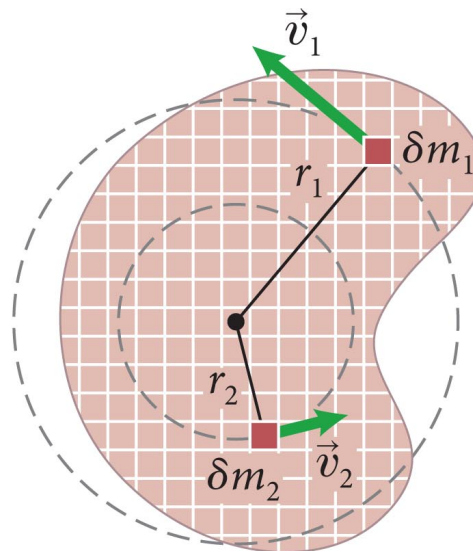

Section 11.6: Rotational Inertia of extended objects

- To apply the concepts of rotational inertia to extended objects as seen in the figure (part *a*), imagine breaking down the object to small segments (part *b*).
- The rotational kinetic energy of the object is the sum of the kinetic energies of these small elements:

$$K_{\text{rot}} = \frac{1}{2} \delta m_1 v_1^2 + \frac{1}{2} \delta m_2 v_2^2 + \dots = \sum_n \left(\frac{1}{2} \delta m_n v_n^2 \right)$$

- Using $v = r\omega$, we get

$$K_{\text{rot}} = \sum_n \left[\frac{1}{2} \delta m_n (\omega r_n)^2 \right] = \frac{1}{2} \left[\sum_n \delta m_n r_n^2 \right] \omega^2$$

(a) To determine rotational inertia of an extended object . . .

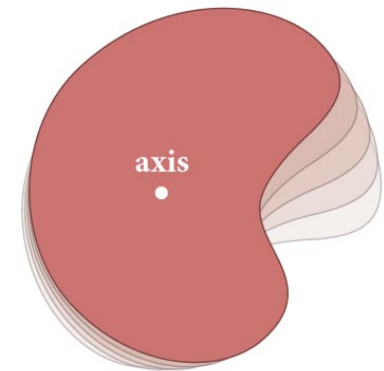

(b) . . . divide object into small segments of inertia δm and add up their rotational inertias.

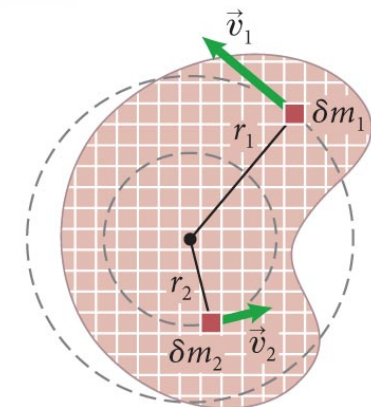

Section 11.6: Rotational Inertia of extended objects

- Using the definition of rotational inertia, we get

$$K_{\text{rot}} = \frac{1}{2} \left[\sum_n I_n \right] \omega^2 = \frac{1}{2} I \omega^2$$

- Therefore, the rotational inertia of the extended object is given by

$$I = \sum_n \delta m_n r_n^2$$



- In the limit $\delta m_n \rightarrow 0$, the sum becomes

$$I = \lim_{\delta m_n \rightarrow 0} \sum_n \delta m_n r_n^2 \equiv \int r^2 dm \quad (\text{extended object})$$

Section 11.6: Rotational Inertia of extended objects

Table 11.3 Rotational inertia of uniform objects of inertia M about axes through their center of mass

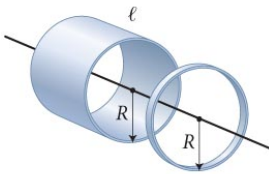
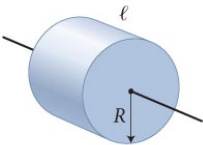
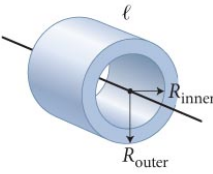
Rotation axes oriented so that object could roll on surface: For these axes, rotational inertia has the form cMR^2 , where $c = I/MR^2$ is called the *shape factor*. The farther the object's material from the rotation axis, the larger the shape factor and hence the rotational inertia.

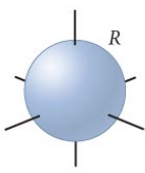
	thin-walled cylinder or hoop	solid cylinder	hollow-core cylinder	thin-walled hollow sphere	solid sphere
Shape					
Rotational inertia	MR^2	$\frac{1}{2}MR^2$	$\frac{1}{2}M(R_{\text{outer}}^2 + R_{\text{inner}}^2)$	$\frac{2}{3}MR^2$	$\frac{2}{5}MR^2$
Shape factor $c = I/MR^2$	1	$\frac{1}{2}$	$\frac{1}{2} \left[1 + \left(\frac{R_{\text{inner}}}{R_{\text{outer}}} \right)^2 \right]$	$\frac{2}{3}$	$\frac{2}{5}$

Other axis orientations

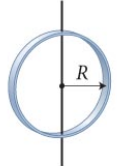
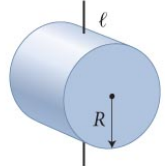
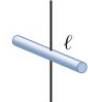
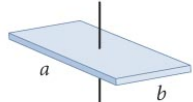
	thin-walled hoop	solid cylinder	thin rod	rectangular plate
Shape				
Rotational inertia	$\frac{1}{2}MR^2$	$\frac{1}{4}MR^2 + \frac{1}{12}M\ell^2$	$\frac{1}{12}M\ell^2$	$\frac{1}{12}M(a^2 + b^2)$

Section 11.6: Rotational inertia of extended objects

Example 11.8 Rotational inertia of a hoop about an axis through its center

Calculate the rotational inertia of a hoop of inertia m and radius R about an axis perpendicular to the plane of the hoop and passing through its center.

Section 11.6: Rotational inertia of extended objects

Example 11.8 Rotational inertia of a hoop about an axis through its center (cont.)

① GETTING STARTED I begin by drawing the hoop and a coordinate system (Figure 11.36). Because the axis goes through the center of the hoop, I let the origin be at that location. The axis of rotation is perpendicular to the plane of the drawing and passes through the origin.

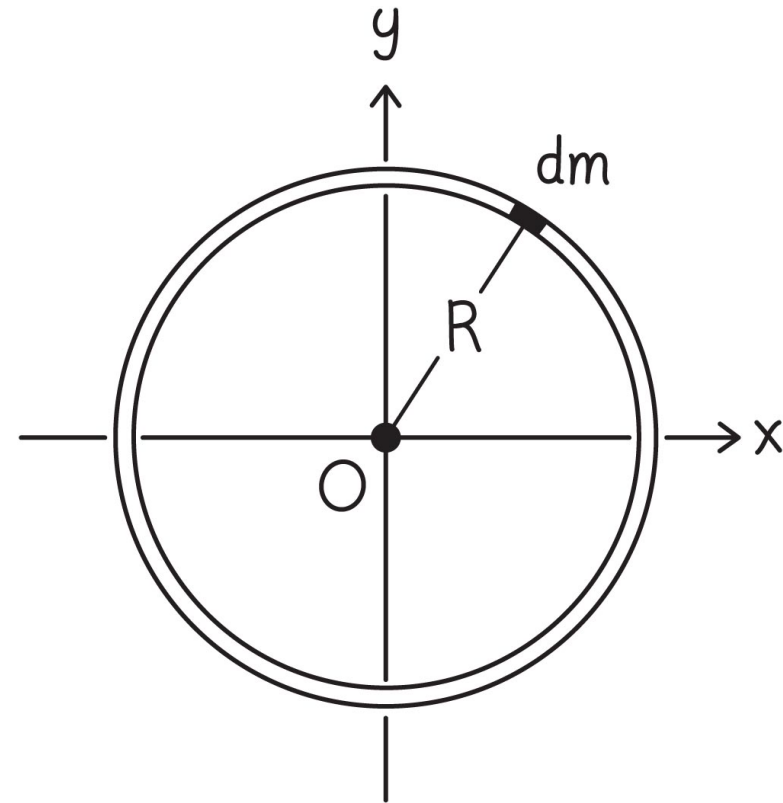

Section 11.6: Rotational inertia of extended objects

Example 11.8 Rotational inertia of a hoop about an axis through its center (cont.)

② DEVISE PLAN Equation 11.43 gives the rotational inertia of an object as the sum of the contributions from many small segments. If I divide the hoop into infinitesimally small segments each of inertia dm , I see that each segment lies the same distance $r = R$ from the rotation axis (one such segment is shown in Figure 11.36). This means I can pull the constant $r^2 = R^2$ out of the integral in Eq. 11.43, making it easy to calculate.

$$I = \lim_{\delta m_n \rightarrow 0} \sum_n \delta m_n r_n^2 \equiv \int r^2 dm \quad (\text{extended object})$$

Section 11.6: Rotational inertia of extended objects

Example 11.8 Rotational inertia of a hoop about an axis through its center (cont.)

③ EXECUTE PLAN Substituting $r = R$ in Eq. 11.43, I obtain

$$I = \int r^2 dm = R^2 \int dm = mR^2. \checkmark$$

Section 11.6: Rotational inertia of extended objects

Example 11.8 Rotational inertia of a hoop about an axis through its center (cont.)

④ EVALUATE RESULT This result makes sense because all the material contained in the hoop lies at the same distance R from the rotation axis. Therefore the rotational inertia of the hoop is the same as that of a particle of inertia m located a distance R from the rotation axis, which I know from Eq. 11.30: $I = mR^2$.

Section 11.6: Rotational inertia of extended objects

Example 11.9 Rotational inertia of a rod about an axis through its center

Calculate the rotational inertia of a uniform solid rod of inertia m and length ℓ about an axis perpendicular to the long axis of the rod and passing through its center.

Section 11.6: Rotational inertia of extended objects

Example 11.9 Rotational inertia of a rod about an axis through its center (cont.)

① GETTING STARTED I begin with a sketch of the rod. For this one-dimensional object, I choose an x axis that lies along the rod's long axis, and because the rotation being analyzed is about a rotation axis located through the rod's center, I choose this point for the origin of my x axis (Figure 11.37).

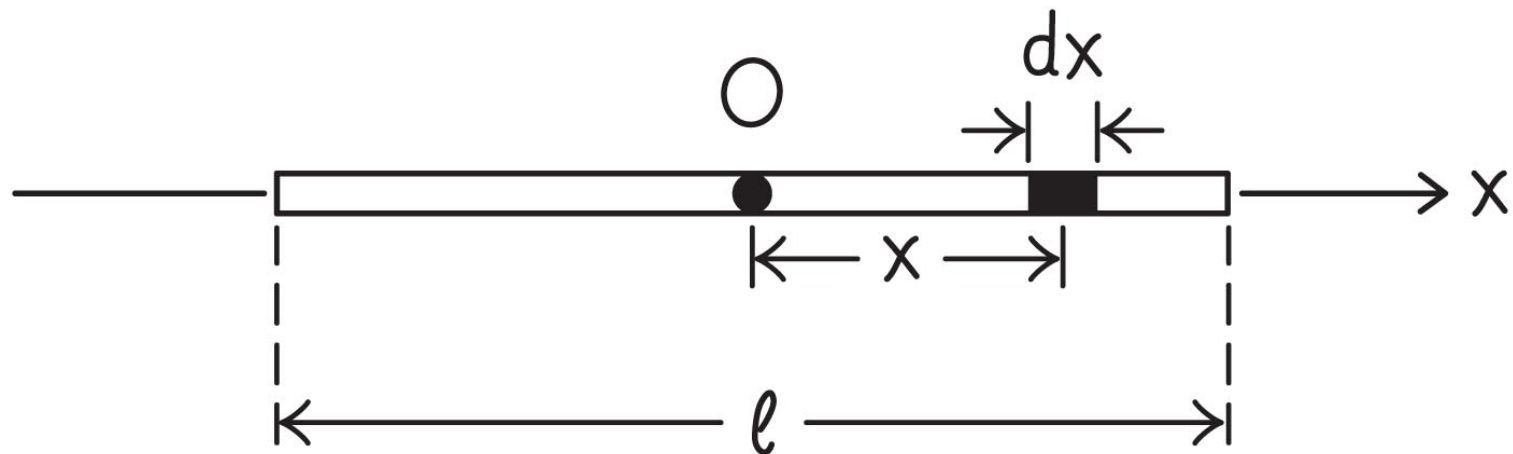

Section 11.6: Rotational inertia of extended objects

Example 11.9 Rotational inertia of a rod about an axis through its center (cont.)

② **DEVISE PLAN** Because the rod is a uniform one-dimensional object, I can use Eq. 11.44 to calculate its rotational inertia. First I determine the inertia per unit length λ . Then I carry out the integration from one end of the rod ($x = -\ell/2$) to the other ($x = +\ell/2$).

Section 11.6: Rotational inertia of extended objects

Example 11.9 Rotational inertia of a rod about an axis through its center (cont.)

3 EXECUTE PLAN The inertia per unit length is $\lambda = m/\ell$. That gives $dm = \lambda dx$. Substituting this expression and the integration boundaries into Eq. 11.44,

$$I = \lambda \int x^2 dx = \frac{m}{\ell} \int_{-\ell/2}^{+\ell/2} x^2 dx = \frac{m}{\ell} \left[\frac{x^3}{3} \right]_{-\ell/2}^{+\ell/2} = \frac{1}{12} m \ell^2. \quad \checkmark$$

Section 11.6: Rotational inertia of extended objects

Example 11.9 Rotational inertia of a rod about an axis through its center (cont.)

④ EVALUATE RESULT If I approximate each half of the rod as a particle located a distance $\ell/4$ from the origin I chose in Figure 11.37, the rotational inertia of the rod would be, from Eq. 11.30,

$$2 \left(\frac{1}{2} m \right) \left(\frac{1}{4} \ell \right)^2 = \frac{1}{16} m \ell^2$$

This is not too far from the value I obtained, so my answer appears to be reasonable.

Section 11.6: Rotational Inertia of extended objects

- Sometimes you need to know the moment of inertia about an axis through an unusual position (for an example, position P on the object shown in the figure).
- You can find it if you know the rotational inertia about a *parallel axis* through the center of mass:

$$I = I_{\text{cm}} + md^2$$

where d is the distance between the center of mass and the rotation axis

- This relationship is called the **parallel-axis theorem**.

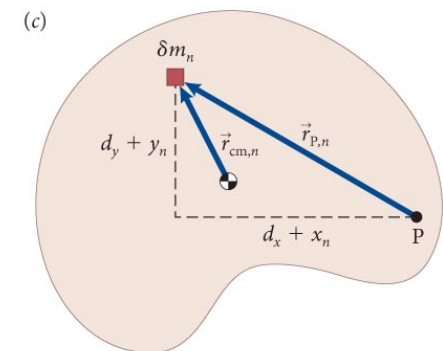
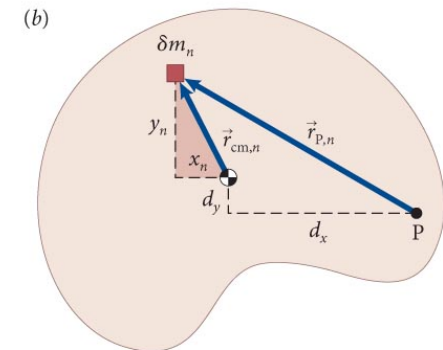
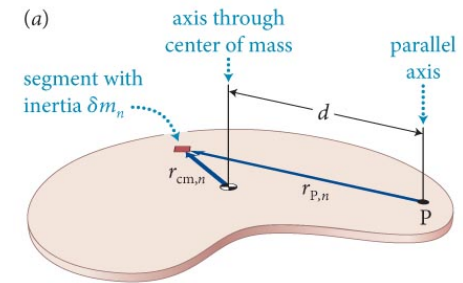

Section 11.6: Rotational inertia of extended objects

Example 11.11 Rotational inertia of a rod about an axis through one end

Use the parallel-axis theorem to calculate the rotational inertia of a uniform solid rod of inertia m and length ℓ about an axis perpendicular to the length of the rod and passing through one end.

Section 11.6: Rotational inertia of extended objects

Example 11.11 Rotational inertia of a rod about an axis through one end (cont.)

① GETTING STARTED I first make a sketch of the rod, showing its center of mass and the location of the rotational axis (Figure 11.41). Because I am told to use the parallel-axis theorem, I know I have to work with the rod's center of mass. I know that for a uniform rod, the center of mass coincides with the geometric center, and so I mark that location in my sketch.

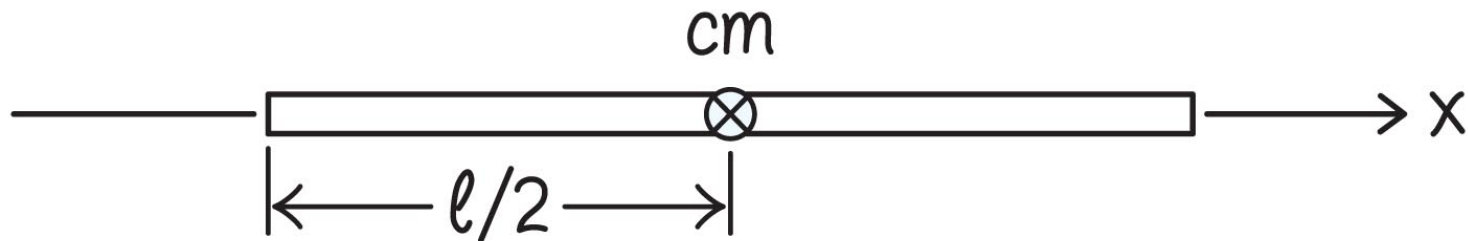

Section 11.6: Rotational inertia of extended objects

Example 11.11 Rotational inertia of a rod about an axis through one end (cont.)

② **DEVISE PLAN** In Example 11.9, I determined that the rotational inertia about an axis through the rod's center is $I = \frac{1}{12} m\ell^2$. For a uniform rod, the center of mass coincides with the geometric center, so I can use Eq. 11.53 to determine the rotational inertia about a parallel axis through one end.

Section 11.6: Rotational inertia of extended objects

Example 11.11 Rotational inertia of a rod about an axis through one end (cont.)

3 EXECUTE PLAN The distance between the rotation axis and the center of mass is $d = \frac{1}{2}\ell$, and so, with $I_{\text{cm}} = \frac{1}{12}m\ell^2$ from Example 11.9, Eq. 11.53 yields

$$I = I_{\text{cm}} + md^2 = \frac{1}{12}m\ell^2 + m\left(\frac{\ell}{2}\right)^2 = \frac{1}{3}m\ell^2. \checkmark$$

Section 11.6: Rotational inertia of extended objects

Example 11.11 Rotational inertia of a rod about an axis through one end (cont.)

④ EVALUATE RESULT I obtained the same answer in Checkpoint 11.10 by directly working out the integral.