

PRINCIPLES & PRACTICE OF  
PHYSICS

**Chapter 15**  
**Periodic Motion**

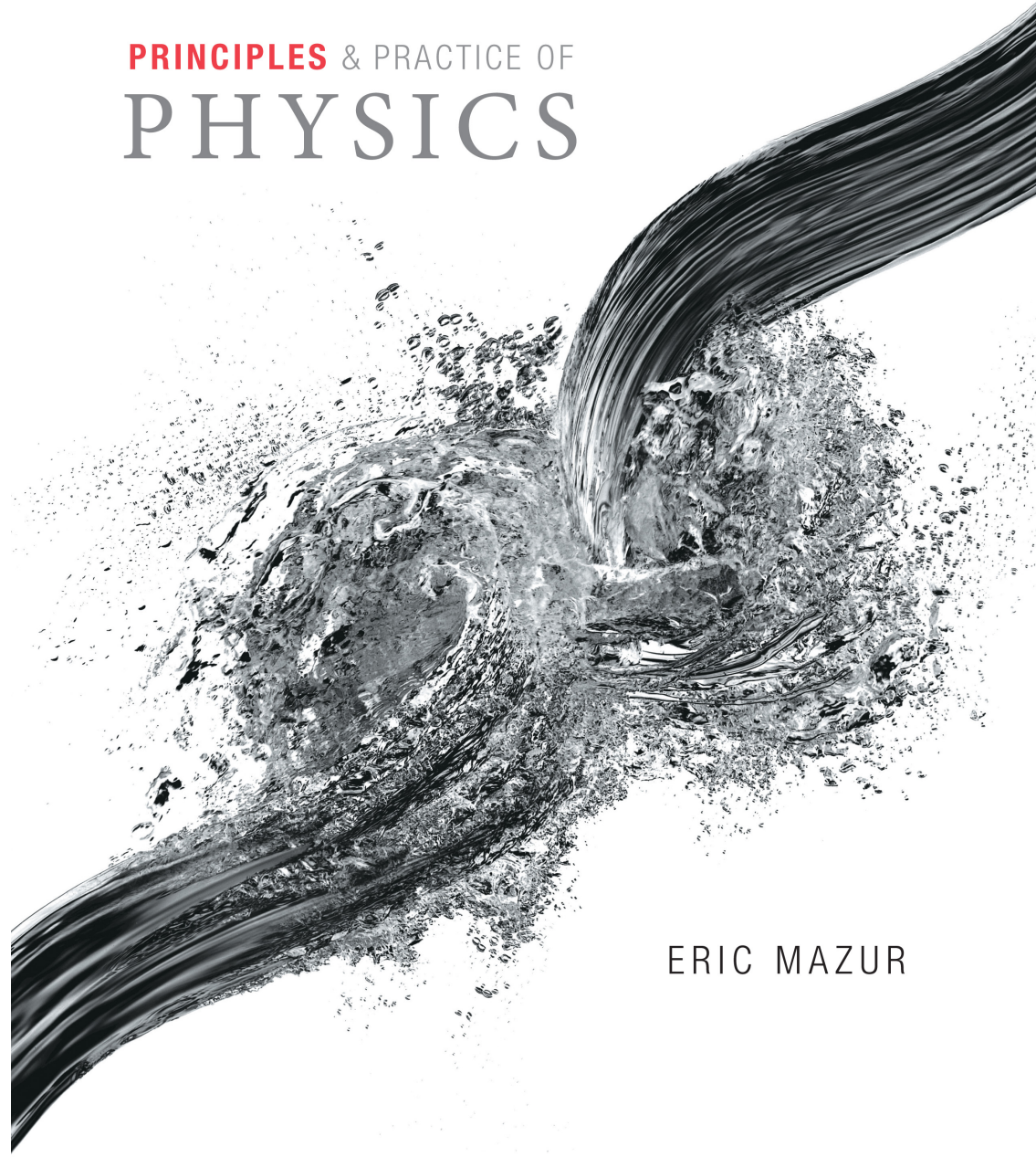

ERIC MAZUR

# Chapter 15 Periodic Motion

## Concepts

# Section 15.1: Periodic motion and energy

## Section Goals

You will learn to

- Define the concepts of **periodic motion, vibration, and oscillation**.
- Establish that in a closed system, periodic motion is characterized by the **continuous conversion** between potential energy and kinetic energy.

# Section 15.1: Periodic motion and energy

- Any motion that repeats itself at regular time intervals is called **periodic motion**.
- The figure shows the periodic motion of a spring-cart system.
- What forces are present during the oscillation?
- What must be true for the system to oscillate?

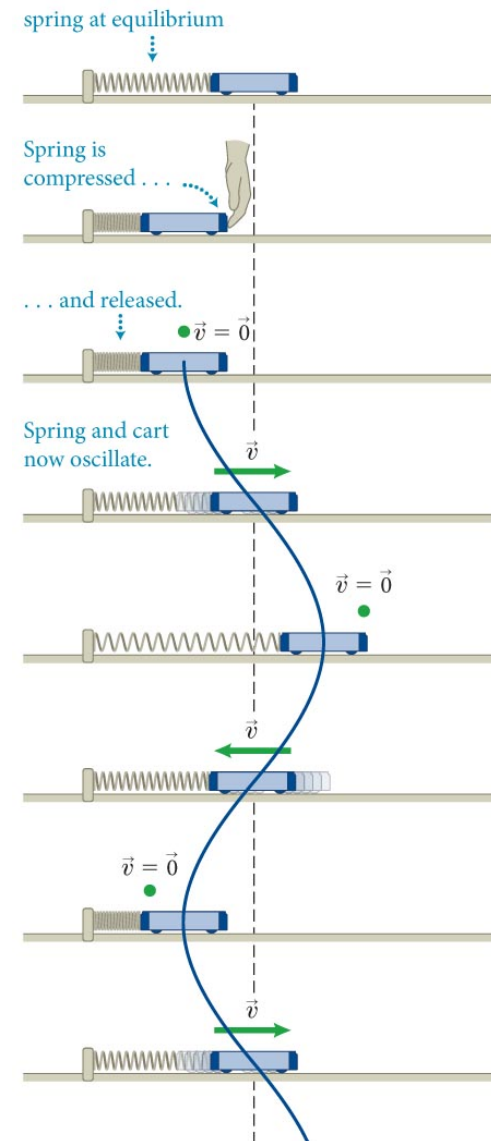

# Section 15.1: Periodic motion and energy

- The time interval it takes to complete a full cycle of the motion is the **period**  $T$ .
- The inverse of the period is called the **frequency**.

$$f = 1/T$$

- The object's maximum displacement from the equilibrium position is called the **amplitude**  $A$ .

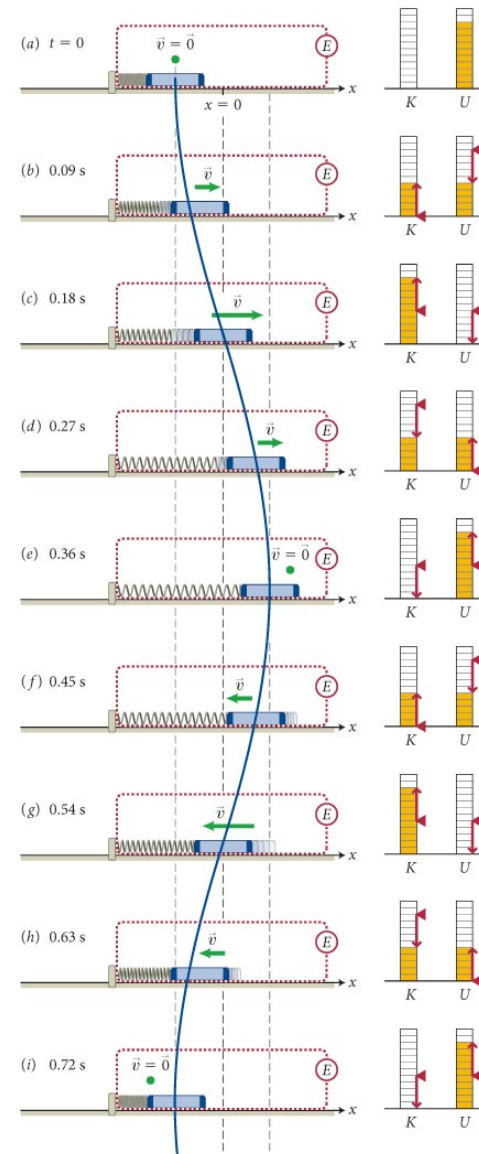

# Section 15.1: Periodic motion and energy

- In practice, periodic motion in mechanical systems will die out due to energy dissipation.
- If we ignore these *damping* effects, we find that
  - **Periodic motion is characterized by a continuous conversion between potential and kinetic energy in a closed system.**

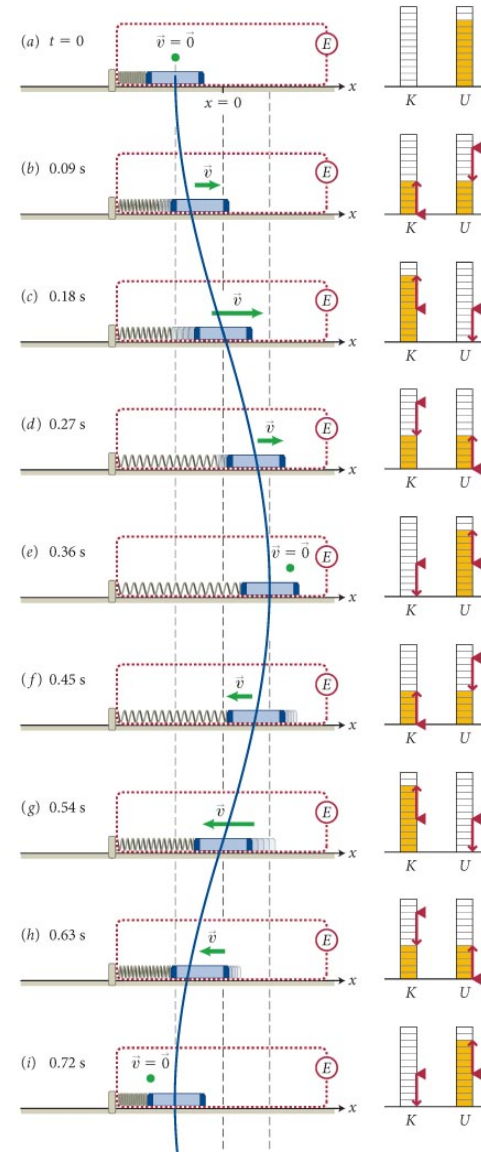

# Section 15.1: Periodic motion and energy

- The figure shows examples of oscillating systems.

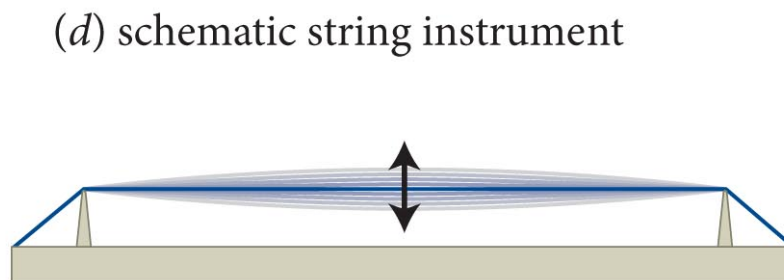
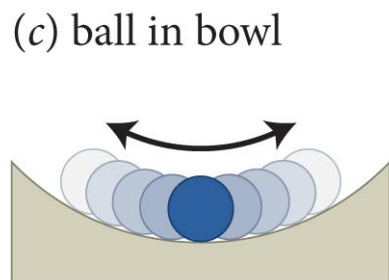
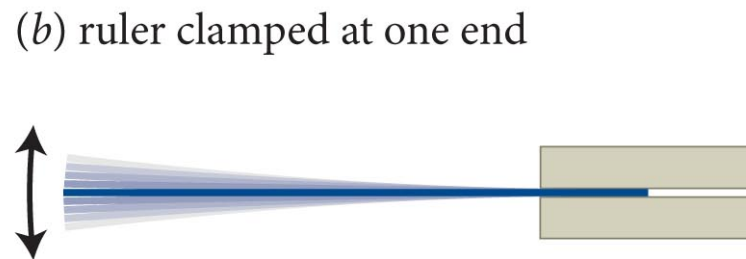
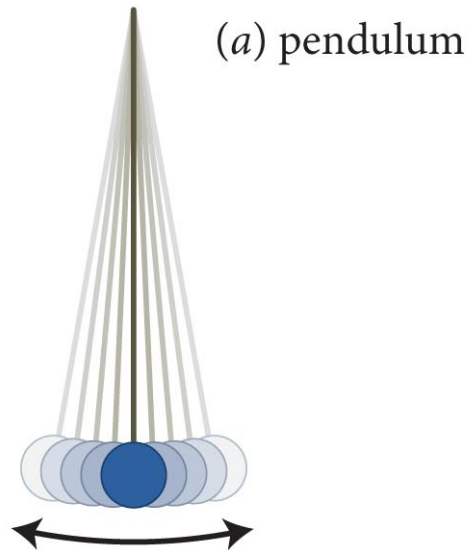



# Checkpoint 15.3

 **15.3** For each system in Figure 15.3, identify (a) the restoring force and (b) the type of potential energy associated with the motion.

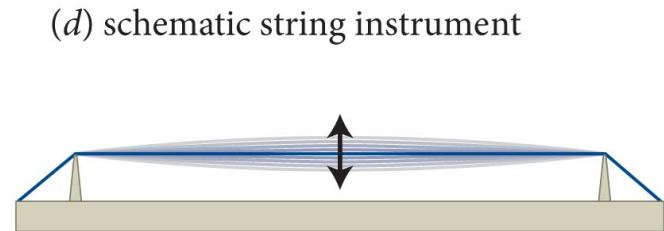
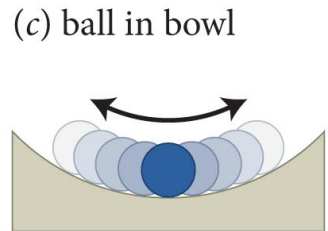
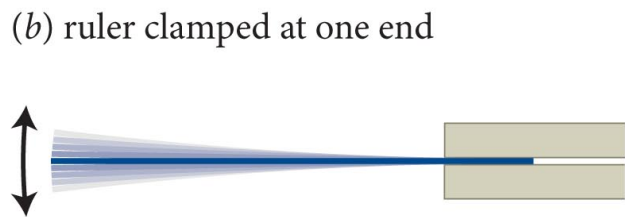
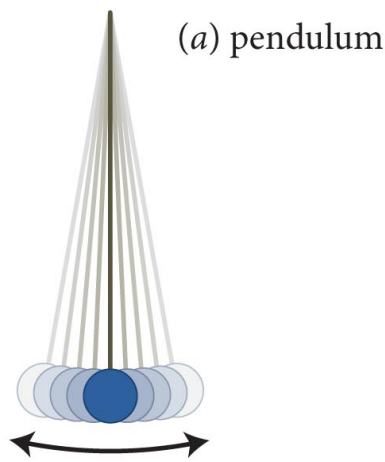



# Checkpoint 15.3



- (a) Tangential portion of gravitational force; gravitational potential
- (b) Vertical component of elastic force in the ruler; elastic potential
- (c) Tangential component of gravitational force; gravitational potential
- (d) Vertical component of elastic force in string; elastic potential

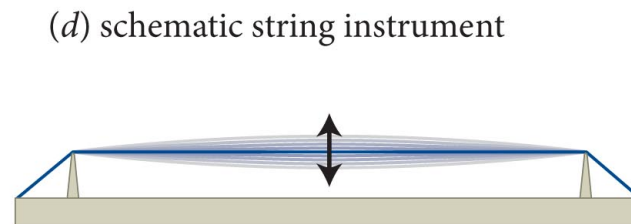
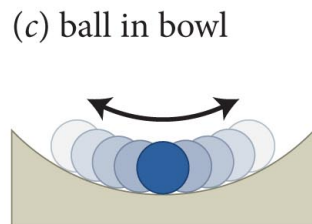
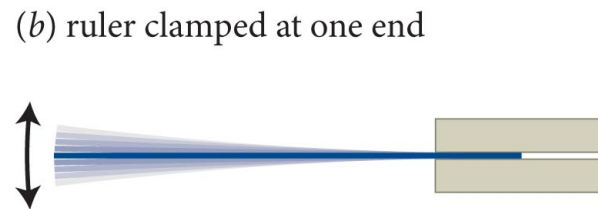
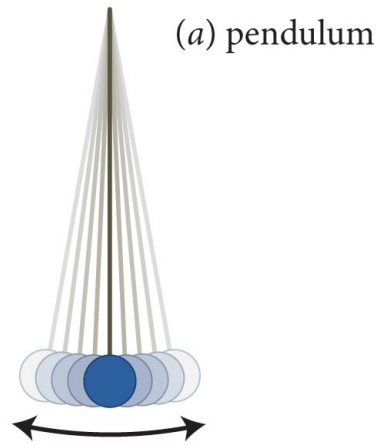

# Section 15.1

## Question 1

An object hangs motionless from a spring. **When the object is pulled down**, the sum of the elastic potential energy of the spring and the gravitational potential energy of the object and Earth

1. increases.
2. stays the same.
3. decreases.

# Section 15.1

## Question 1

An object hangs motionless from a spring. When the object is pulled down, the sum of the elastic potential energy of the spring and the gravitational potential energy of the object and Earth

- ✓ 1. increases:  $U^G$  decreases as  $x$ , but  $U^S$  increases as  $x^2$
- 2. stays the same.
- 3. decreases.

Increased energy comes from work done in pulling object down!

# Section 15.2: Simple harmonic motion

## Section Goals

You will learn to

- Define simple harmonic motion and represent it graphically.
- Understand the physical characteristics of the **restoring force** that is responsible for simple harmonic motions.

# Section 15.2: Simple harmonic motion

- Investigation of oscillating systems reveal that, when the amplitude is not too large, the period is independent of the amplitude.
- An oscillating system that exhibits this property is called *isochronous*.

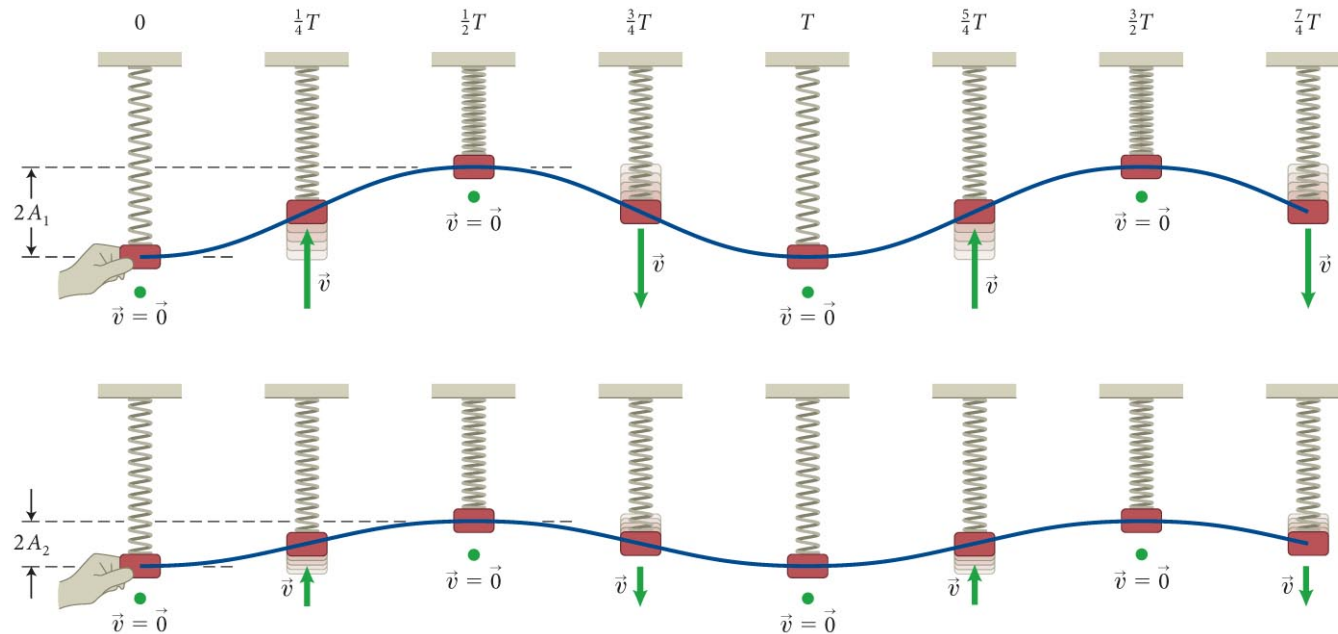

# Section 15.2: Simple harmonic motion

- The  $x(t)$  curve of an isochronous oscillation are sinusoidal.
- Periodic motion that yields a sinusoidal  $x(t)$  curve is called a **simple harmonic motion (SHM)**:
  - **A object executing simple harmonic motion is subject to a linear restoring force that tends to return the object to its equilibrium position and is linearly proportional to the object's displacement from its equilibrium position.**

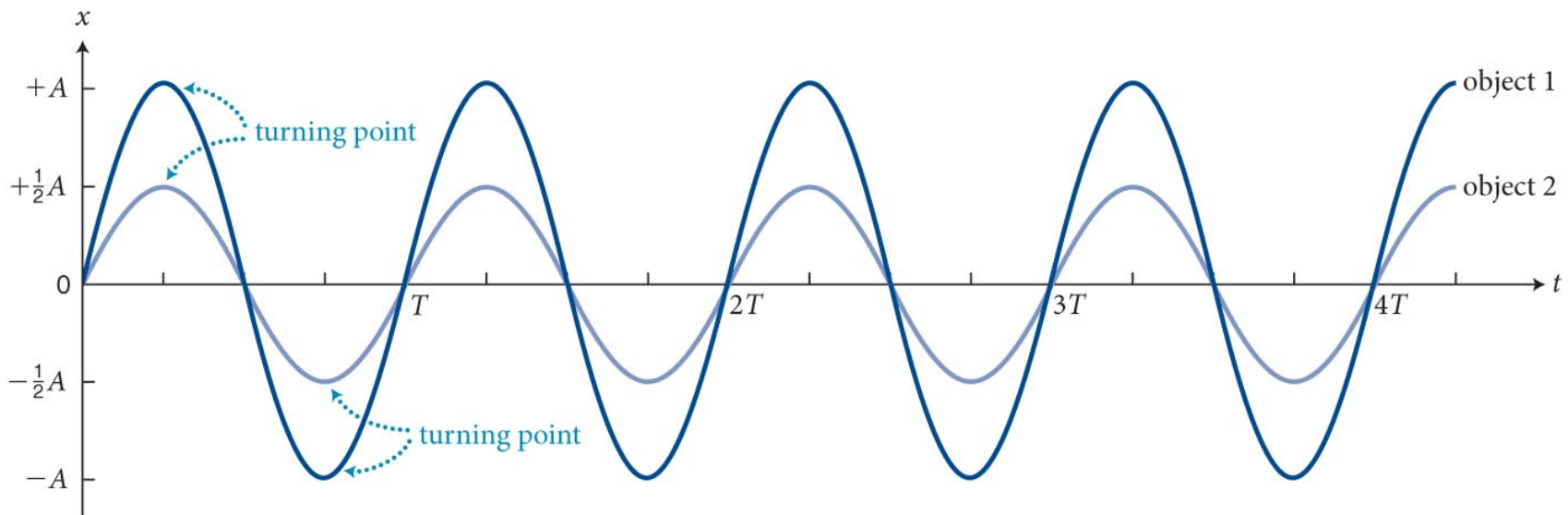

# Section 15.2: Simple harmonic motion

- Simple harmonic motion is closely related to circular motion.
  - The figure shows the shadow of a ball projected onto a screen.
  - As the ball moves in circular motion with constant rotational speed  $\omega$ , the shadow moves with simple harmonic motion.
  - The ball sweeps out at an angle  $\phi = \omega t$  in time  $t$ .
  - Then the position of the ball's shadow is described by  $A \sin(\omega t)$ , where  $A$  is the radius of the circle.

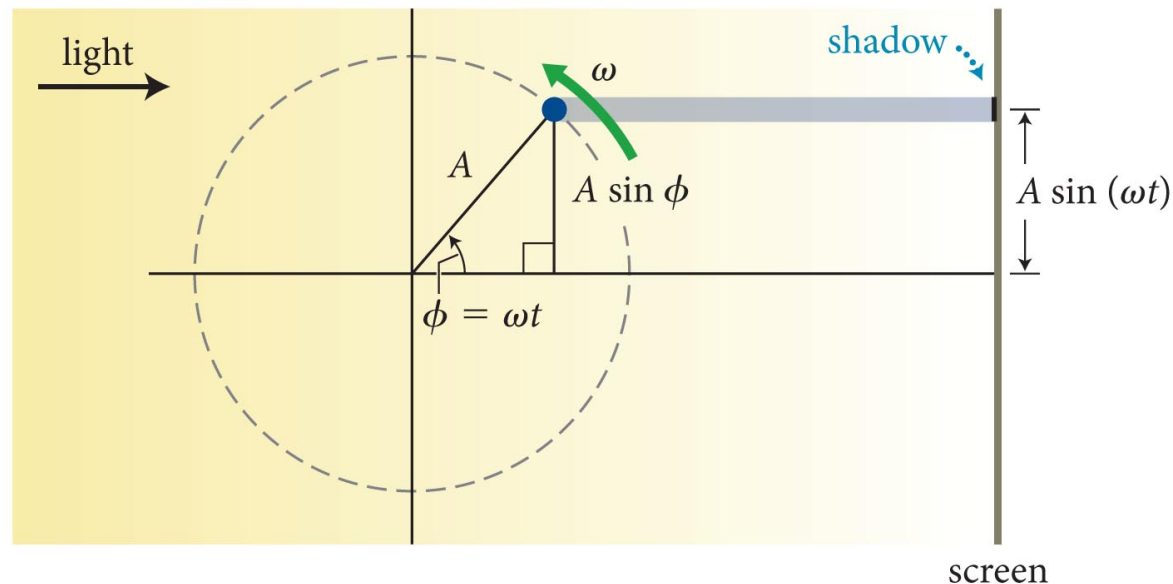



# Section 15.2: Simple harmonic motion

- As illustrated in the figure, the correspondence between circular motion and simple harmonic motion can be demonstrated experimentally.

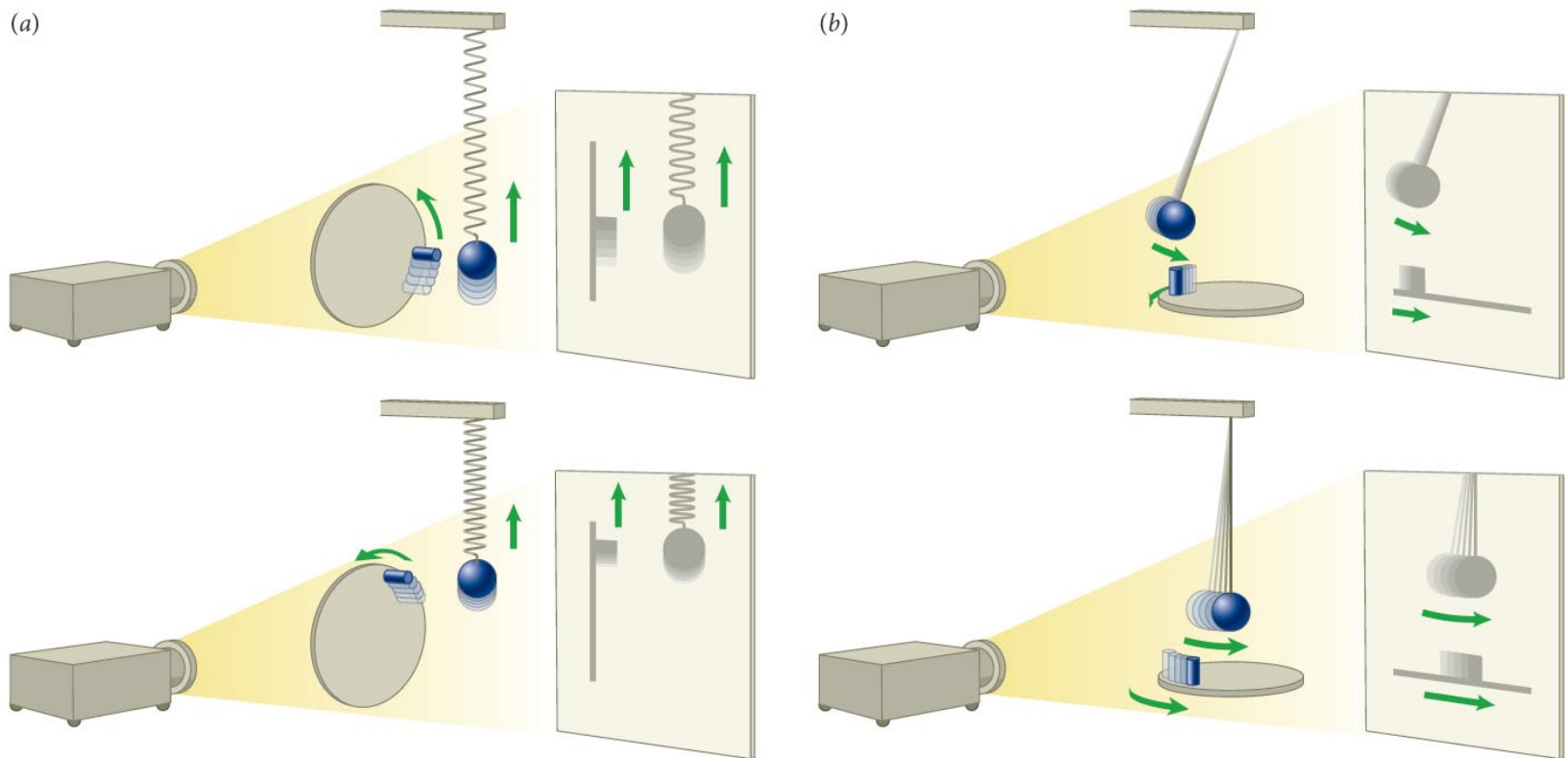

# Section 15.2

## Question 2

A mass attached to a spring oscillates back and forth as indicated in the position vs. time plot below. At point  $P$ , the mass has

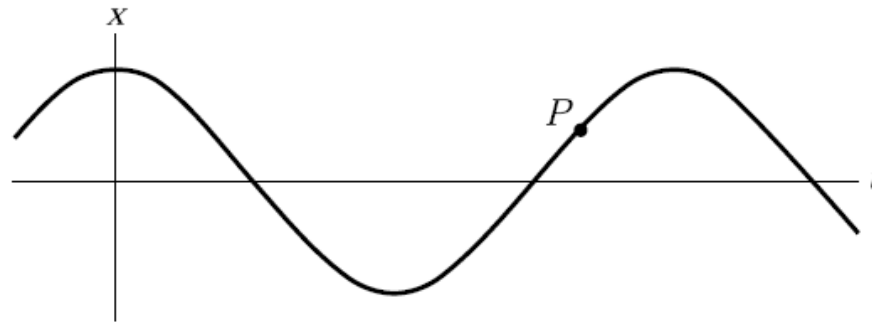

1. positive velocity and positive acceleration.
2. positive velocity and negative acceleration.
3. positive velocity and zero acceleration.
4. negative velocity and positive acceleration.
5. negative velocity and negative acceleration.
6. negative velocity and zero acceleration.
7. zero velocity but is accelerating (positively or negatively).

# Section 15.2

## Question 2

A mass attached to a spring oscillates back and forth as indicated in the position vs. time plot below. At point  $P$ , the mass has

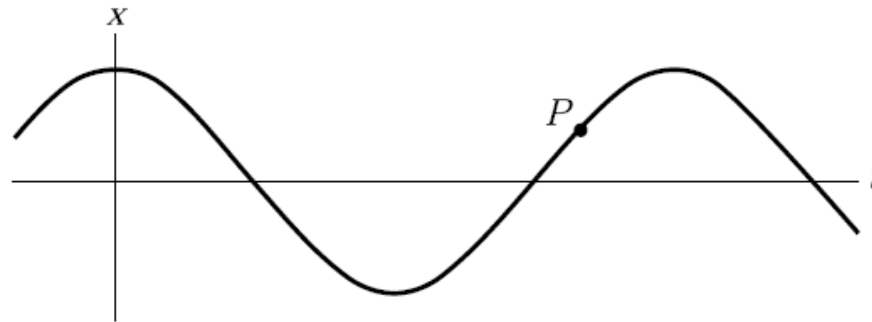

1. positive velocity and positive acceleration.
- ✓ 2. positive velocity and negative acceleration.
3. positive velocity and zero acceleration.
4. negative velocity and positive acceleration.
5. negative velocity and negative acceleration.
6. negative velocity and zero acceleration.
7. zero velocity but is accelerating (positively or negatively).

# Section 15.4: Restoring forces in simple harmonic motion

## Section Goals

You will learn to

- Correlate the **restoring force** and the resulting motion of a simple harmonic oscillator.
- Relate the period of simple harmonic oscillations to the magnitude of the restoring force.
- Establish that the period of a simple pendulum is independent of the mass of the pendulum.

# Section 15.4: Restoring forces in simple harmonic motion

- Periodic motion requires a restoring force that tends to return the object to the equilibrium position.
- A consequence of the restoring force about a stable equilibrium position is
  - **In the absence of friction, a small displacement of a system from a position of stable equilibrium causes the system to oscillate.**

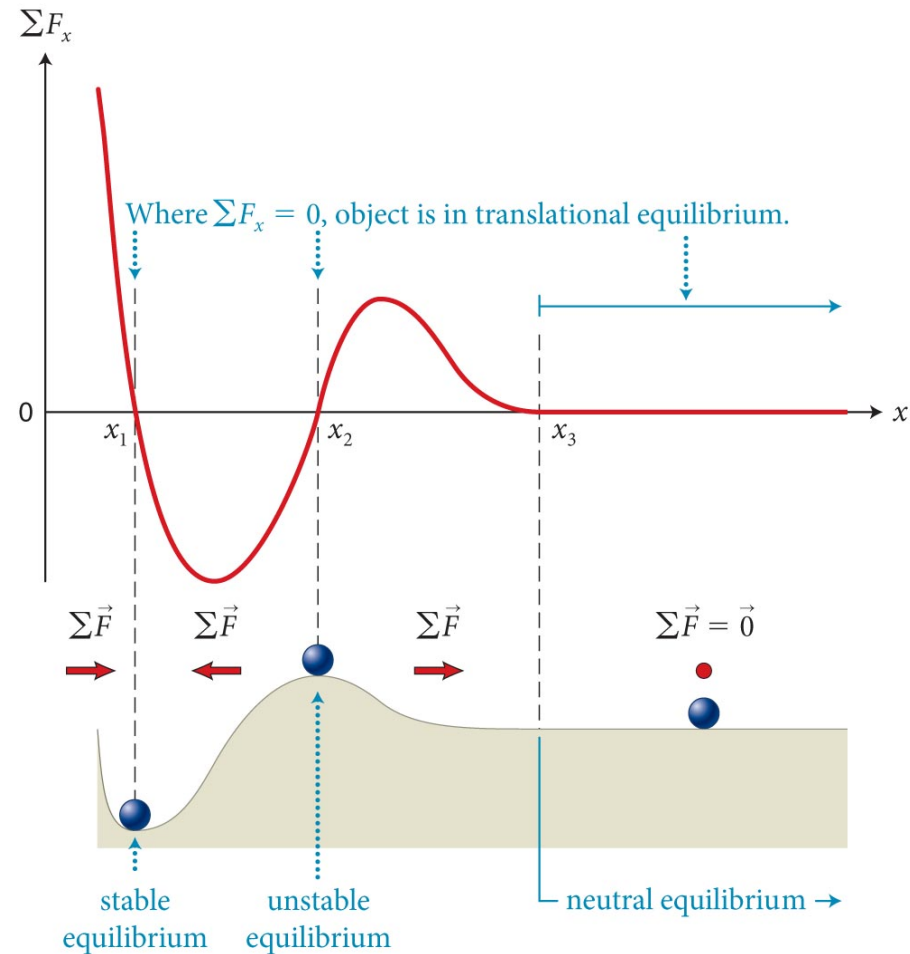

# Section 15.4: Restoring forces in simple harmonic motion

- As illustrated in the figure:
  - **For sufficiently small displacements away from the equilibrium position  $x_0$ , restoring forces are always linearly proportional to the displacement.**
  - **Consequently, for small displacements, objects execute simple harmonic motion about a stable equilibrium position.**

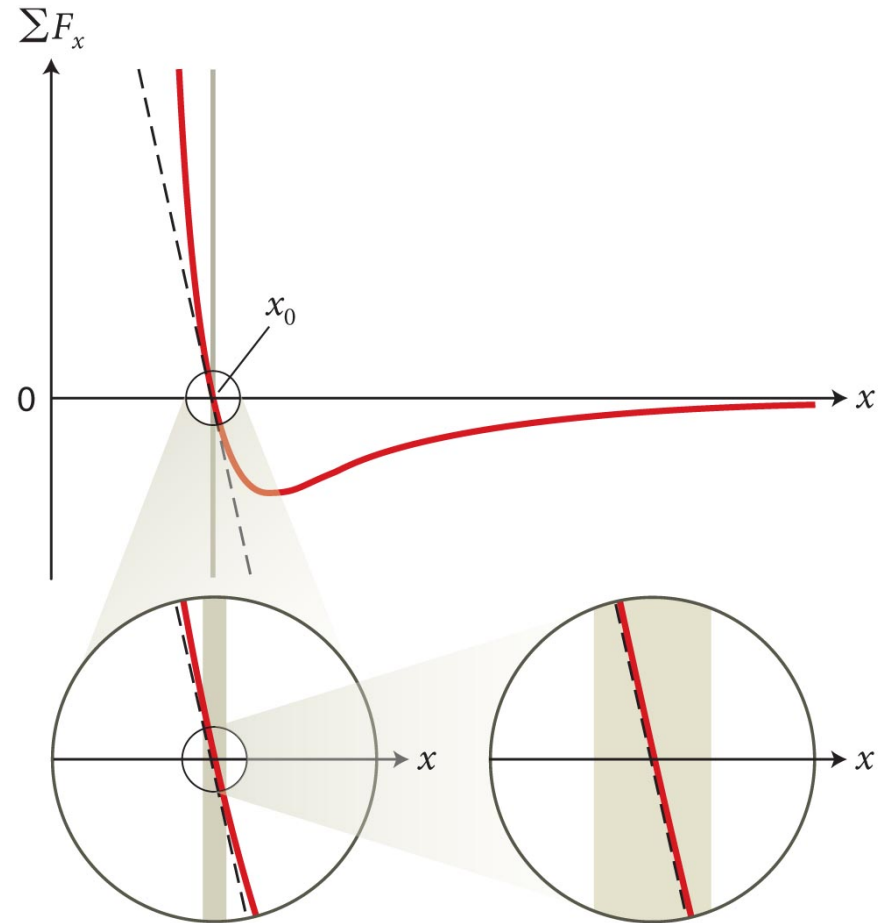

# Section 15.4: Restoring forces in simple harmonic motion

- The figure illustrates the cause for the restoring force for a taut string displaced from its equilibrium position.

(a) When string is displaced from equilibrium position . . .

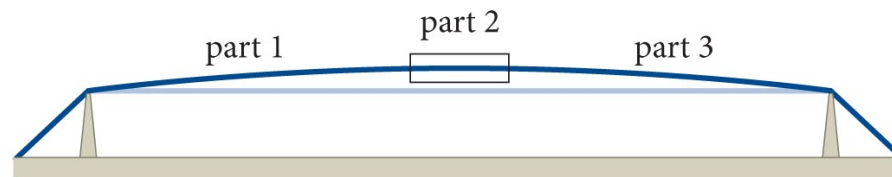

(b) . . . parts 1 and 3 exert forces on part 2.

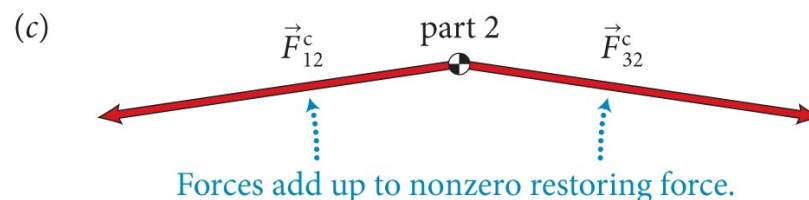
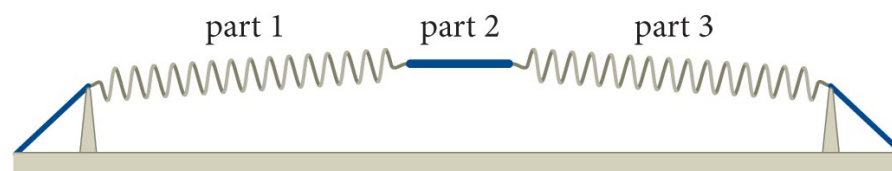



# Section 15.4: Restoring forces in simple harmonic motion

- The restoring force for a simple pendulum is provided by the component of the gravitational force perpendicular to the string.
- From the free-body diagram we can see that the magnitude of the restoring force on the bob is

$$mg \sin \theta = (mg)(x/\ell) = (mg/\ell)x$$

(a) Pendulum displaced from equilibrium

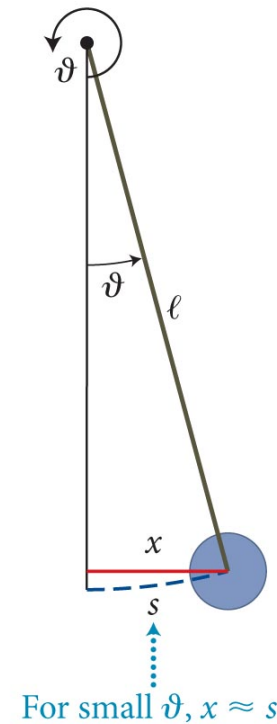

(b) Free-body diagram for bob

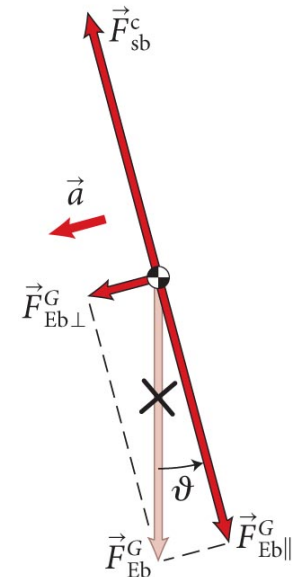

# Section 15.4: Restoring forces in simple harmonic motion

## Example 15.1 Displaced string

Show that for small displacements the restoring force exerted on part 2 of the displaced string in Figure 15.14 is linearly proportional to the displacement of that part from its equilibrium position.

(a) When string is displaced from equilibrium position . . .

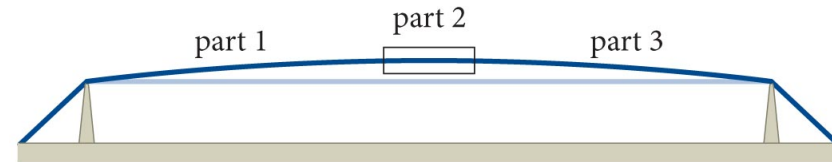

(b) . . . parts 1 and 3 exert forces on part 2.

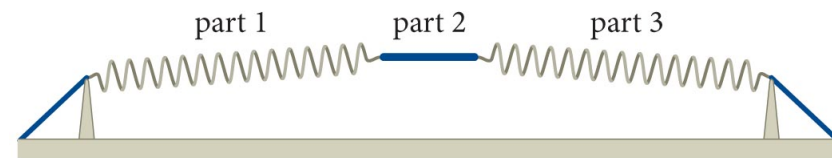

(c)

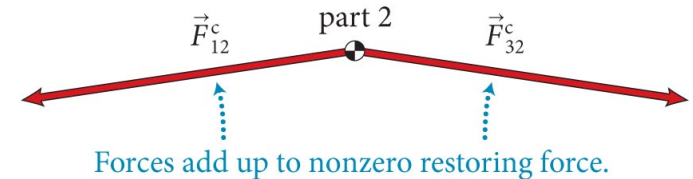

# Section 15.4: Restoring forces in simple harmonic motion

## Example 15.1 Displaced string (cont.)

**1** GETTING STARTED Figure 15.14c shows the forces exerted by parts 1 and 3 on part 2 when the string is displaced from its equilibrium position. I'll assume that these forces are much greater than the force of gravity exerted on part 2 so that I can ignore gravity in this problem. The force that pulls the string away from the equilibrium position is not shown, which means the string has been released after being pulled away from the equilibrium position.

(a) When string is displaced from equilibrium position . . .

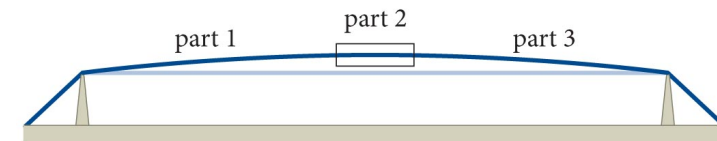

(b) . . . parts 1 and 3 exert forces on part 2.

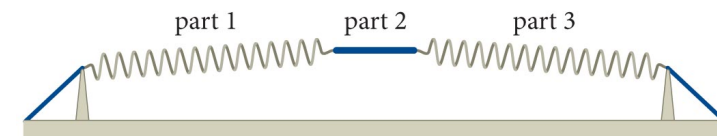

(c)

Forces add up to nonzero restoring force.

A diagram showing a red line representing part 2 of the string, which is curved downwards. Two red arrows point outwards from the center of part 2, labeled  $\vec{F}_{12}^c$  and  $\vec{F}_{32}^c$ . Two blue dashed arrows point upwards from the center of part 2, indicating the net restoring force.

# Section 15.4: Restoring forces in simple harmonic motion

## Example 15.1 Displaced string (cont.)

① GETTING STARTED I begin by making a free-body diagram and choosing a set of axes (Figure 15.17). The  $x$  components of the forces  $\vec{F}_{12}^c$  and  $\vec{F}_{32}^c$  cancel; the sum of the  $y$  components is the restoring force. The magnitude of the  $y$  components is determined by the angle  $\theta$  between the  $x$  axis and either  $\vec{F}_{12}^c$  or  $\vec{F}_{32}^c$ .

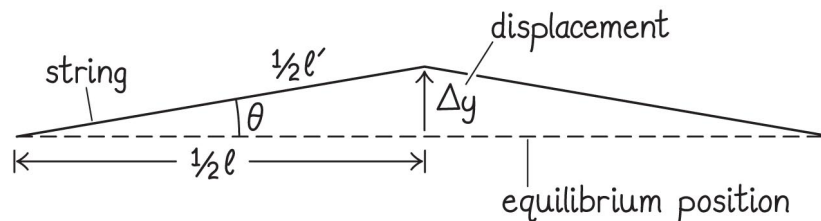
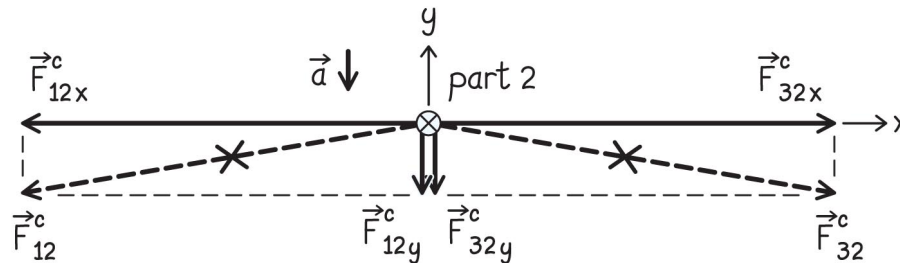

# Section 15.4: Restoring forces in simple harmonic motion

## Example 15.1 Displaced string (cont.)

**1** GETTING STARTED I also make a sketch of the displaced string, showing the displacement  $\Delta y$  of part 2 from its equilibrium position. I denote the length of the string in its equilibrium position by  $\ell$  and the length of the displaced string by  $\ell'$ .

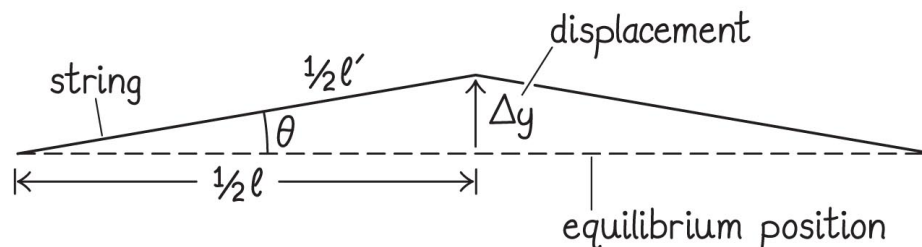
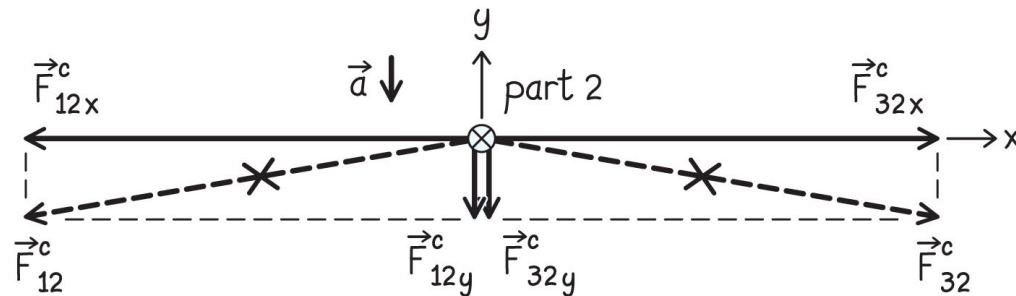

# Section 15.4: Restoring forces in simple harmonic motion

## Example 15.1 Displaced string (cont.)

② DEVISE PLAN The forces  $\vec{F}_{12}^c$  and  $\vec{F}_{32}^c$  are equal in magnitude and their  $y$  components are determined by  $\sin \theta$ , which is equal to  $\Delta y / (\frac{1}{2} \ell')$ . If the displacement is small, I can assume that the length of the string doesn't change much from its equilibrium value, so that  $\ell \approx \ell'$ .

Because the forces  $\vec{F}_{12}^c$  and  $\vec{F}_{32}^c$  are proportional to the tension in the string, I can also consider these forces to be constant. Using this information, I can express the restoring force in terms of the displacement  $\Delta y$ .

# Section 15.4: Restoring forces in simple harmonic motion

## Example 15.1 Displaced string (cont.)

③ EXECUTE PLAN From my sketch I see that the restoring force is  $F_{12y}^c + F_{32y}^c$ . Because  $\vec{F}_{12}^c$  and  $\vec{F}_{32}^c$  are equal in magnitude, I can write the sum of the  $y$  components as  $2F_{12y}^c = 2F_{12}^c \sin\theta$ . I also know that  $\sin\theta = \Delta y / (\frac{1}{2}\ell') \approx \Delta y / (\frac{1}{2}\ell)$ .

Combining these two relationships, I obtain for the restoring force:  $F_{\text{restoring}} = 2F_{12y}^c \approx (4F_{12}^c / \ell)\Delta y$ . For small displacements, the term in parentheses is constant and so the restoring force is, indeed, proportional to the displacement  $\Delta y$ . ✓



# Section 15.4: Restoring forces in simple harmonic motion

## Example 15.1 Displaced string (cont.)

④ EVALUATE RESULT I made two assumptions to derive my answer.

- The first is that gravity can be ignored. Indeed, taut strings tend to be straight, indicating that gravity (which would make the strings sag) doesn't play an appreciable role.
- The second was that the length of the string doesn't change much when it is displaced from equilibrium. This assumption is also justified because the displacement of a string tends to be several orders of magnitude smaller than the string length.

# Section 15.4: Restoring forces in simple harmonic motion

- Another way to look at oscillations is to say
  - **Oscillations arise from interplay between inertia and a restoring force.**
- Using this interplay between inertia and a restoring force we could predict that
  - **The period of an oscillating object increases when its mass is increased and decreases when the magnitude of the restoring force is increased.**
- However, this relation does not hold for pendulums:
  - **The period of a pendulum is independent of the mass of the pendulum.**

# Section 15.4

## Question 4

A child and an adult are on adjacent swings at the playground. Is the adult able to swing in synchrony with the child?

1. No, this is impossible because the inertia of the two are different.
2. Yes, as long as the lengths of the two swings are adjusted.
3. Yes, as long as the lengths of the swings are the same.

# Section 15.4

## Question 4

A child and an adult are on adjacent swings at the playground. Is the adult able to swing in synchrony with the child?

1. No, this is impossible because the inertia of the two are different.
2. Yes, as long as the lengths of the two swings are adjusted.
- ✓ 3. Yes, as long as the lengths of the swings are the same.

# Chapter 15: Periodic Motion

## Quantitative Tools

# Section 15.5: Energy of a simple harmonic oscillator

## Section Goals

You will learn to

- Represent the motion of a simple harmonic oscillator using the **reference circle** and **phasor** diagrams.
- Derive the **kinematic, dynamic, and energy relationships** for simple harmonic oscillators mathematically.

# Section 15.5: Energy of a simple harmonic oscillator

- A **phasor** is a rotating arrow whose tip traces a circle called the **reference circle**.
- As the phasor rotates counterclockwise at a constant rotational speed  $\omega$ , its vertical component varies sinusoidally and therefore describe a simple harmonic motion.

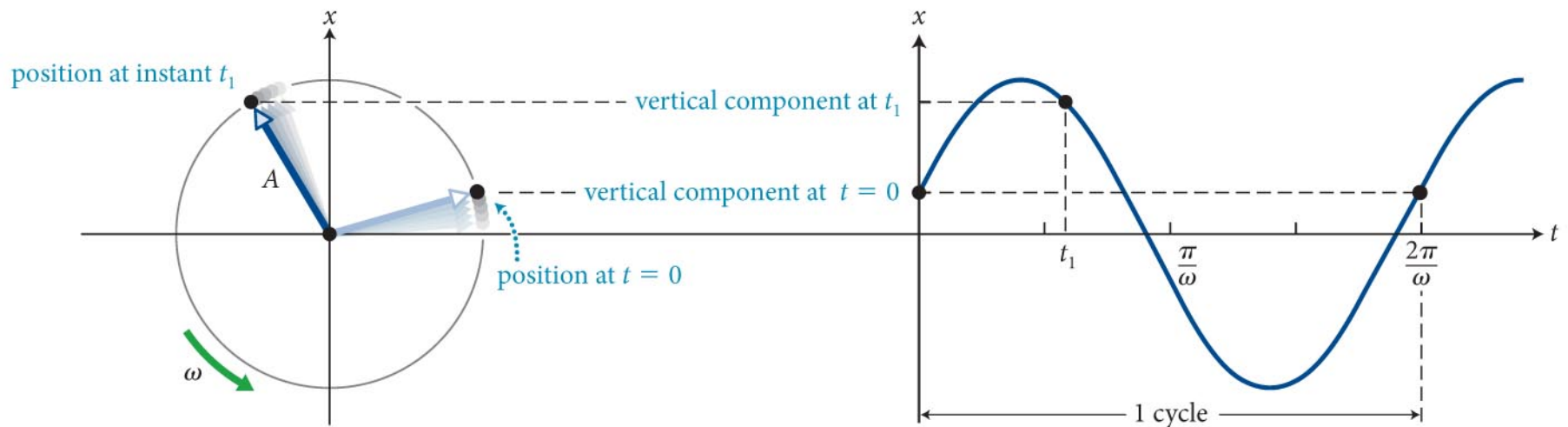



# Section 15.5: Energy of a simple harmonic oscillator

- If the phasor completes one revolution in a period  $T$ , then

$$\omega \equiv \frac{\Delta\vartheta}{\Delta t} = \frac{2\pi}{T}$$

- And the frequency of the corresponding SHM is

$$f \equiv \frac{1}{T}$$

- The SI units of  $f$  are  $1 \text{ Hz} = 1 \text{ s}^{-1}$ .
- Combining the previous two equations we get

$$\omega = 2\pi f$$

- $\omega$  is often referred to as the **angular frequency** and has the same unit ( $\text{s}^{-1}$ ) as frequency (think: rad/sec)

# Section 15.5: Energy of a simple harmonic oscillator

- The rotational position of the tip of the phasor is called the **phase** of the motion and is given by  $\varphi(t) = \omega t + \varphi_i$ .
- Then, the vertical component of the phasor can be written as
$$x(t) = A \sin \varphi(t) = A \sin(\omega t + \varphi_i) \quad (\text{simple harmonic motion})$$
- $A$  is the amplitude of the phasor and  $\varphi_i$  is phase (angle) at  $t = 0$  s.
- Means there are **2 boundary conditions**: amplitude & initial phase

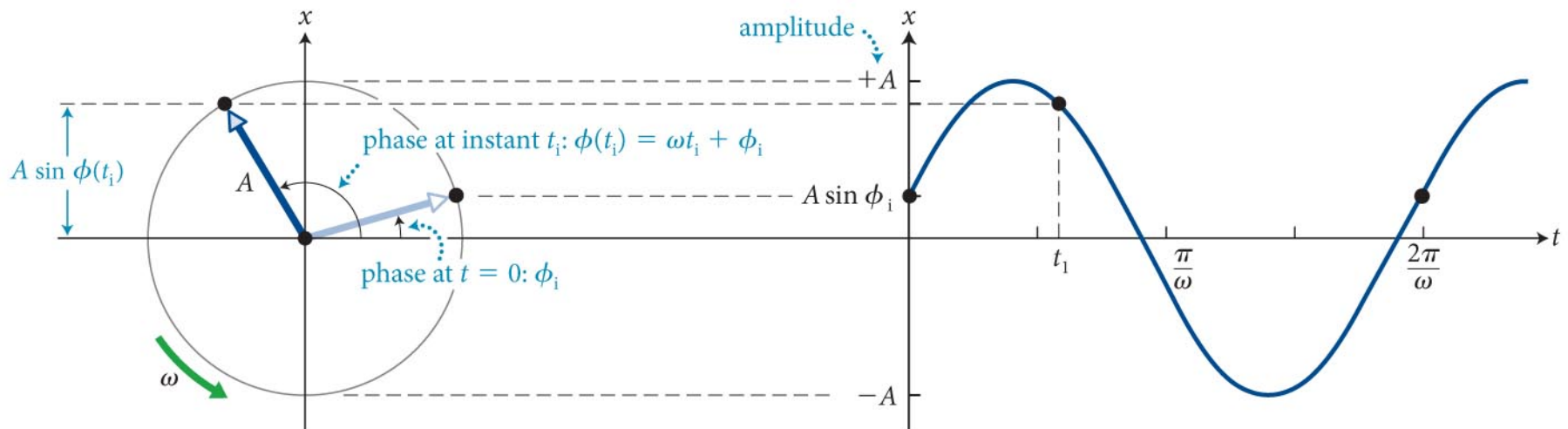

# Section 15.5: Energy of a simple harmonic oscillator

- Now, we can obtain the velocity and acceleration of the harmonic oscillator:

$$v_x \equiv \frac{dx}{dt} = \omega A \cos(\omega t + \phi_i) \quad (\text{simple harmonic motion})$$

$$a_x \equiv \frac{d^2x}{dt^2} = -\omega^2 A \sin(\omega t + \phi_i) \quad (\text{simple harmonic motion})$$

- Comparing equations for  $x(t)$  and  $a(t)$ , we can write

$$a_x = -\omega^2 x \quad (\text{simple harmonic motion})$$

- Using Newton's 2<sup>nd</sup> law,  $\Sigma F_x = ma_x$ , another constraint!

$$\Sigma F_x = -m\omega^2 x \quad (\text{simple harmonic motion})$$

# Section 15.5 Energy of a simple harmonic oscillator

- Whenever we can show  $\Sigma F_x = -m\omega^2x$ , we have simple harmonic motion with angular frequency  $\omega$
- Equivalently, we can show  $a_x = -\omega^2x$
- Doesn't matter what the forces are!
  
- If we can show the force balance is constrained in this way, we are *done*: the same equations have the same solutions!
  
- This also means: all simple harmonic oscillators are basically masses & springs

# Section 15.5: Energy of a simple harmonic oscillator

- The work done by the forces exerted on the harmonic oscillator as it moves from the equilibrium position toward the positive  $x$  direction is

$$W = \int_{x_0}^x \sum F_x(x) dx = - \int_{x_0}^x m\omega^2 x dx$$

- This work causes a change in kinetic energy, given by

$$\Delta K = -m\omega^2 \int_{x_0}^x x dx = -m\omega^2 \left[ \frac{1}{2} x^2 \right]_{x_0}^x = \frac{1}{2} m\omega^2 x^2 - \frac{1}{2} m\omega^2 x_0^2$$

- For a closed system  $\Delta E = \Delta K + \Delta U = 0$ , which gives us

$$\Delta U = U(x) - U(x_0) = \frac{1}{2} m\omega^2 x^2 - \frac{1}{2} m\omega^2 x_0^2$$

# Section 15.5: Energy of a simple harmonic oscillator

- If we let  $U(x_0) = 0$  (a free choice), then

$$E = K + U = \frac{1}{2}mv^2 + \frac{1}{2}m\omega^2x^2$$

- Using expressions for  $x(t)$  and  $v(t)$ , we get

$$\begin{aligned} E &= \frac{1}{2}m\omega^2 A^2 \cos^2(\omega t + \phi_i) + \frac{1}{2}m\omega^2 A^2 \sin^2(\omega t + \phi_i) \\ &= \frac{1}{2}m\omega^2 A^2 \quad (\text{simple harmonic motion}) \end{aligned}$$

- Total energy is constant, determined by amplitude and frequency

## Section 15.5

### Question 5

If you know the initial position of an oscillator, what else do you need to know in order to determine the initial phase of the oscillation? Answer all that apply.

1. The mass
2. The spring constant
3. The initial velocity
4. The angular frequency
5. The amplitude

# Section 15.5

## Question 5

If you know the initial position of an oscillator, what else do you need to know in order to determine the initial phase of the oscillation? Answer all that apply.

1. The mass
2. The spring constant
3. The initial velocity
4. The angular frequency
- ✓ 5. The amplitude

$$x(t) = A \sin \varphi(t) = A \sin(\omega t + \varphi_i)$$

If  $t = 0$ , need  $A$  to get  $\varphi_i$



# Section 15.6: Simple harmonic motion and springs

## Section Goal

You will learn to

- Apply the mathematical formalism of simple harmonic motion to the case of a **mass attached to a spring**.

# Section 15.6: Simple harmonic motion and springs

- Consider the spring-cart system shown. Let  $x_0 = 0$ .

- The force exerted by the spring on the cart is

$$F_{SCx}^C = -kx$$

- Using  $\Sigma F_x = ma_x$ , we can find the equation of motion for the car to be

$$\frac{d^2x}{dt^2} = -\frac{k}{m}x$$

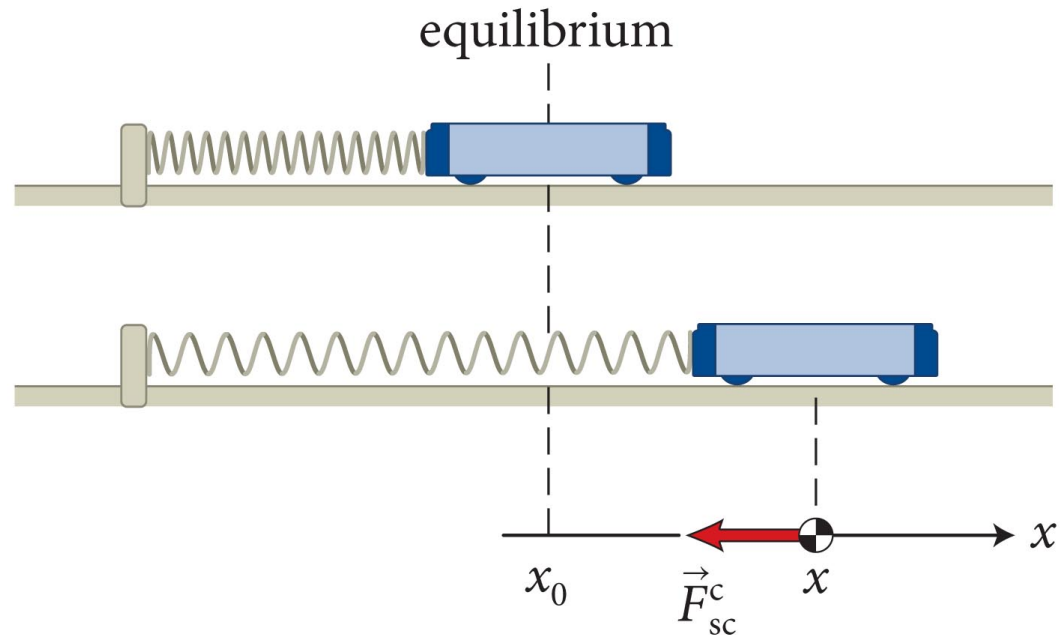

# Section 15.6: Simple harmonic motion and springs

- Looks like  $a_x = -\omega^2 x$ , so we can identify

$$\omega = +\sqrt{\frac{k}{m}}$$

- Therefore, the motion of the cart is given by

$$x(t) = A \sin\left(\sqrt{\frac{k}{m}}t + \phi_1\right)$$

- The figure shows four different solutions that satisfy the equation of motion of the spring-cart system.

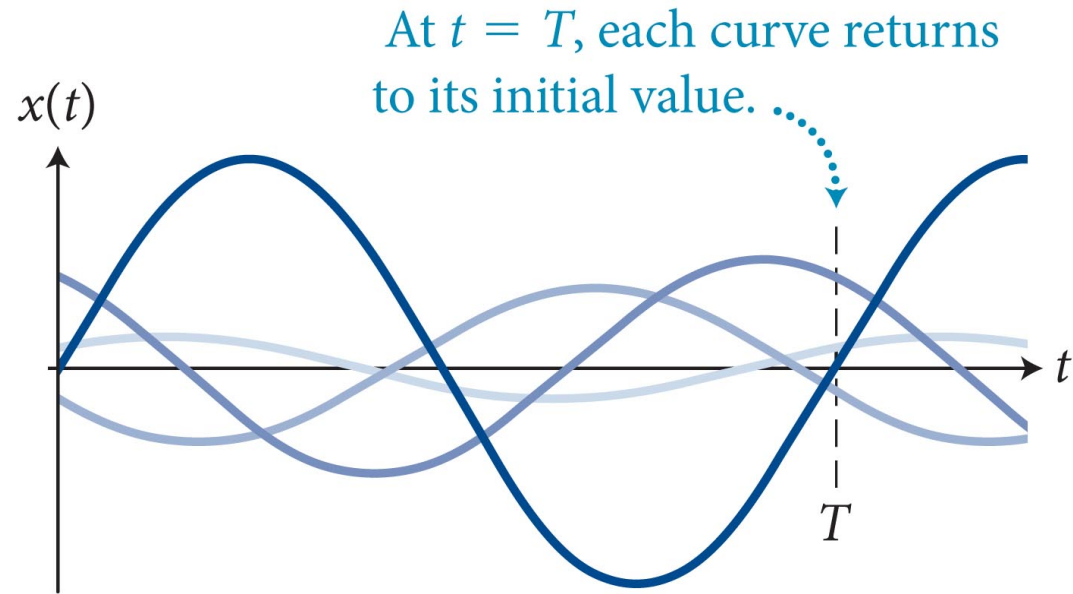

We still need 2 boundary conditions to find  $A$  and  $\phi_1$  to have the unique equation of motion

# Section 15.7: Restoring torques

## Section Goals

You will learn to

- Extend the concept of simple harmonic motion to rotational situations involving **torsional oscillators** and **simple pendulums**.

# Section 15.7: Restoring torques

- Some simple harmonic oscillators involve rotational motion.
  - The torsion oscillator shown is an example of this type of oscillator.
  - The equation of motion for the disk is

$$\Sigma \tau_{\vartheta} = I \alpha_{\vartheta}$$

- For small rotational displacements,

$$\tau_{\vartheta} = -\kappa(\vartheta - \vartheta_0)$$

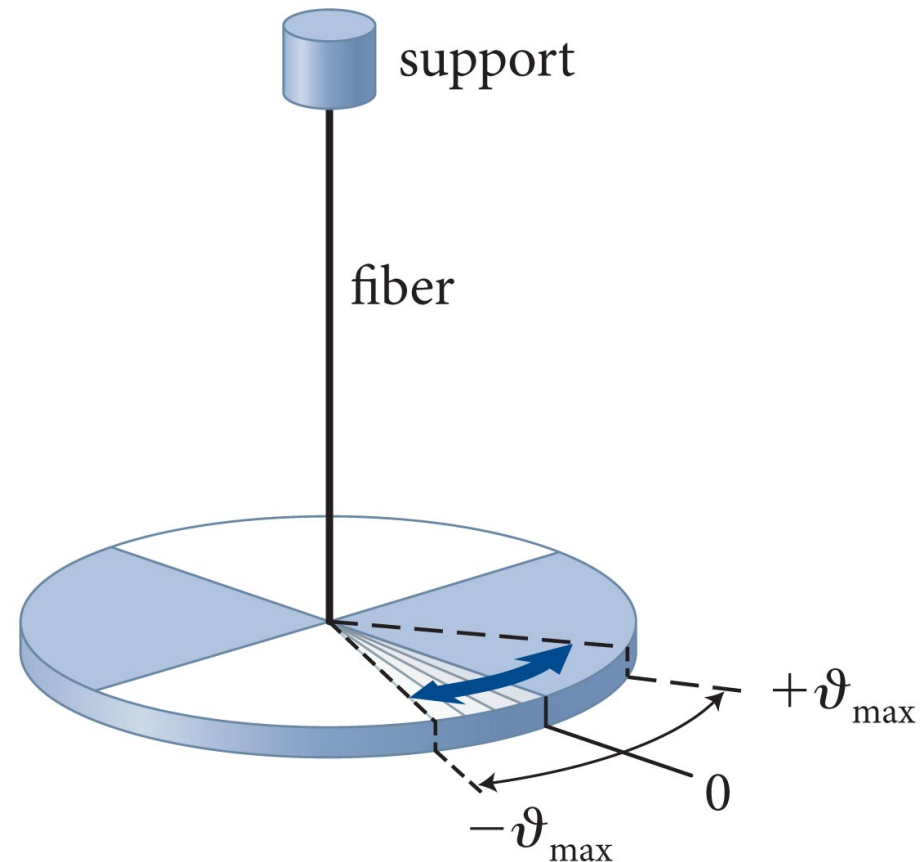

# Section 15.7: Restoring torques

- If  $\theta_0 = 0$ , we get

$$\frac{d^2\vartheta}{dt^2} = -\frac{\kappa}{I}\vartheta$$

- Comparing this equation to Equation 15.21, we can write

$$\theta = \theta_{\max} \sin(\omega t + \varphi_i)$$

$$\omega = \sqrt{\frac{\kappa}{I}} \quad (\text{torsional oscillator})$$

where  $\theta_{\max}$  is the maximum rotational displacement.

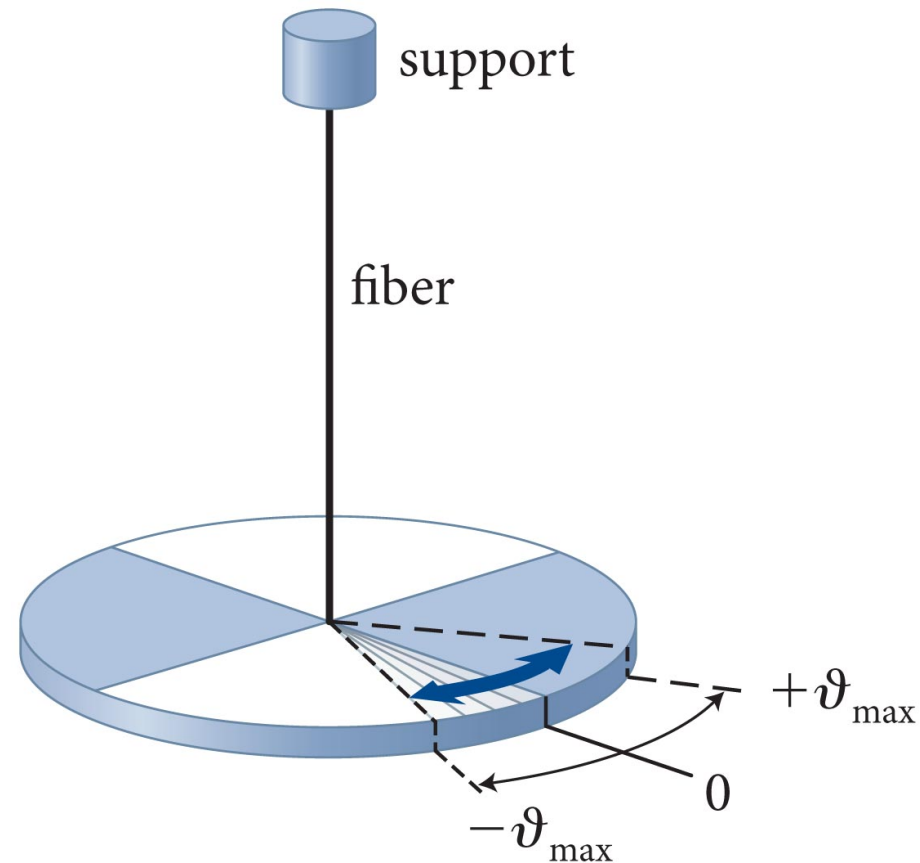

# Checkpoint 15.15

 **15.15** For the torsional oscillator shown in Figure 15.31, what effect, if any, does a decrease in the radius of the disk have on the oscillation frequency  $f$ ? Assume the disk's mass is kept the same.

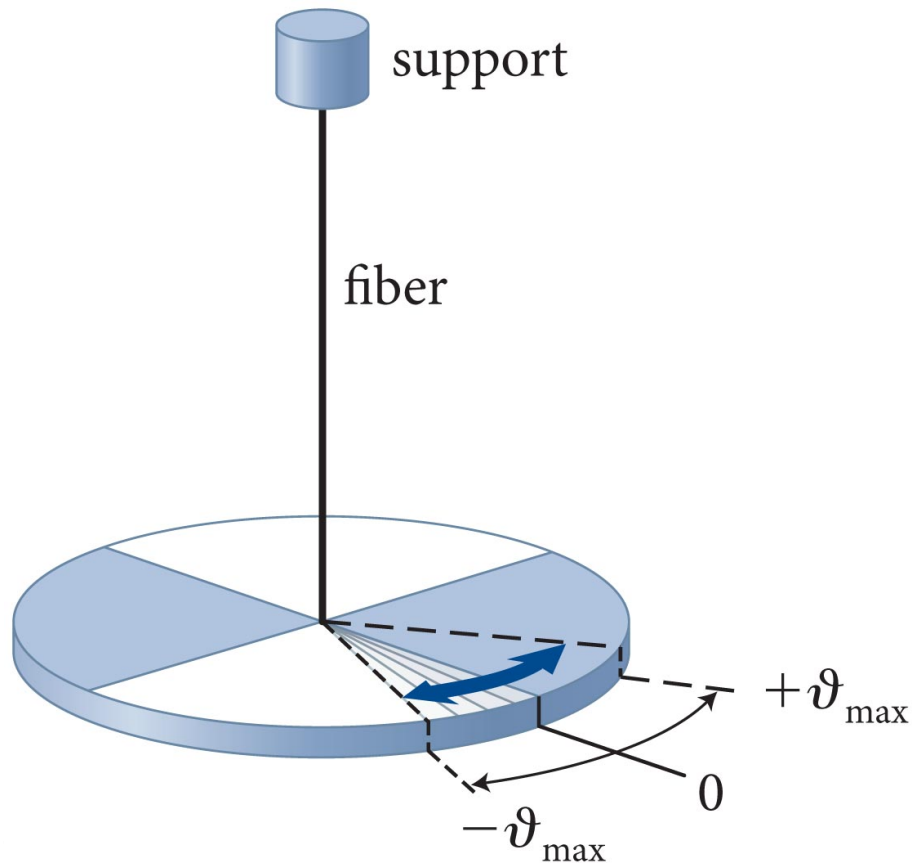

# Checkpoint 15.15

 **15.15** For the torsional oscillator shown in Figure 15.31, what effect, if any, does a decrease in the radius of the disk have on the oscillation frequency  $f$ ? Assume the disk's mass is kept the same.

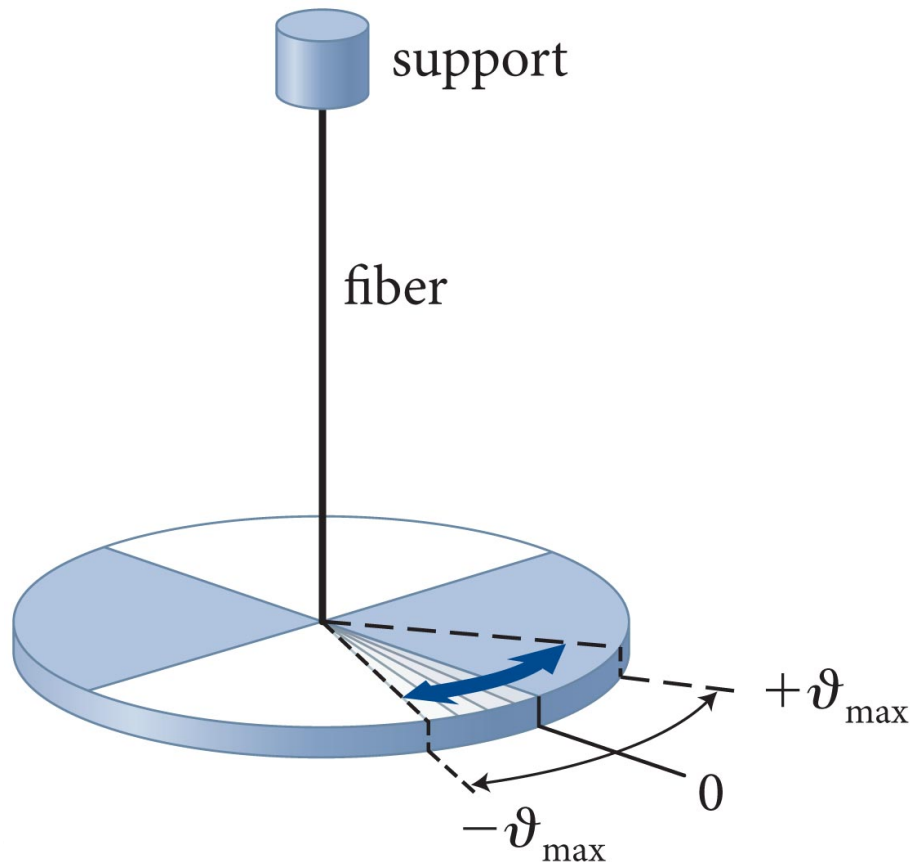

Decreasing the radius reduces its rotational inertia (rotates more easily).

If  $I$  decreases,  $\omega$  increases, so  $f$  increases as well



# Section 15.7: Restoring torques

- The pendulum is another example of a rotational oscillator.

- The torque caused by the force of gravity about the axis is

$$\tau_{\theta} = -\ell_{\text{cm}} (mg \sin\theta)$$

- For small rotational displacements,  $\sin \theta \approx \theta$

$$\tau_{\theta} = - (m\ell_{\text{cm}}g) \theta$$

- Using  $\tau_{\theta} = I\alpha_{\theta} = Id^2\theta/dt^2$ , we get

$$\frac{d^2\vartheta}{dt^2} = -\frac{m\ell_{\text{cm}}g}{I}\vartheta$$

$$\omega = \sqrt{\frac{m\ell_{\text{cm}}g}{I}} \quad (\text{pendulum})$$

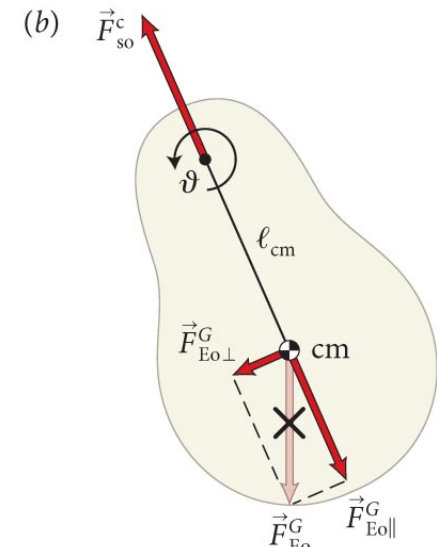
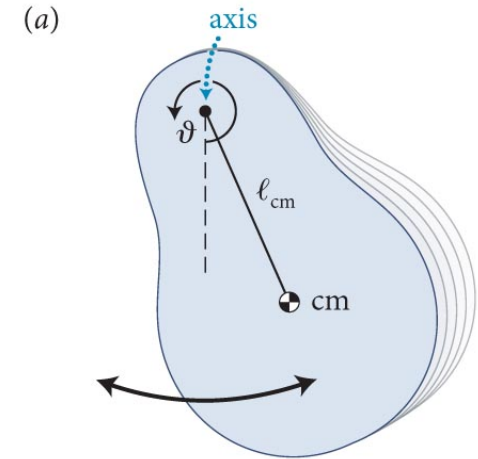

# Section 15.7: Restoring torques

## Example 15.6: The simple pendulum

Suppose a simple pendulum consisting of a bob of mass  $m$  suspended from a string of length  $\ell$  is pulled back and released. What is the period of oscillation of the bob?

# Section 15.7: Restoring torques

## Example 15.6: The simple pendulum (cont.)

### 1 GETTING STARTED I

begin by making a sketch of the simple pendulum (Figure 15.33), indicating the equilibrium position by a vertical dashed line.

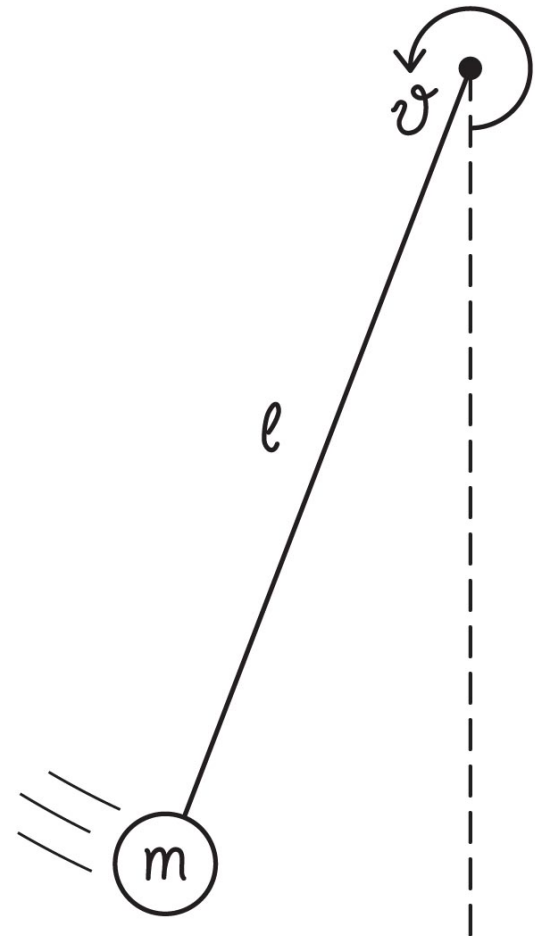

# Section 15.7: Restoring torques

## Example 15.6: The simple pendulum (cont.)

② **DEVISE PLAN** The period of the pendulum is related to the angular frequency (Eq. 15.1). To calculate the angular frequency, I can use Eq. 15.33 with  $\ell_{\text{cm}} = \ell$ .

If I treat the bob as a particle, I know  $I = mr^2$ , with  $r = \ell$ . That gives the bob's rotational inertia about the point of suspension.

## Section 15.7: Restoring torques

### Example 15.6: The simple pendulum (cont.)

③ EXECUTE PLAN Substituting the bob's rotational inertia into Eq. 15.33, I get

$$\omega = \sqrt{\frac{m\ell g}{m\ell^2}} = \sqrt{\frac{g}{\ell}},$$

so, from Eq. 15.1,  $\omega = 2\pi/T$ , I obtain

$$T = \frac{2\pi}{\omega} = 2\pi \sqrt{\frac{\ell}{g}}. \checkmark$$

## Section 15.7: Restoring torques

### Example 15.6: The simple pendulum (cont.)

④ EVALUATE RESULT My result says that  $T$  is independent of the mass  $m$  of the bob, in agreement with what is stated in Section 15.4. Increasing  $g$  decreases the period as it should: A greater  $g$  means a greater restoring force, and so the bob is pulled back to the equilibrium position faster. It also makes sense that increasing  $\ell$  increases the period: As my sketch shows, for greater  $\ell$  the bob has to move a greater distance to return to the equilibrium position.

# Section 15.8: Damped oscillations

## Section Goals

You will learn to

- Integrate the concept of **friction** to oscillatory motion and represent the combined effects graphically.
- Model damped harmonic motion **mathematically**.
- Define the **time constant** for damped harmonic motion.

# Section 15.8: Damped oscillations

- Mechanical oscillators always involve some friction that causes the energy of the oscillator to convert to thermal energy.
- This will cause the oscillator to slow down.
- Such a system is said to execute a **damped oscillation**.
- The figure shows examples of two damped oscillations.

(a) Oscillating block is slowed by friction

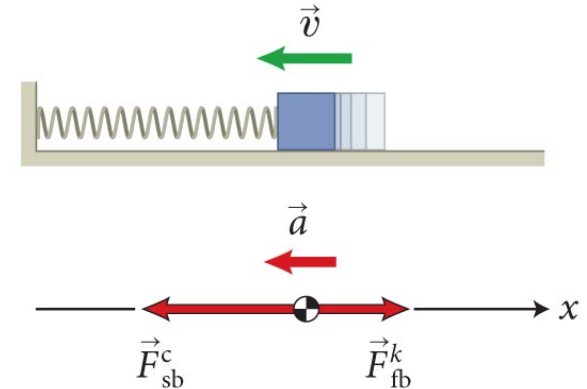

(b) Oscillating cart is slowed by air drag on vane

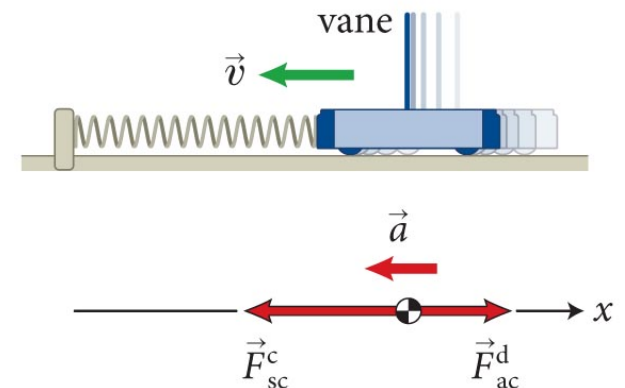



# Section 15.8: Damped oscillations

- The drag force exerted by air and liquids at slow speeds can be modeled as  $\vec{F}_{ac}^d = -b\vec{v}$ , where  $b$  is called the *damping coefficient*.
- In presence of a drag, the equation of motion becomes

$$m \frac{d^2 x}{dt^2} + b \frac{dx}{dt} + kx = 0$$

- The solution of this equation takes the forms

$$x(t) = Ae^{-bt/2m} \sin(\omega_d t + \phi_i)$$

$$\omega_d = \sqrt{\frac{k}{m} - \frac{b^2}{4m^2}} = \sqrt{\omega^2 - \left(\frac{b}{2m}\right)^2}$$

# Section 15.8: Damped oscillations

- The figure shows oscillations for various values of the damping coefficient  $b$ .

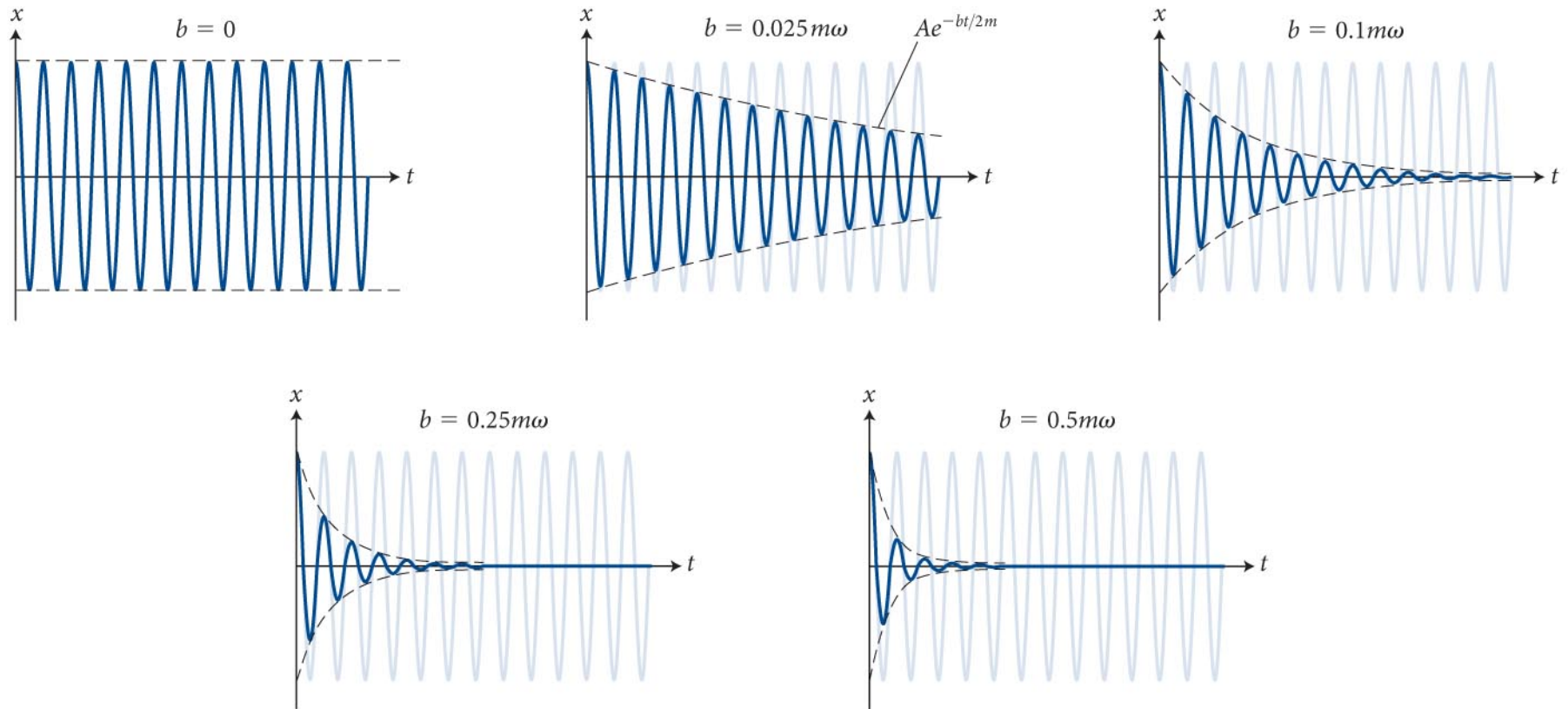

## Section 15.8: Damped oscillations

- The ratio  $m/b$  has units of time and is called the **time constant**:  $\tau \equiv m/b$ .
- Amplitude of the damped oscillation at any given time is given by

$$x_{\max}(t) = Ae^{-t/2\tau}$$

- The mechanical energy of the oscillator can be expressed as

$$E(t) = \frac{1}{2} m\omega^2 x_{\max}^2 = \left(\frac{1}{2} m\omega^2 A^2\right) e^{-t/\tau} = E_0 e^{-t/\tau}$$

# Section 15.6: Simple harmonic motion and springs

## Example 15.4 Cart stuck with spring already compressed

Cart 1 of mass  $m = 0.50$  kg fastened to a spring of spring constant  $k = 14$  N/m is pushed 15 mm in from its equilibrium position and held in place by a ratchet (Figure 15.27). An identical cart 2 is launched at a speed of 0.10 m/s toward cart 1. The carts collide elastically, releasing the ratchet and setting cart 1 in motion.

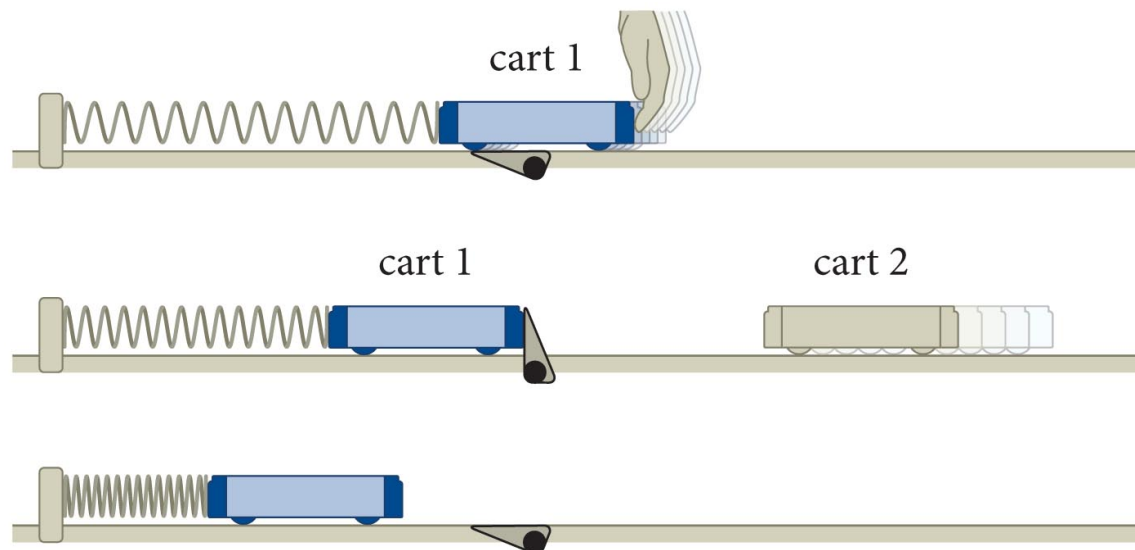

# Section 15.6: Simple harmonic motion and springs

## Example 15.4 Cart stuck with spring already compressed (cont.)

After the collision, cart 2 is immediately removed from the track. (a) What is the maximum compression of the spring? (b) How many seconds elapse between the instant the carts collide and the instant the spring reaches maximum compression?

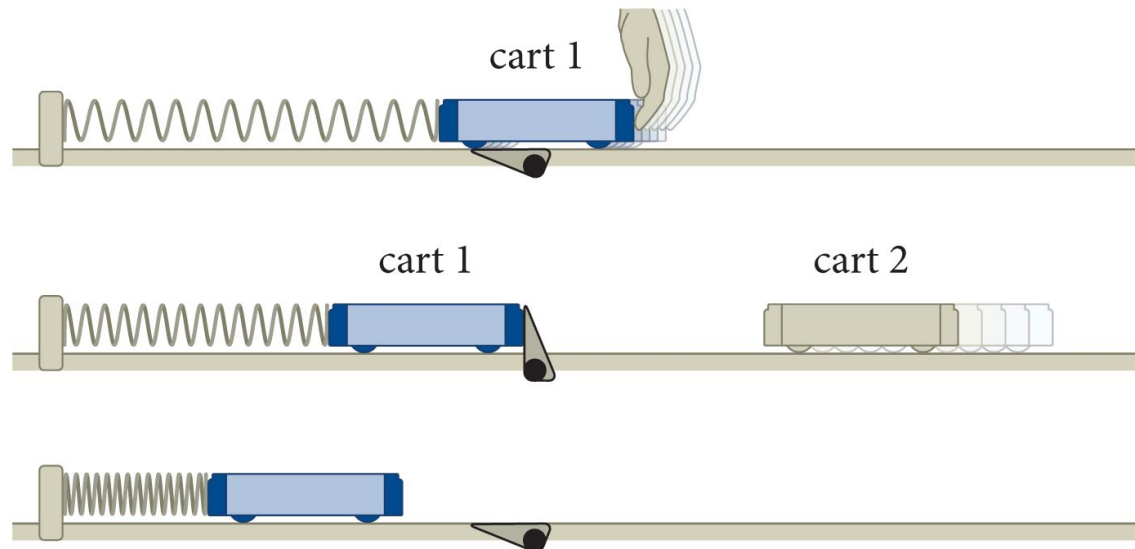

# Section 15.6: Simple harmonic motion and springs

## Example 15.4 Cart stuck with spring already compressed (cont.)

**1** GETTING STARTED If I ignore the effect of the spring during the collision, I can say that the elastic collision interchanges the velocities of the two carts. I make a sketch of the initial condition of cart 1 just before the collision, choosing the positive  $x$  axis to the right, the equilibrium position at  $x = 0$ , and the initial displacement of the cart 15 mm to the left of  $x = 0$ .

# Section 15.6: Simple harmonic motion and springs

## Example 15.4 Cart stuck with spring already compressed (cont.)

**1** GETTING STARTED I also draw a reference circle and sketch the oscillation resulting from the collision (Figure 15.28). With this choice of axis, the  $x$  component of the initial velocity of cart 1 is  $v_{x,i} = -0.10$  m/s. Given  $m$  and  $k$ , and  $\omega^2 = k/m$ ,  $\omega = 5.3$  s<sup>-1</sup>.

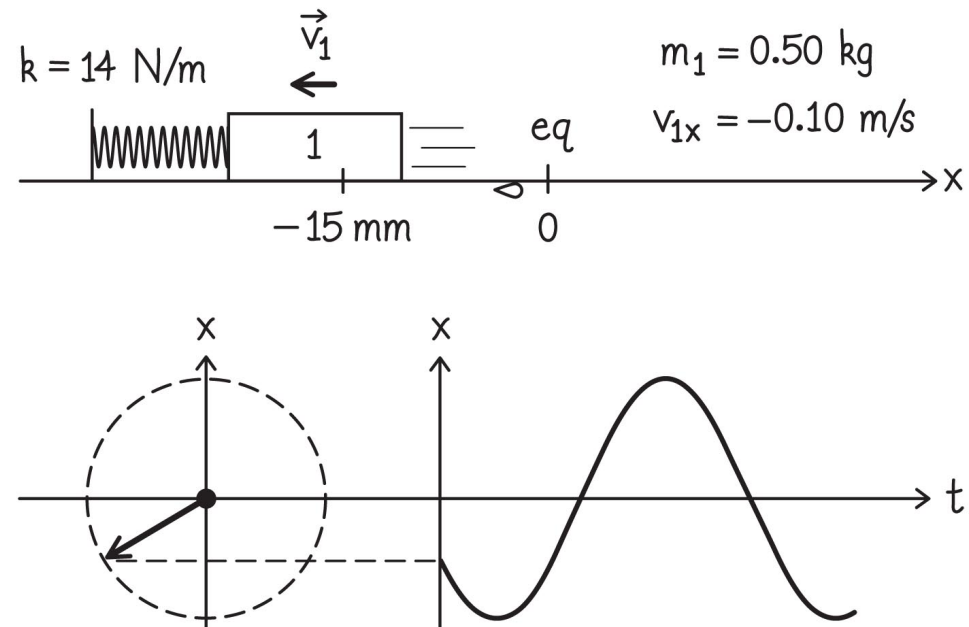

# Section 15.6: Simple harmonic motion and springs

## Example 15.4 Cart stuck with spring already compressed (cont.)

**1** GETTING STARTED In contrast to the situation in Example 15.3, the initial displacement of cart 1 is not equal to the amplitude of the oscillation because the collision increases the cart's displacement from the equilibrium position. In other words, cart 1 moves leftward immediately after the collision. It continues moving in this direction until the elastic restoring force building up in the compressing spring causes the cart to stop. This maximum-compression position gives the amplitude of the oscillation.



# Section 15.6: Simple harmonic motion and springs

## Example 15.4 Cart stuck with spring already compressed (cont.)

② DEVISE PLAN I can determine the value of the amplitude from the mechanical energy of the cart-spring system, which is the sum of the initial potential energy in the spring and the initial kinetic energy of the cart. The potential energy in the spring is given by Eq. 9.23; because the equilibrium position  $x_0$  is at the origin, this equation reduces to  $U_{\text{spring}} = \frac{1}{2} kx^2$ .

# Section 15.6: Simple harmonic motion and springs

## Example 15.4 Cart stuck with spring already compressed (cont.)

② DEVISE PLAN The kinetic energy is given by  $K = \frac{1}{2}mv^2$ . At the position of maximum compression, all of the mechanical energy is stored in the spring,  $x = -A$ , and so  $E_{\text{mech}} = U_{\text{spring}} = \frac{1}{2}kA^2$ .

Once I know  $A$ , I can determine the initial phase from Eq. 15.6. I can then use that same equation to solve for  $t$  at the position of maximum compression, where  $x = -A$ .

# Section 15.6: Simple harmonic motion and springs

## Example 15.4 Cart stuck with spring already compressed (cont.)

**3** EXECUTE PLAN (a) The initial kinetic and potential energies of the cart-spring system are

$$K = \frac{1}{2}(0.50 \text{ kg})(-0.10 \text{ m/s})^2 = 0.0025 \text{ J}$$

$$U = \frac{1}{2}kx^2 = \frac{1}{2}(14 \text{ N/m})(-15 \text{ mm})^2 \left( \frac{1.0 \text{ m}}{1000 \text{ mm}} \right)^2 = 0.0016 \text{ J}$$

So

$$E_{\text{mech}} = K + U = (0.0025 \text{ J}) + (0.0016 \text{ J}) = 0.0041 \text{ J}.$$

# Section 15.6: Simple harmonic motion and springs

## Example 15.4 Cart stuck with spring already compressed (cont.)

**3** EXECUTE PLAN At the position of maximum compression, all of this energy is stored in the spring, and so  $\frac{1}{2}kA^2 = 0.0041 \text{ J}$ , or with the  $k$  value given,

$$A = \sqrt{\frac{2(0.0041 \text{ J})}{14 \text{ N/m}}} = 0.024 \text{ m} = 24 \text{ mm. } \checkmark$$

# Section 15.6: Simple harmonic motion and springs

## Example 15.4 Cart stuck with spring already compressed (cont.)

③ EXECUTE PLAN (b) Substituting the value for  $A$  determined in part  $a$  and the initial condition  $x_i = -15$  mm at  $t = 0$  into Eq. 15.6, I obtain

$$x(0) = A \sin(0 + \phi_i) = (24 \text{ mm}) \sin \phi_i = -15 \text{ mm}$$

$$\sin \phi_i = \frac{-15 \text{ mm}}{24 \text{ mm}} = -0.63 \quad \text{or} \quad \phi_i = \sin^{-1}(-0.63).$$

# Section 15.6: Simple harmonic motion and springs

## Example 15.4 Cart stuck with spring already compressed (cont.)

**3** EXECUTE PLAN Two initial phases satisfy this relationship,  $\phi_i = -0.68$  and  $\phi_i = -\pi + 0.68 = -2.5$ , but only the latter gives a negative  $x$  component of the velocity (see Eq. 15.7), as required by the initial condition.

At the first instant of maximum compression,  $\sin(\omega t + \phi_i) = -1$ , which means  $\omega t = \phi_i = -\frac{1}{2}\pi$ . Solving for  $t$  yields  $t = (-\frac{1}{2}\pi - \phi_i) / \omega = [-\frac{1}{2}\pi - (-2.5)] / (5.3 \text{ s}^{-1}) = 0.17 \text{ s}$ . ✓

# Section 15.6: Simple harmonic motion and springs

## Example 15.4 Cart stuck with spring already compressed (cont.)

④ EVALUATE RESULT At 24 mm, the amplitude is greater than the 15-mm initial displacement from the equilibrium position, as I would expect. From the reference circle part of my sketch I see that it takes about one-eighth of a cycle to go from the position of impact to the position of maximum compression.

# Section 15.6: Simple harmonic motion and springs

## Example 15.4 Cart stuck with spring already compressed (cont.)

④ EVALUATE RESULT From Eq. 15.1 I see that the number of seconds needed to complete one cycle is  $T = 2\pi/\omega = 2\pi/(5.3 \text{ s}^{-1}) = 1.2 \text{ s}$ , and so the 0.17-s value I obtained for seconds elapsed between collision and maximum compression is indeed close to one-eighth of a cycle.



# Section 15.6: Simple harmonic motion and springs

## Example 15.4 Cart stuck with spring already compressed (cont.)

④ EVALUATE RESULT The assumption that the influence of the spring can be ignored during the collision is justified because the force exerted by the spring is small relative to the force of the impact: At a compression of 15 mm, the magnitude of the force exerted by the spring is  $(14 \text{ N/m})(0.015 \text{ m}) = 0.21 \text{ N}$ .

# Section 15.6: Simple harmonic motion and springs

## Example 15.4 Cart stuck with spring already compressed (cont.)

④ EVALUATE RESULT The force of impact is given by the time rate of change in the cart's momentum,  $\Delta\vec{p}/\Delta t$ . The magnitude of the momentum change is  $\Delta p = m\Delta v = (0.50 \text{ kg})(0.10 \text{ m/s}) = 0.050 \text{ kg}\cdot\text{m/s}$ . If the collision takes place in, say, 20 ms, the magnitude of the force of impact is  $(0.050 \text{ kg}\cdot\text{m/s})/(0.020 \text{ s}) = 2.5 \text{ N}$ , which is more than 10 times greater than the magnitude of the force exerted by the spring.

# Section 15.6: Simple harmonic motion and springs

## Example 15.5 Vertical oscillations

A block of mass  $m = 0.50$  kg is suspended from a spring of spring constant  $k = 100$  N/m. (a) How far below the end of the relaxed spring at  $x_0$  is the equilibrium position  $x_{\text{eq}}$  of the suspended block (Figure 15.29a)?

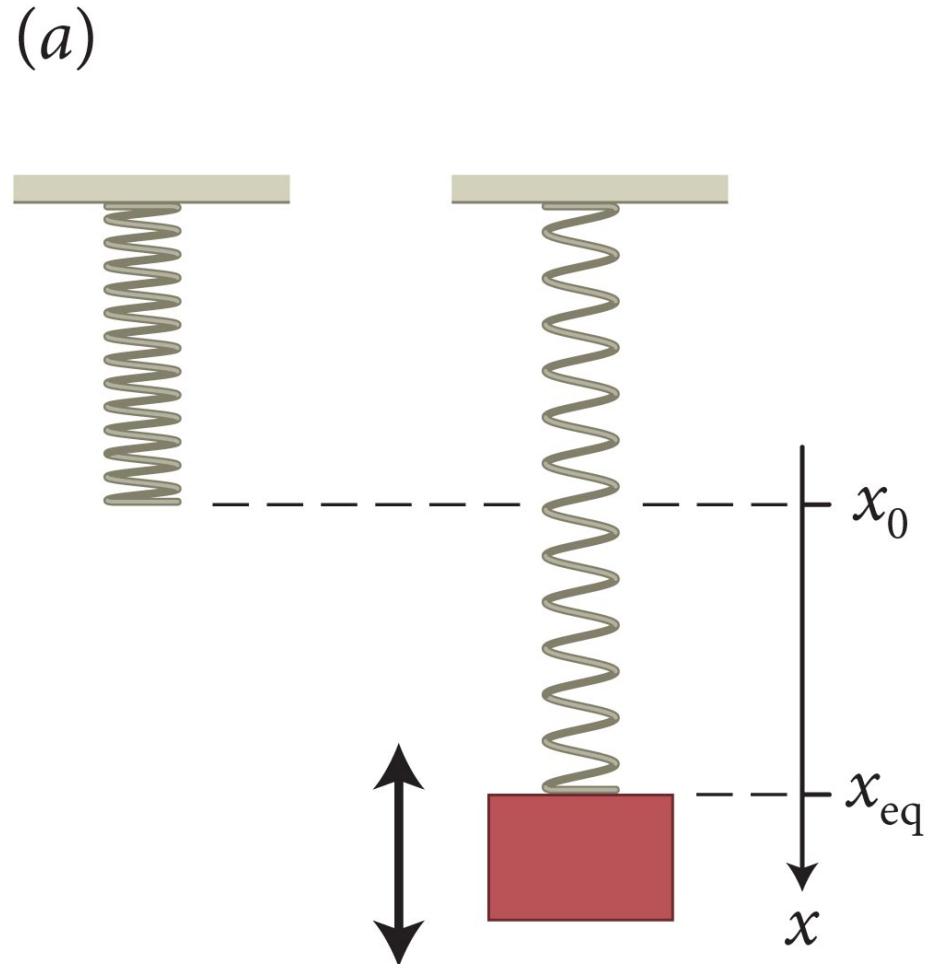

# Section 15.6: Simple harmonic motion and springs

## Example 15.5 Vertical oscillations (cont.)

(b) Is the frequency  $f$  with which the block oscillates about this equilibrium position  $x_{\text{eq}}$  greater than, smaller than, or equal to that of an identical system that oscillates horizontally about  $x_0$  on a surface for which friction can be ignored (Figure 15.29b)?

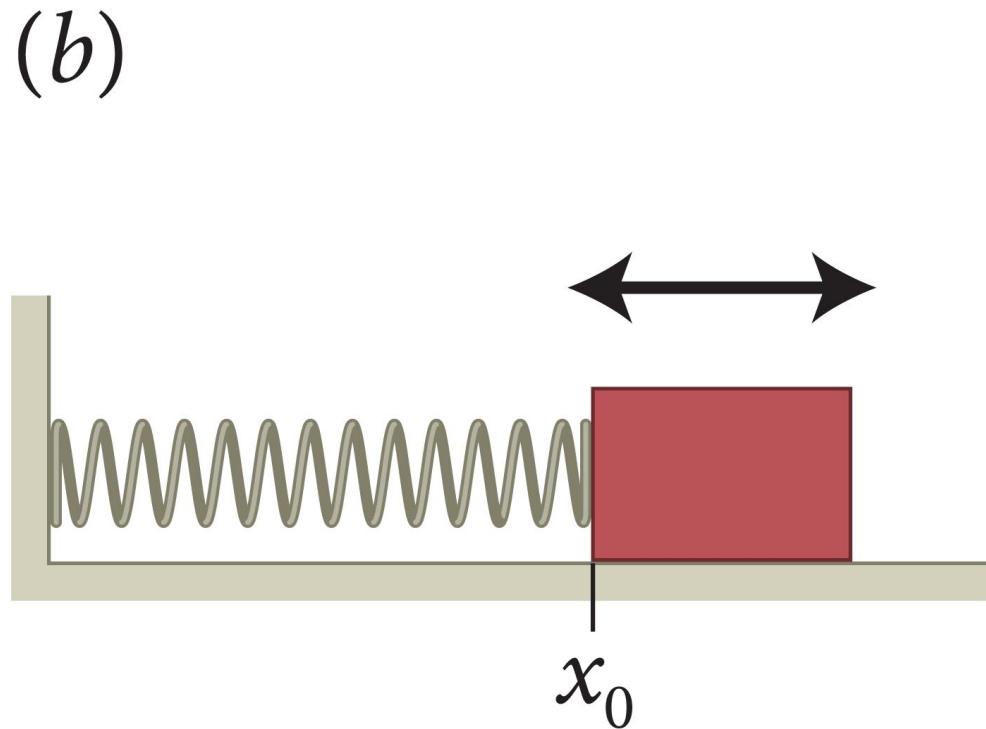

# Section 15.6: Simple harmonic motion and springs

## Example 15.5 Vertical oscillations (cont.)

**1** GETTING STARTED I begin by making a free-body diagram for the suspended block, choosing the positive  $x$  axis pointing downward. Two forces are exerted on the block: an upward force  $\vec{F}_{sb}^c$  exerted by the spring and a downward gravitational force  $\vec{F}_{Eb}^G$  exerted by Earth (Figure 15.30a).

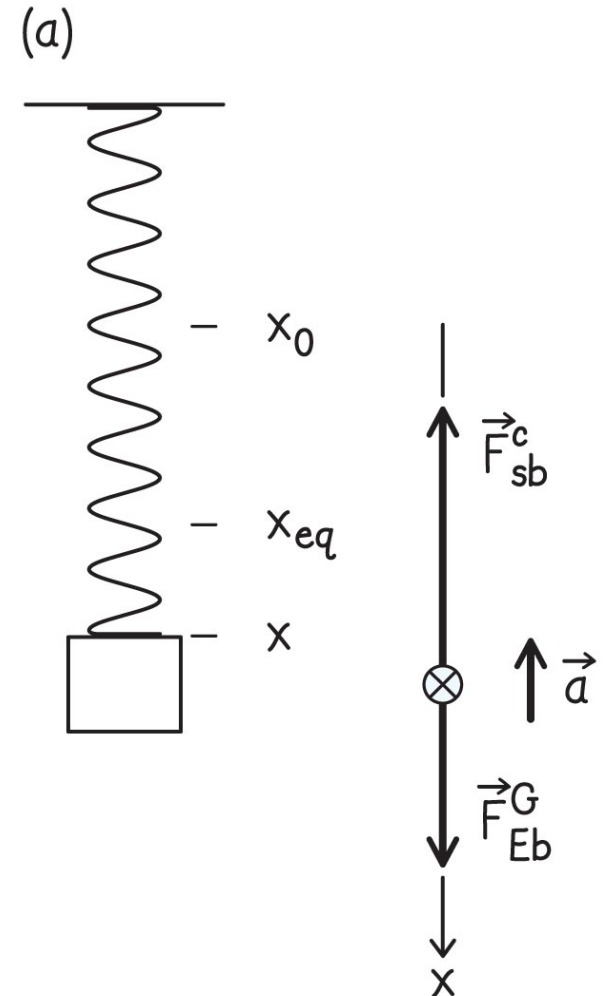

# Section 15.6: Simple harmonic motion and springs

## Example 15.5 Vertical oscillations (cont.)

**1** GETTING STARTED When the suspended block is in translational equilibrium at  $x_{eq}$  (which lies below  $x_0$ ), the vector sum of these forces must be zero. With the block at  $x_{eq}$ , the spring is stretched such that the end attached to the block is also at  $x_{eq}$ .

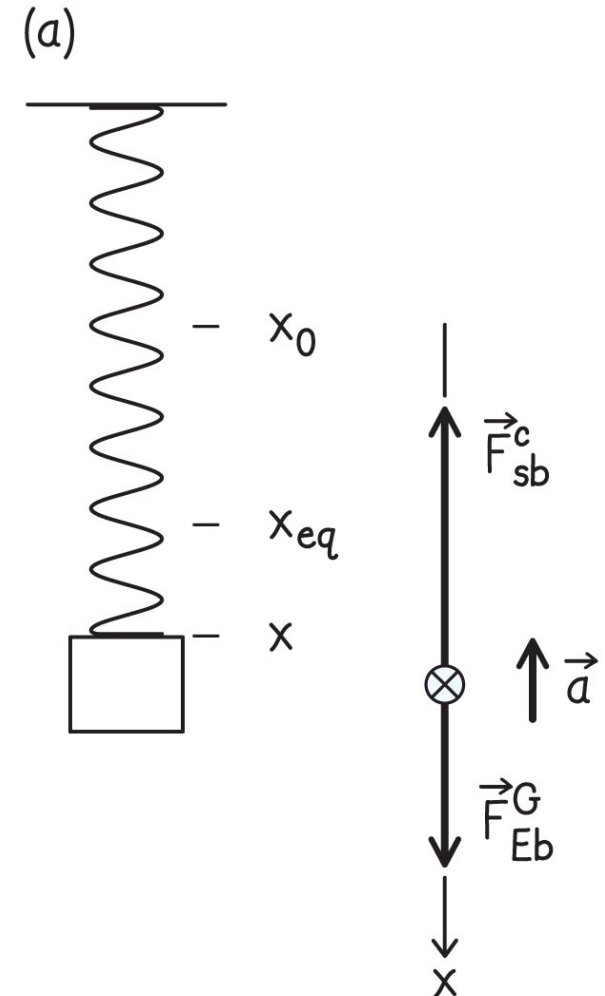

# Section 15.6: Simple harmonic motion and springs

## Example 15.5 Vertical oscillations (cont.)

**1** GETTING STARTED When the block is below  $x_{eq}$ , the spring is stretched farther, causing the magnitude of  $\vec{F}_{sb}^c$  to increase, and so now the vector sum of the forces exerted on the block points upward.

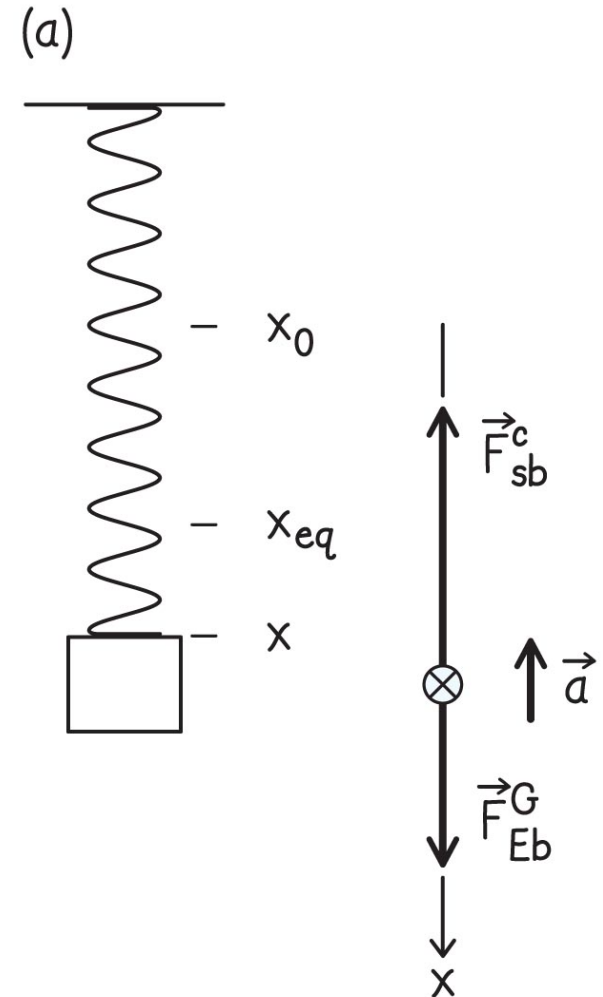

# Section 15.6: Simple harmonic motion and springs

## Example 15.5 Vertical oscillations (cont.)

**1** GETTING STARTED When the block is above  $x_{\text{eq}}$  (but below the position  $x_0$  of the end of the spring when it is relaxed), the spring is stretched less than when the block is at  $x_{\text{eq}}$ , causing the magnitude of  $\vec{F}_{\text{sb}}^{\text{c}}$  to decrease, and so the vector sum of the forces exerted on the block points downward. The vector sum of  $\vec{F}_{\text{sb}}^{\text{c}}$  and  $\vec{F}_{\text{Eb}}^{\text{G}}$  thus serves as a restoring force.

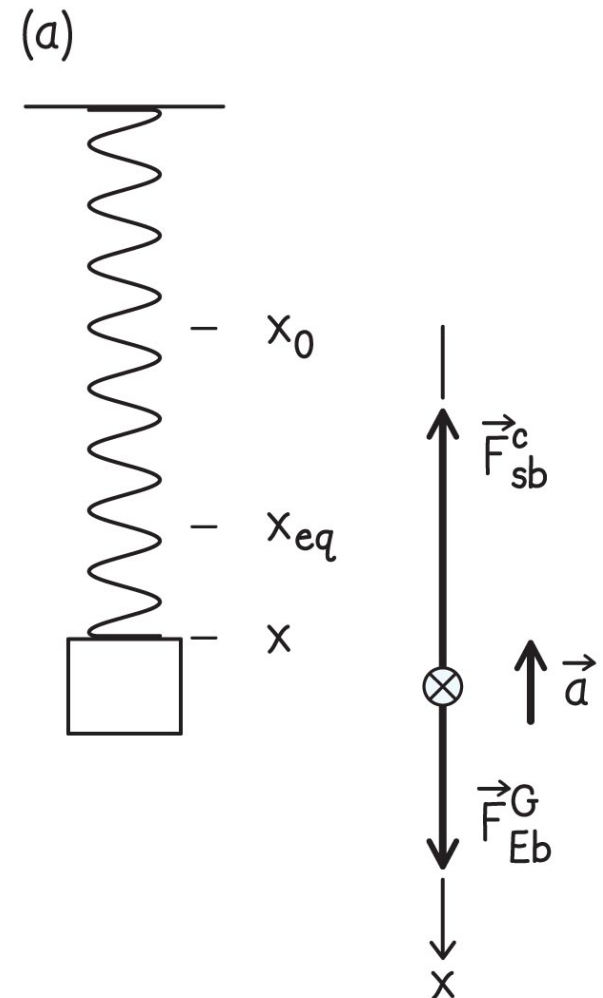



# Section 15.6: Simple harmonic motion and springs

## Example 15.5 Vertical oscillations (cont.)

**1** GETTING STARTED I also make a free-body diagram for the horizontal arrangement (Figure 15.30b), showing only the horizontal forces (the force of gravity and the normal force exerted by the surface cancel out). I let the positive  $x$  axis point to the right. In this case, the restoring force is  $\vec{F}_{sb}^c$  only.

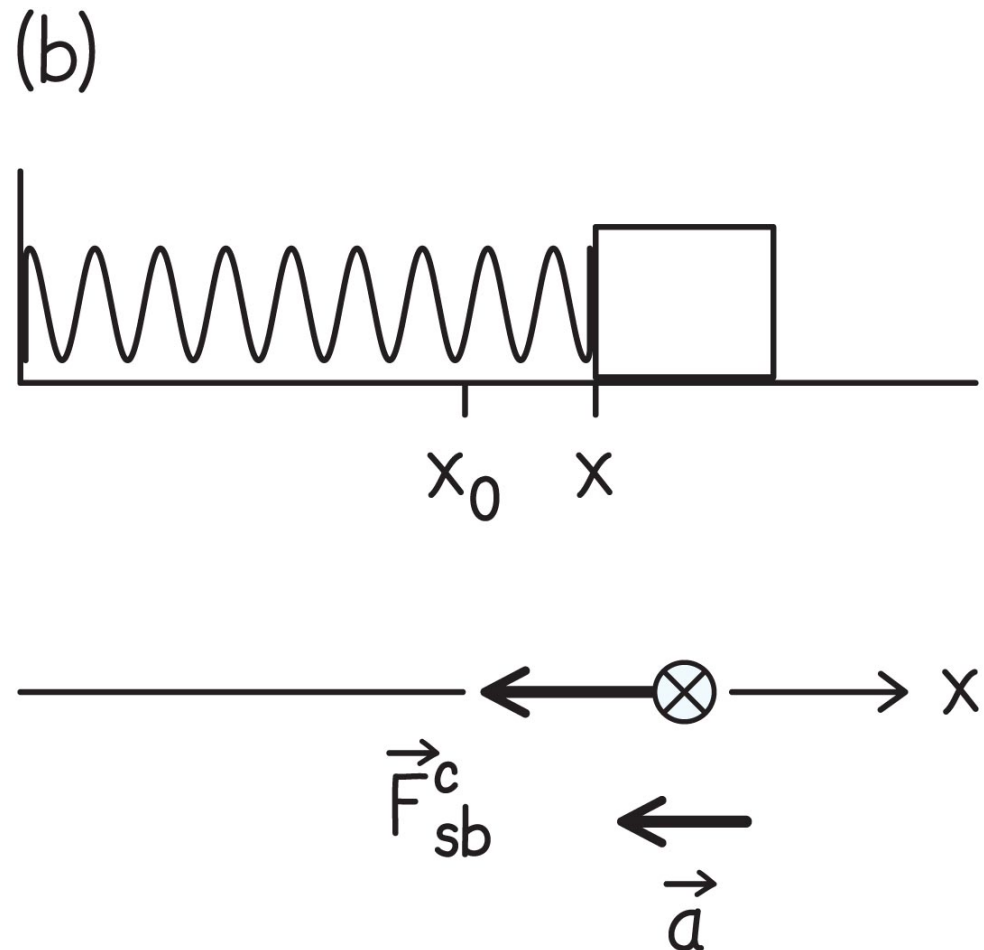

# Section 15.6: Simple harmonic motion and springs

## Example 15.5 Vertical oscillations (cont.)

② **DEVISE PLAN** In translational equilibrium, the vector sum of the forces exerted on the suspended block is zero, and so I can determine the magnitude of the force exerted by the spring. I can then use Hooke's law (Eq. 8.20) to determine the distance between the equilibrium position and  $x_0$ . To compare the oscillation frequencies of the two systems, I should write the simple harmonic oscillator equation for each system in the form given by Eq. 15.12.

# Section 15.6: Simple harmonic motion and springs

## Example 15.5 Vertical oscillations (cont.)

**3** EXECUTE PLAN (a) For translational equilibrium, I have

$$\Sigma F_x = F_{sb\ x}^c + F_{Eb\ x}^G = -k(x_{eq} - x_0) + mg = 0,$$

where  $x_{eq} - x_0$  is the displacement of the spring's end from its relaxed position. Solving for  $x_{eq} - x_0$ , I obtain

$$x_{eq} - x_0 = \frac{mg}{k} = \frac{(0.50 \text{ kg})(9.8 \text{ m/s}^2)}{100 \text{ N/m}} = 0.049 \text{ m.} \checkmark$$

# Section 15.6: Simple harmonic motion and springs

## Example 15.5 Vertical oscillations (cont.)

③ EXECUTE PLAN (*b*) For the horizontal arrangement, I have in the situation depicted in my sketch (Figure 15.30*b*)

$$\Sigma F_x = F_{sbx}^c = -k(x - x_0) \quad (1)$$

so if I let the origin of my  $x$  axis be at the position of the end of the relaxed spring,  $x_0 = 0$ , the rightmost factor in Eq. 1 reduces to  $-kx$  and thus  $\Sigma F_x = -kx$ .

# Section 15.6: Simple harmonic motion and springs

## Example 15.5 Vertical oscillations (cont.)

**3** EXECUTE PLAN Next I turn to the vertical arrangement. In the position illustrated in Figure 15.30*a*, the  $x$  component of the upward force exerted by the spring is

$$F_{sb,x}^c = -k(x - x_0) = -k(x - x_{eq}) - k(x_{eq} - x_0). \quad (2)$$

# Section 15.6: Simple harmonic motion and springs

## Example 15.5 Vertical oscillations (cont.)

③ EXECUTE PLAN From part *a* I know that  $k(x_{\text{eq}} - x_0)$  is equal to  $mg$ . The  $x$  component of the vector sum of the forces exerted on the block at position  $x$  is thus

$$\begin{aligned}\Sigma F_x &= F_{\text{Eb}x}^G + F_{\text{sb}x}^c = mg - k(x - x_{\text{eq}}) - mg \\ &= -k(x - x_{\text{eq}}).\end{aligned}$$

# Section 15.6: Simple harmonic motion and springs

## Example 15.5 Vertical oscillations (cont.)

③ EXECUTE PLAN If, as usual, I let the origin be at the equilibrium position,  $x_{\text{eq}} = 0$ , then this result for  $\Sigma F_x$  is identical to Eq. 1. Comparing these results to Eq. 15.12, I see that in both cases  $k = m \omega^2$  and so the oscillation frequencies  $f = \omega/2\pi$  of the two systems are the same:  $f_{\text{vert}} = f_{\text{hor}}$ . ✓

# Section 15.6: Simple harmonic motion and springs

## Example 15.5 Vertical oscillations (cont.)

④ EVALUATE RESULT The two oscillations take place about different equilibrium positions ( $x_0$  for the horizontal case,  $x_{\text{eq}}$  for the vertical case), but the effect of the combined gravitational and elastic forces in the vertical arrangement is the same as that of just the elastic force in the horizontal arrangement because the force exerted by the spring is linear in the displacement.



# Section 15.6

## Question 6

If you know the mass of an object hanging from a spring in an oscillating system, what else do you need to know to determine the period of the motion?

Answer all that apply.

1. The spring constant
2. The initial velocity
3. The angular frequency
4. The amplitude

# Section 15.6

## Question 6

If you know the mass of an object hanging from a spring in an oscillating system, what else do you need to know to determine the period of the motion?

Answer all that apply.

- ✓ 1. The spring constant
- 2. The initial velocity
- 3. The angular frequency
- 4. The amplitude