

PRINCIPLES & PRACTICE OF
PHYSICS

Chapter 18
Fluids

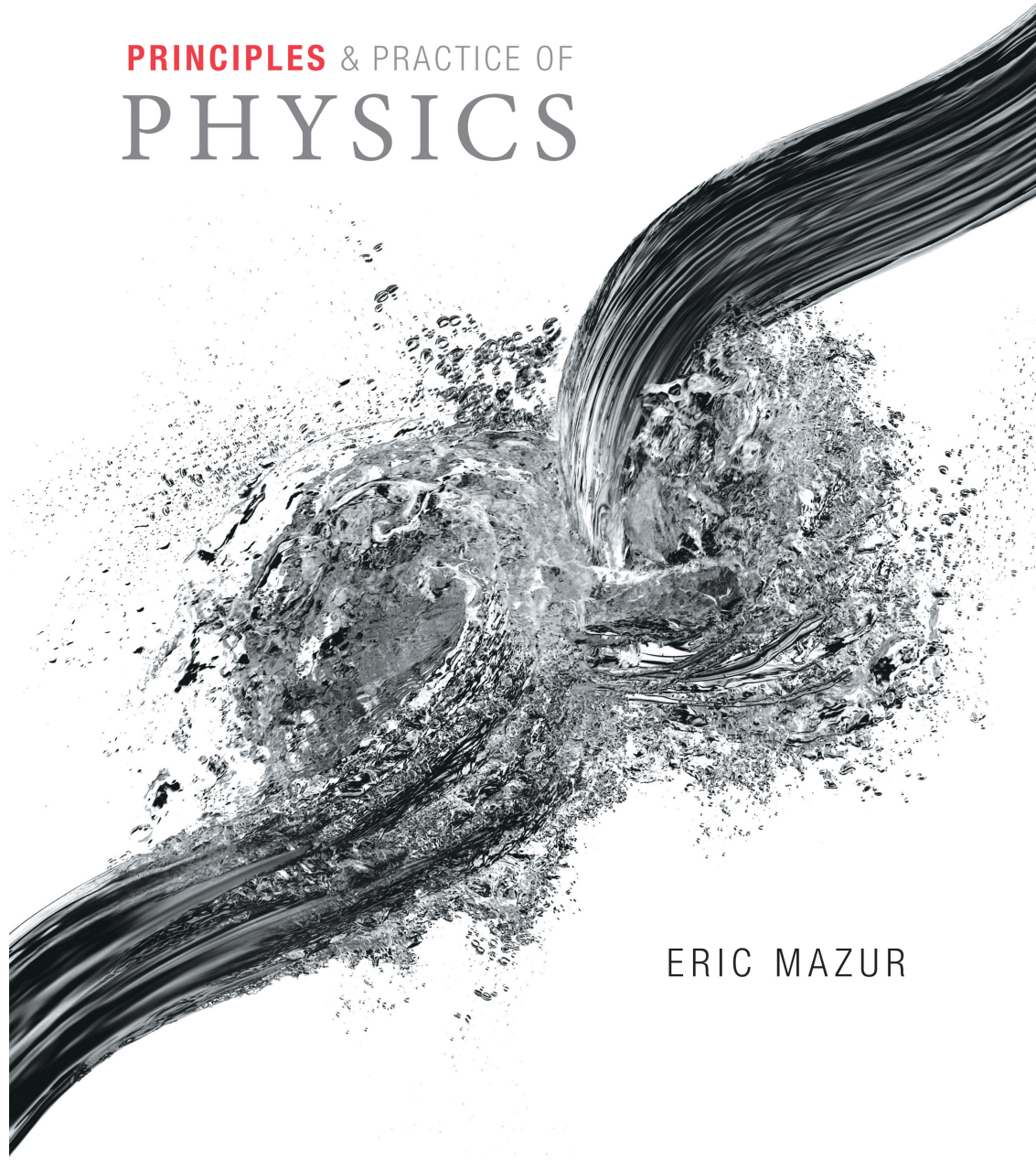

ERIC MAZUR

Section 18.1: Forces in a fluid

- We dealt with solid objects in the previous chapters.
- We now turn our attention to liquids and gasses.
- Liquids and gasses are collectively called **fluids** because they flow.
- Push on a solid? It moves in that direction.
- Push on a liquid? It moves in all other directions too.
 - We need something more complicated than a vector now. $F=ma$ if F and a are in different directions?

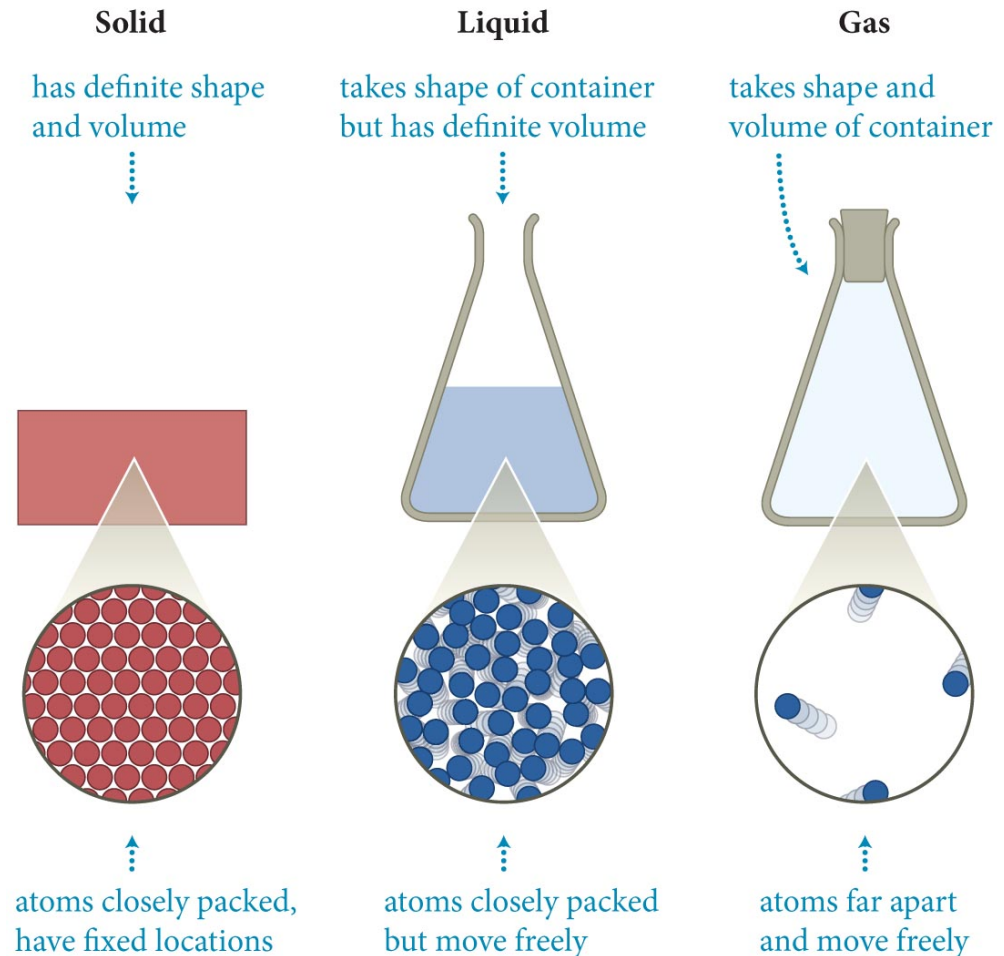

Section 18.1: Forces in a fluid

- Let us begin by examining how solid objects respond to equal forces applied in opposite directions.
- Such forces acting on stationary solid objects cause either *tensile/compressive stress*, *bulk stress*, or, *shear stress* as illustrated in the figure.

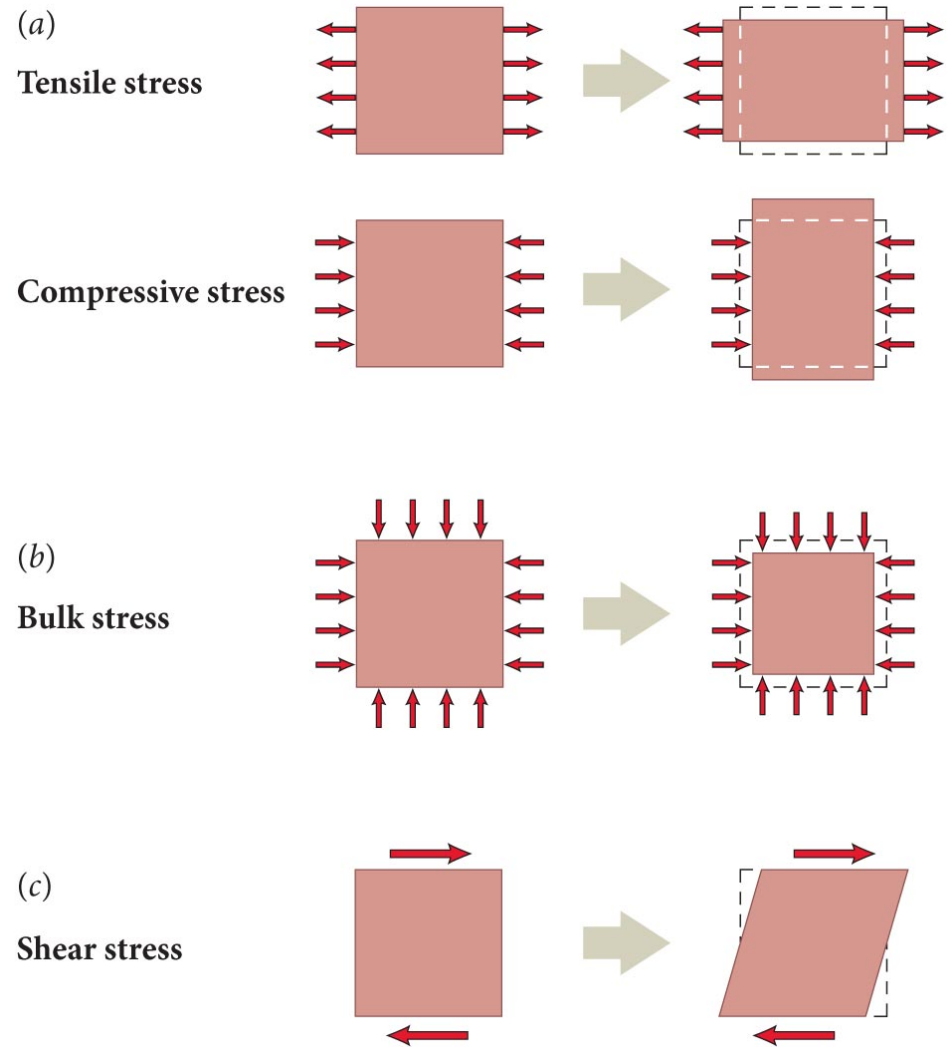

Section 18.1: Forces in a fluid

- Let us now examine how a fluid responds to these same three types of stresses.
 - **When a gas is subject to bulk stress, its mass density and volume change easily.**
 - **When a liquid is subjected to bulk stress, its mass density and volume are nearly unchanged (~ppb).**
 - *Nonviscous* fluids do not support static tensile (pulling) or shear stress.
 - There are two such fluids known, near absolute zero.

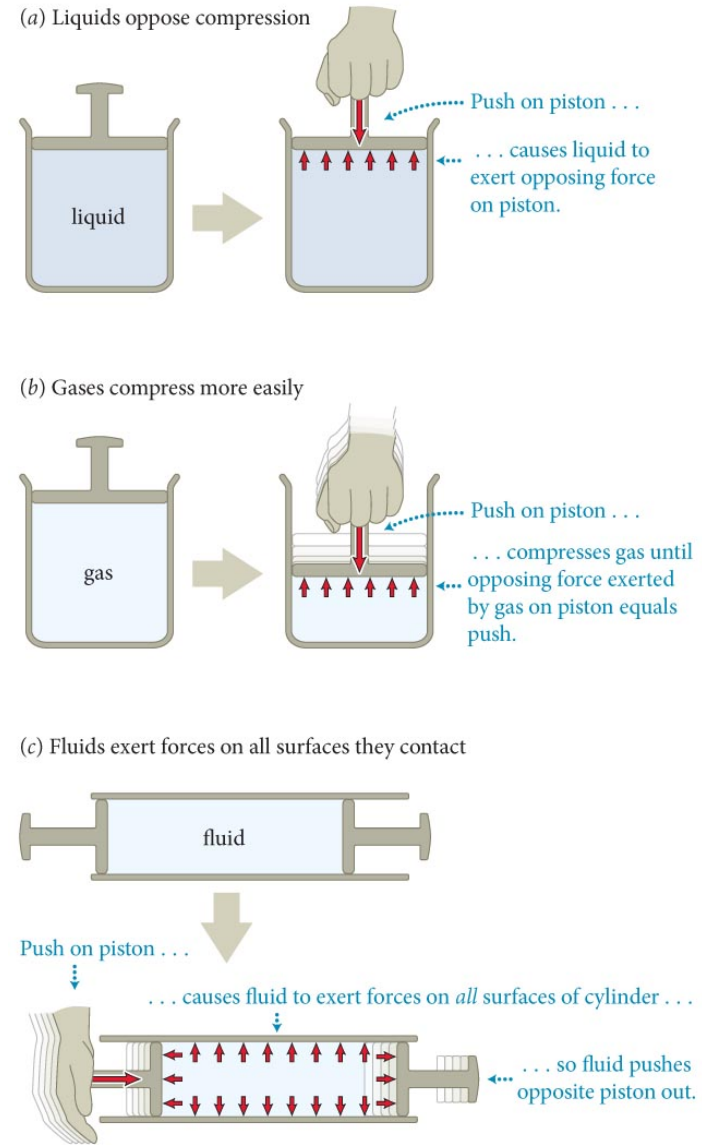

Wait. That doesn't sound right.

- **When a liquid is subjected to bulk stress, its mass density and volume can be considered unchanged.**
 - This is roughly true – the change in density and volume is incredibly small, ppb level. For most situations, negligible.
 - It cannot be *completely* true, however. Nothing is really *incompressible* – a force can't just do nothing at all
 - How do you hear anything underwater?
- *Nonviscous* fluids do not support static tensile or shear stress.
 - Only liquid helium (two isotopes) near absolute zero actually does this (and it is awesome)
 - Ignoring viscosity amounts to a theory of 'dry water', but it is still very useful

Section 18.1: Forces in a fluid

Seriously, can't we just ignore viscosity?

- I mean, isn't it like air resistance or friction?
- What could possibly go wrong if we left out viscosity?

- It gets weird.
- <https://www.youtube.com/watch?v=MFKobSi4NTY>

Checkpoint 18.1

 **18.1** In Figure 18.3c, suppose you push the left piston rightward with a force of magnitude 10 N. (a) To keep the water in the cylinder at rest, what force must you exert on the (identical) right piston? (b) How does the force $\vec{F}_{\text{wr}}^{\text{c}}$ exerted by the water on the right piston compare to the force $\vec{F}_{\text{pl}}^{\text{c}}$ exerted by you on the left piston?

(c) Fluids exert forces on all surfaces they contact

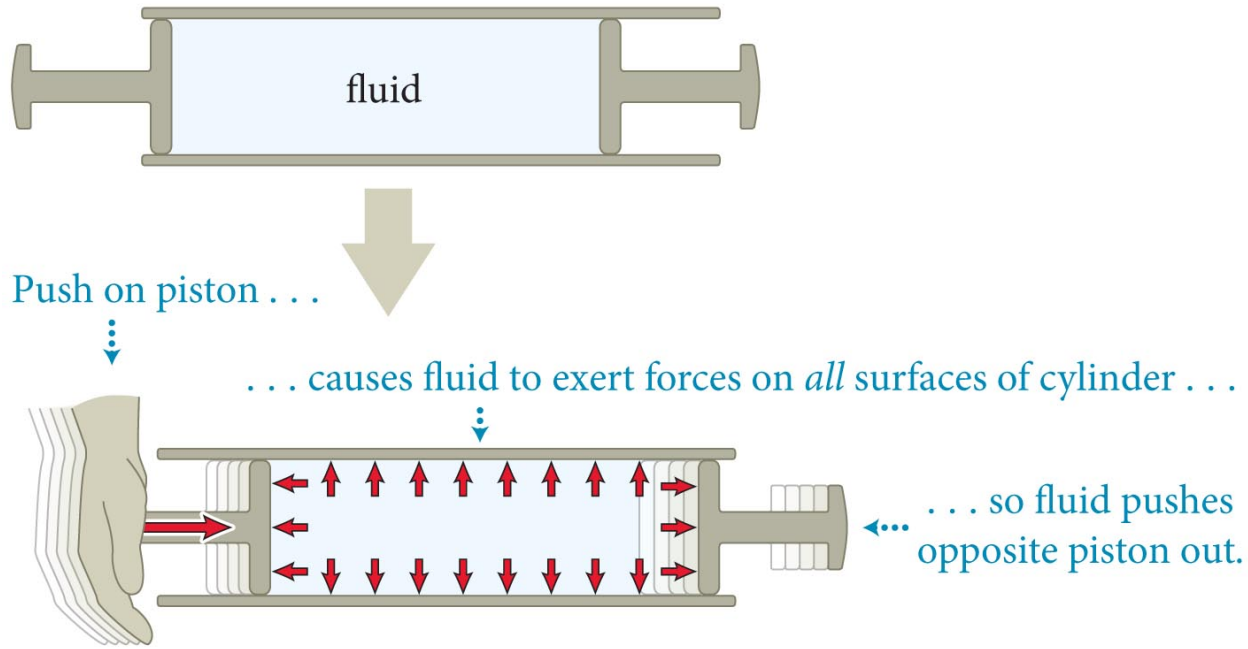

Checkpoint 18.1

- a) If the water stays at rest, no net force. That means you have to apply 10-N leftward
- b) The force you exert on the left piston is transmitted by the water to the right piston. Consider the interaction pairs:

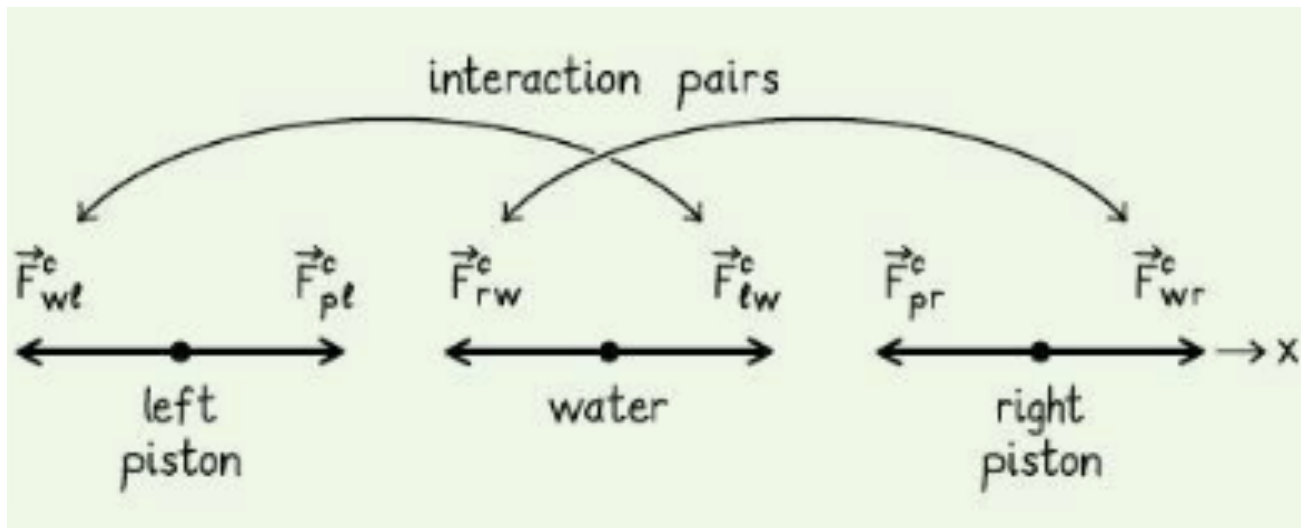

Section 18.1: Forces in a fluid

- Consider a fluid subject to a compressive stress in a cylinder, as shown. The fluid is in mechanical equilibrium.
 - The vector sum of the three forces \vec{F}_1 , \vec{F}_2 , and \vec{F}_3 acting on the three surfaces of the imaginary wedge-shaped volume is zero.
 - The three wedge-shaped surfaces have areas A_1 , A_2 , A_3 .

(a) Wedge-shaped volume in fluid at rest

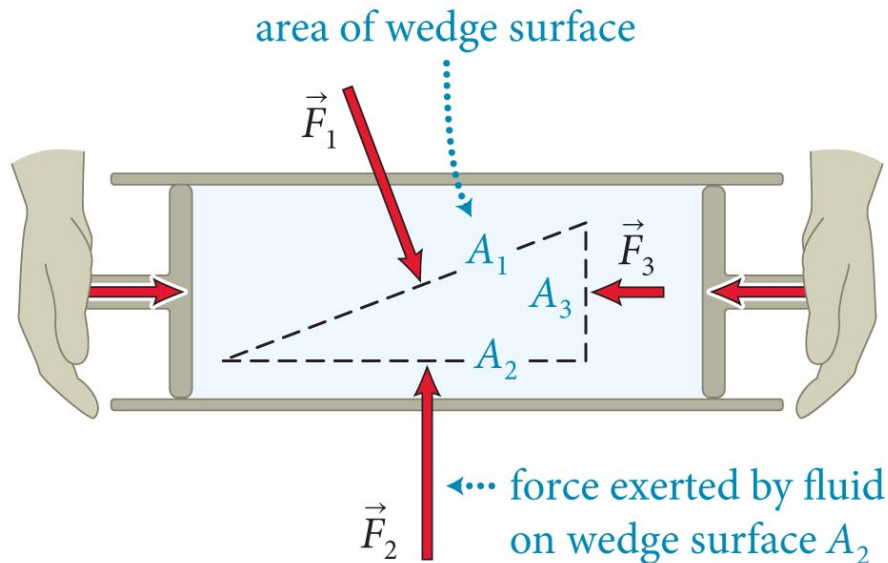

(b) Vector sum of forces exerted on wedge is zero

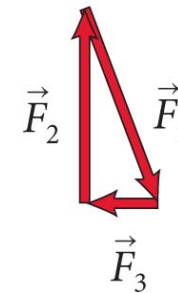

Section 18.1: Forces in a fluid

- We can show that $F_1/A_1 = F_2/A_2 = F_3/A_3$.
- This ratio of the force to the area on which the force is exerted is called the **pressure** P , or $P = F/A$.
- Pressure is a scalar quantity and has SI units: N/m^2 .
- Because of the mobility of the particles in a fluid, pressure is transmitted in all directions to all parts of the fluid.

(If it were not? The net force on one parcel of fluid would cause it to move to a spot with lower force, tending to smooth out any differences.)

Section 18.1: Forces in a fluid

- As illustrated in the figure, pressure in gasses can only be positive. Gasses have to be contained, which means compression.
- Liquids, however, can sustain negative pressures. (Think surface tension.)

(a) Because liquid particles exert attractive forces on each other and on the container walls, liquid can hold piston up against force of gravity

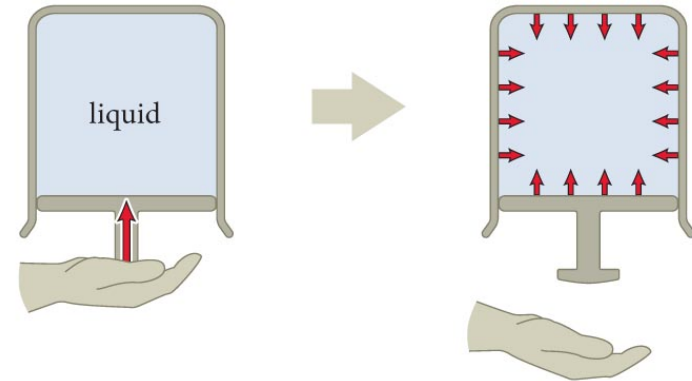

(b) Gases expand to fill any volume and therefore cannot sustain negative pressures

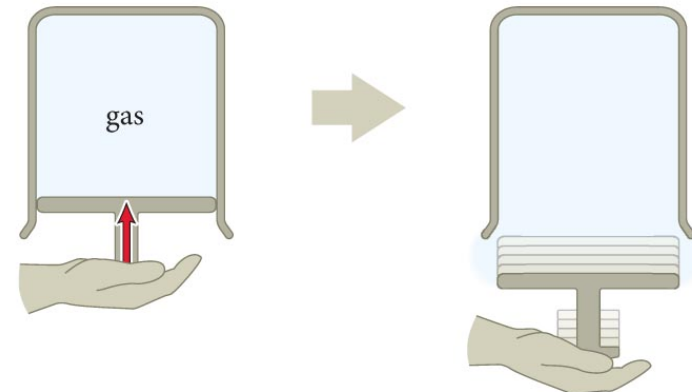

Checkpoint 18.2

 **18.2** Consider a plastic cup full of water. (a) Is the water exerting a force on the bottom of the cup? (b) On the sides of the cup? (c) Is the water pressure negative, zero, or positive?

- a) Yes – the water is at rest, and something must be balancing its weight
- b) Yes – if the cup weren't there, the water would move radially outward
- c) Positive – because water pushes outward, surfaces have to push inward, which puts it under compression. Compression means positive pressure

Section 18.1: Forces in a fluid

- Consider the water-filled tube shown in the figure. With no force exerted on the top piston, the water is subject to only two forces:
 1. Downward force of gravity
 2. Upward force of equal magnitude exerted by the bottom piston.
- The pressure at the top of the water is zero.
- The pressure at the bottom of the tube is nonzero due to the gravitational force.

(a) You must exert upward force on bottom piston to keep water from falling out

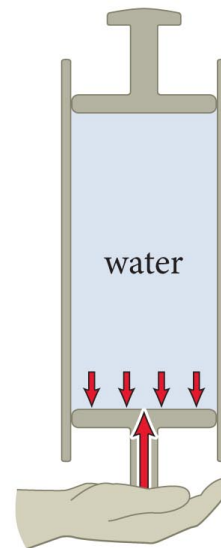

(b) Free-body diagram for water

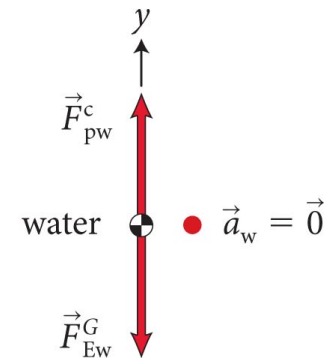

Section 18.1: Forces in a fluid

- Now imagine dividing a liquid in a container into two equal parts.
- We see from the free-body diagrams that the pressure at the bottom of the container is greater than the pressure at the center.

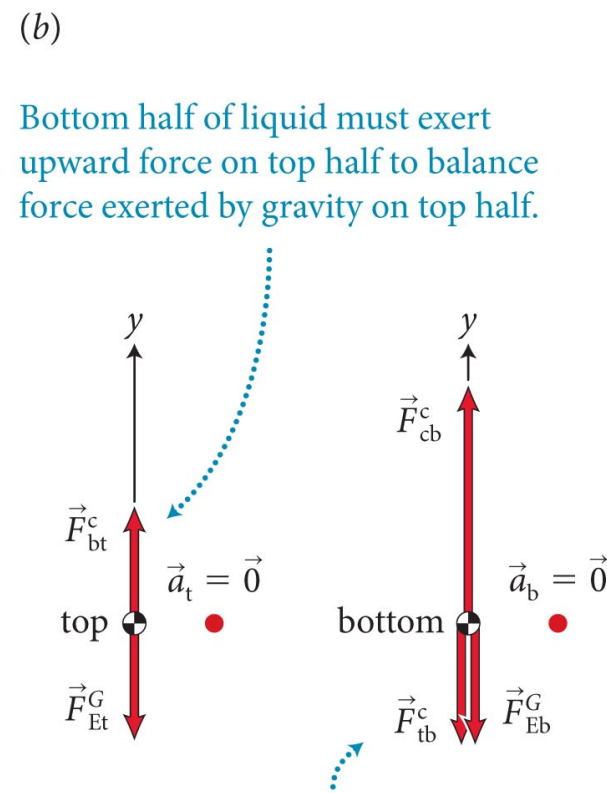
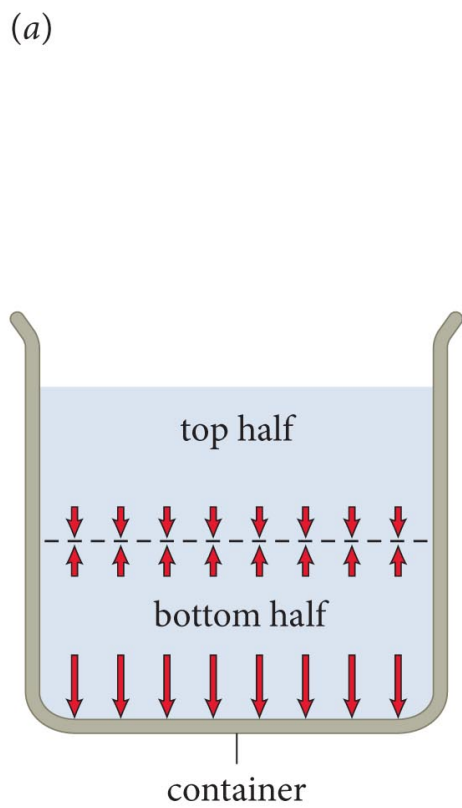

Therefore, top half exerts downward contact force on bottom half.

Section 18.1: Forces in a fluid

- What if you took away the top half?
- Bottom then has half the pressure

- Does it matter what the shape is?
No – only gravity is important, so only depth matters

- Pressure is just due to weight of the water above, which means it increases linearly with depth

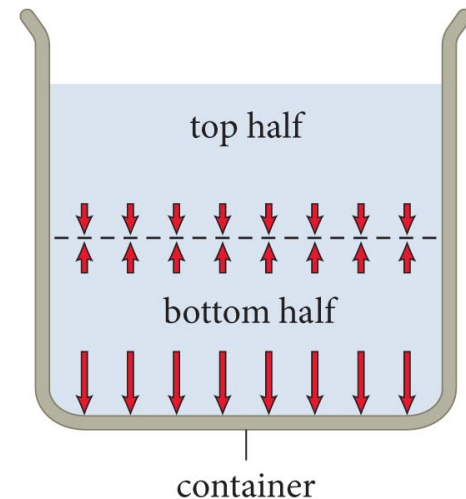

Section 18.1: Forces in a fluid

- This leads us to an important conclusion:
 - **The pressure in a liquid at rest in a container decreases linearly with height, regardless of the shape of the container.**
- We saw previously that any force exerted at one point in a liquid is transmitted to any other part of the liquid.
- This leads us to **Pascal's principle**:
 - **A pressure change applied to an enclosed liquid is transmitted undiminished to every part of the liquid and to the wall of the container in contact with the liquid.**

Section 18.1: Forces in a fluid

Example 18.1 Water and air pressure

Consider a cylindrical container that has a radius of 30.0 mm and is filled with water to a height of 0.150 m. If the container is at sea level, what is the pressure (*a*) at the water surface and (*b*) at the bottom of the container? (*c*) How far above the water surface is the decrease in atmospheric pressure the same as the pressure decrease between the bottom and top of the water? The mass densities of air and water are 1.20 kg/m^3 and $1.00 \times 10^3 \text{ kg/m}^3$, respectively.

Section 18.1: Forces in a fluid

Example 18.1 Water and air pressure (cont.)

1 GETTING STARTED I begin by making a sketch of the situation (Figure 18.8a). The problem deals with the pressure at three locations: at the bottom of the container (point A), at the water surface (B), and at some location above the surface (C). Because 0.150 m is a negligible distance in the context of this problem, the pressure at B is essentially equal to the atmospheric pressure at sea level.

(a)

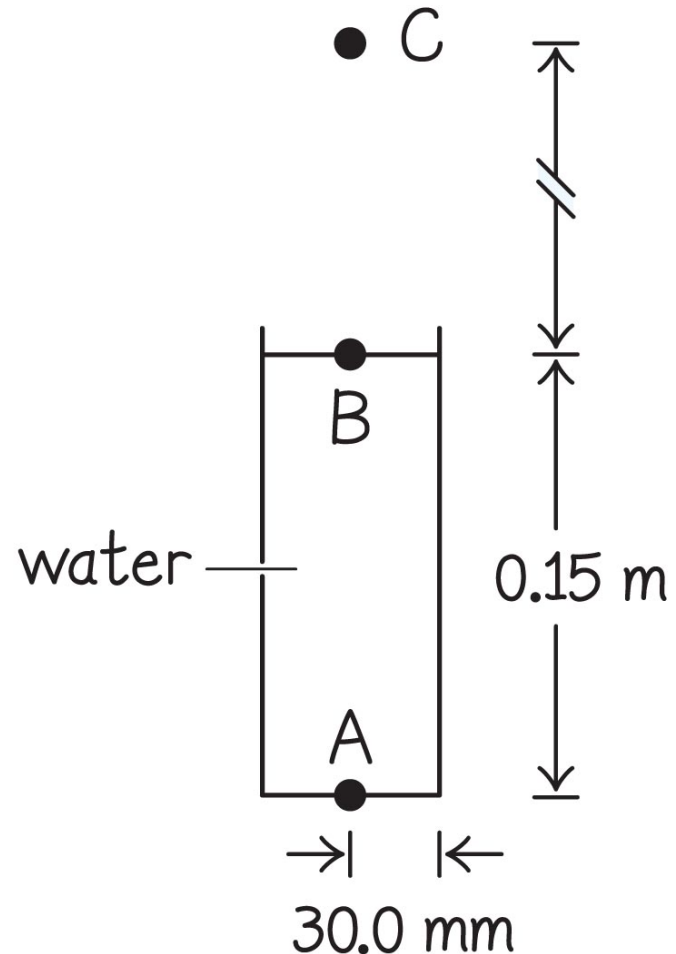

Section 18.1: Forces in a fluid

Example 18.1 Water and air pressure (cont.)

1 GETTING STARTED At A the pressure should be greater than at B because of the force of gravity exerted on the water. At C the pressure should be smaller than at B because the volume of air above C pressing down on C is smaller than the volume of air above B pressing down on B.

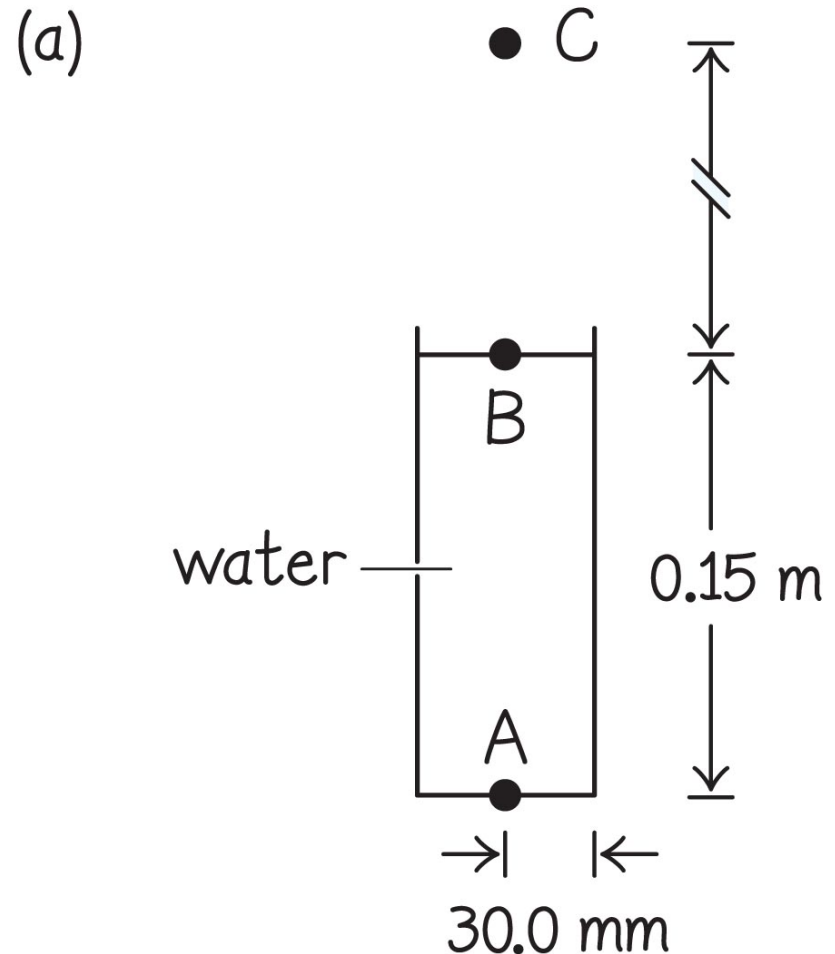

Section 18.1: Forces in a fluid

Example 18.1 Water and air pressure (cont.)

② **DEVISE PLAN** The pressure at A is equal to the magnitude of the force \vec{F}_{cw}^c exerted by the container bottom on the water divided by the area of the container bottom. To determine the magnitude of this force, I make a free-body diagram for the water (Figure 18.8b). The forces exerted on the water are the force of gravity \vec{F}_{Ew}^G , the downward force \vec{F}_{aw}^c exerted by the atmosphere, and the upward force exerted by the container bottom, which I need to determine.

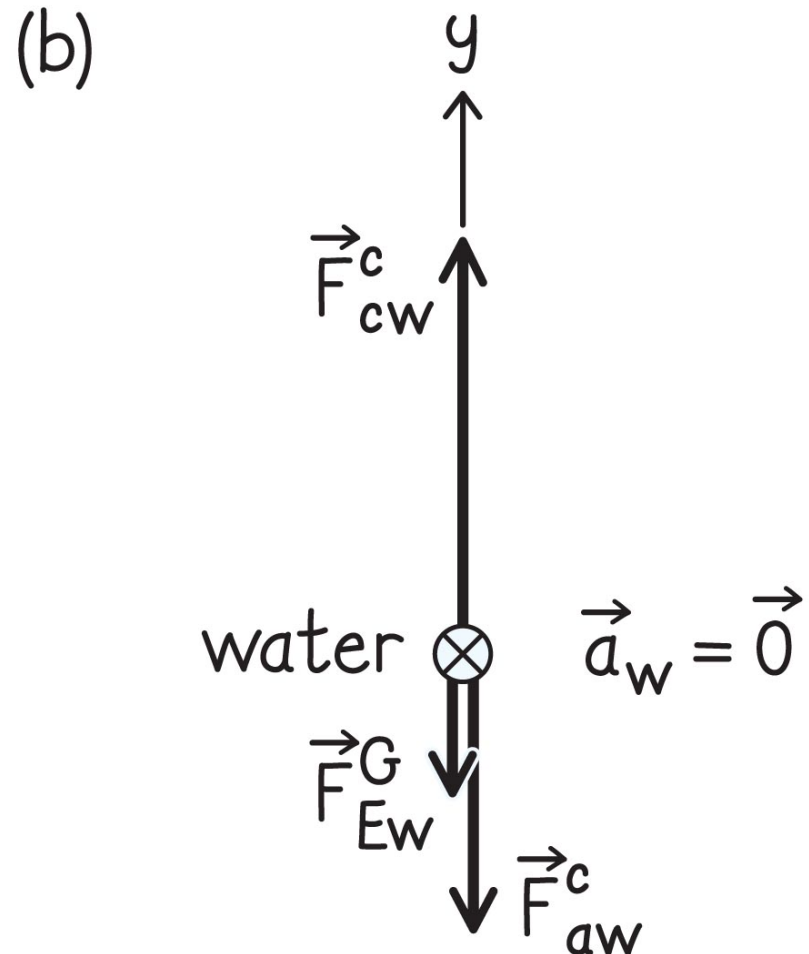

Section 18.1: Forces in a fluid

Example 18.1 Water and air pressure (cont.)

② DEVISE PLAN Because the water is at rest, the vector sum of these forces must be zero, and so the magnitude of the force exerted by the container bottom on the water is $F_{cw}^c = F_{Ew}^G + F_{aw}^c$. The force F_{aw}^c is determined by atmospheric pressure. To calculate F_{Ew}^G I need to know the mass of the water, which I can obtain by multiplying the volume of the water by the mass density of water.

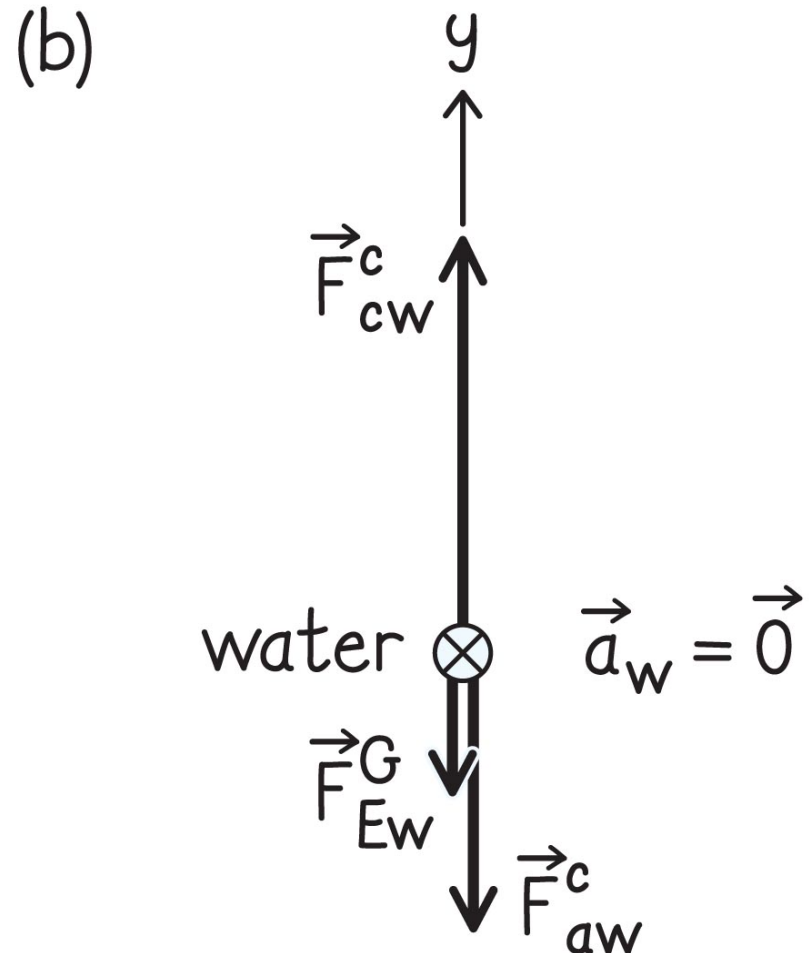

Section 18.1: Forces in a fluid

Example 18.1 Water and air pressure (cont.)

② DEVISE PLAN Because the difference in pressure between A and B is the same as that between B and C, I know that the mass of the air column between B and C must be equal to the mass of the water column between A and B.

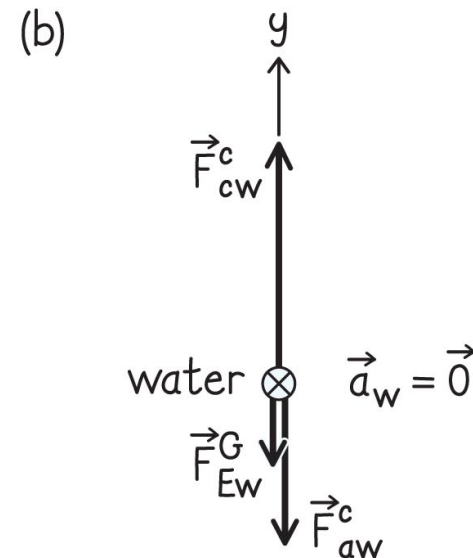
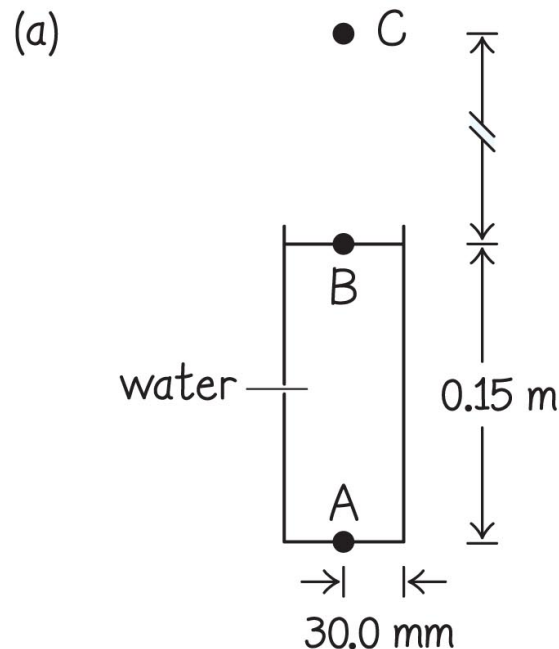

Section 18.1: Forces in a fluid

Example 18.1 Water and air pressure (cont.)

② DEVISE PLAN The ratio of the distances between these locations must therefore be equal to the ratio of the volumes, which is equal to the inverse of the ratio of the mass densities (assuming that the density of air is approximately constant over that column of air).

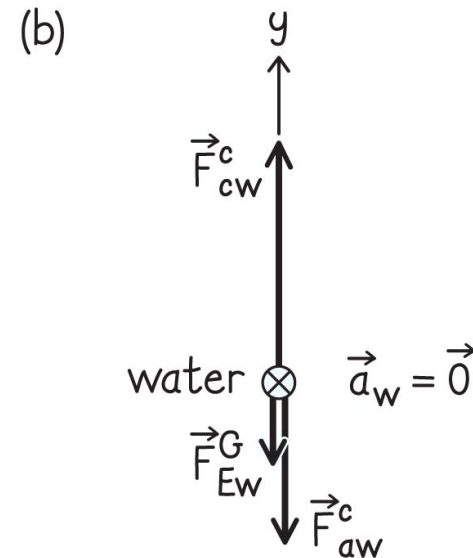
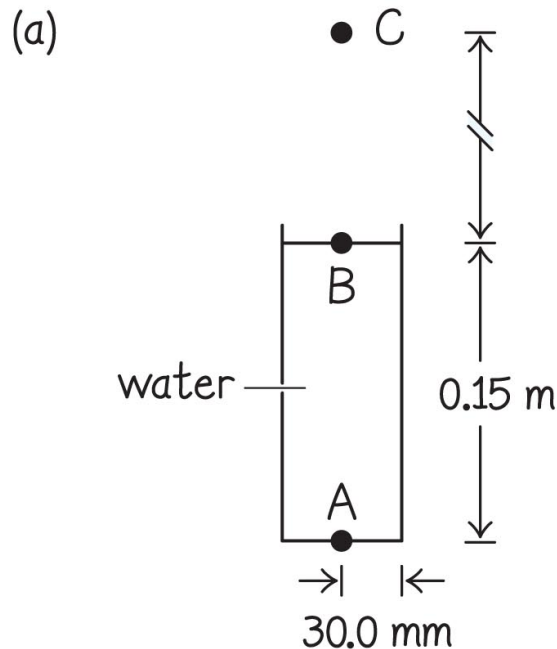

Section 18.1: Forces in a fluid

Example 18.1 Water and air pressure (cont.)

③ EXECUTE PLAN (*a*) The pressure at B is essentially equal to atmospheric pressure at sea level, which I can look up: $P_B = 1.01325 \times 10^5 \text{ N/m}^2$. ✓

Section 18.1: Forces in a fluid

Example 18.1 Water and air pressure (cont.)

3 EXECUTE PLAN (*b*) Dividing both sides of $F_{\text{cw}}^{\text{c}} = F_{\text{Ew}}^{\text{G}} + F_{\text{aw}}^{\text{c}}$ by the bottom surface area A , I get $P_{\text{A}} = F_{\text{Ew}}^{\text{G}}/A + P_{\text{atm}}$ because $P_{\text{A}} = F_{\text{cw}}^{\text{c}}/A$ and $P_{\text{atm}} = P_{\text{B}} = F_{\text{aw}}^{\text{c}}/A$.

The volume of the water is $V = Ah$, and so the mass of the water is this volume times the mass density of water: $m_{\text{water}} = Ah\rho$. The magnitude of the force of gravity exerted on the water is $F_{\text{Ew}}^{\text{G}} = m_{\text{water}}g = Ah\rho g$, and this force is exerted over the bottom surface area A of the container.

Section 18.1: Forces in a fluid

Example 18.1 Water and air pressure (cont.)

3 EXECUTE PLAN The pressure at point A is thus

$$P_A = \frac{F_{EW}^G}{A} + P_{\text{atm}} = \frac{Ah\rho g}{A} + P_{\text{atm}} = h\rho g + P_{\text{atm}}$$

$$= (0.150 \text{ m})(1.0 \times 10^3 \text{ kg/m}^3)(9.8 \text{ m/s}^2)$$

$$+ 1.01325 \times 10^5 \text{ N/m}^2 = 1.03 \times 10^5 \text{ N/m}^2. \checkmark$$

Section 18.1: Forces in a fluid

Example 18.1 Water and air pressure (cont.)

③ EXECUTE PLAN (c) The ratio of the distances is

$$\frac{\overline{AB}}{\overline{BC}} = \rho_{\text{air}}/\rho_{\text{water}} = (1.20 \text{ kg/m}^3)/(1.00 \times 10^3 \text{ kg/m}^3) = 1.20 \times 10^{-3}.$$

I am given that $\overline{AB} = 0.150 \text{ m}$, so $\overline{BC} = (0.150 \text{ m})/(1.20 \times 10^{-3}) = 1.25 \times 10^2 \text{ m}$. ✓

Section 18.1: Forces in a fluid

Example 18.1 Water and air pressure (cont.)

4 EVALUATE RESULT The answer I obtained in part *b* shows that the pressure difference between the top and bottom of the container is very small. That makes sense—I know from experience that my ears, which are very sensitive to pressure, don't experience any pressure difference when I swim a mere 0.15 m under the surface of water.

Section 18.1: Forces in a fluid

Example 18.1 Water and air pressure (cont.)

④ EVALUATE RESULT The answer to part *c* tells me that the distance above sea level I would have to climb in order to obtain the same pressure difference is about three orders of magnitude greater than the distance from B to A (0.15 m versus 120 m). This is consistent with the density of water being three orders of magnitude greater than that of air.

Again, I know from experience that I don't experience any detectable pressure difference when going up 120 m in air, so my answer is not unreasonable.

Section 18.1

Question 1

How does a pressure change applied to the top of a column of liquid held in a closed container affect the pressure throughout the liquid?

1. It does not affect it since the pressure in the fluid is due to the fluid only.
2. It increases the pressure only at the air/liquid interface.
3. It increases the pressure throughout the fluid.
4. It decreases the pressure throughout the fluid.

Section 18.1

Question 1

How does a pressure change applied to the top of a column of liquid held in a closed container affect the pressure throughout the liquid?

1. It does not affect it since the pressure in the fluid is due to the fluid only.
2. It increases the pressure only at the air/liquid interface.
-  3. It increases the pressure throughout the fluid.
4. It decreases the pressure throughout the fluid.

Section 18.2: Buoyancy

Section Goals

You will learn to

- Apply the concept of pressure in order to define buoyancy.
- Derive Archimedes' principle from the depth variation of pressure in a fluid.

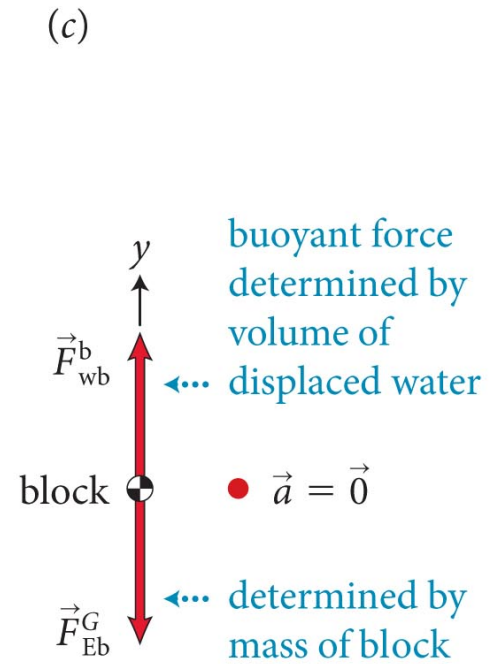
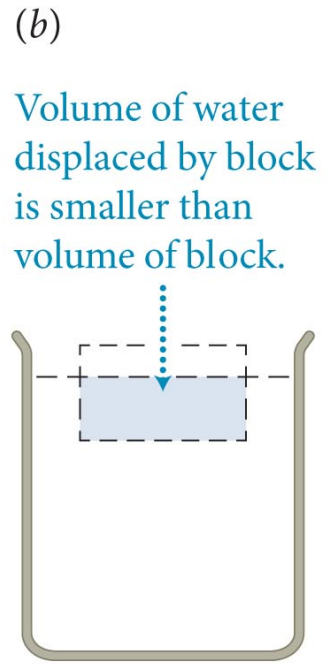
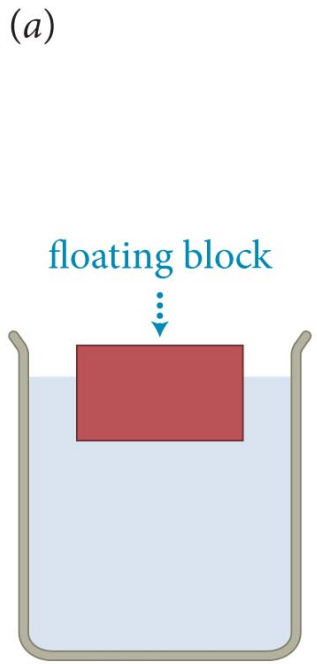

Section 18.2: Buoyancy

- Consider a brick submerged in a liquid, as illustrated.
- The pressure in the liquid increases with depth.
- The top and bottom surfaces of the brick have equal area, so $F_{wb}^c > F_{wt}^c$.
- Therefore, the pressure in the liquid exerts a *net upward force* on the brick. This is the **buoyant force**.

(a) Brick held under water

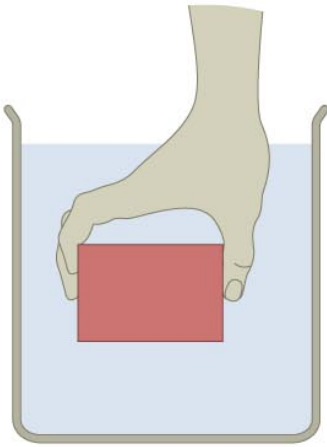

(b) Free-body diagram that separates force exerted by water on brick's top and bottom surfaces

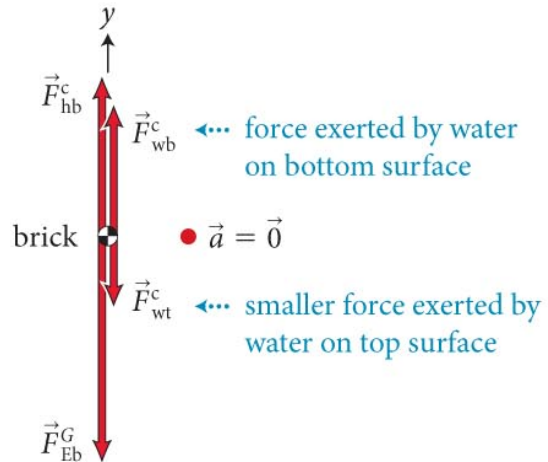

(c) Free-body diagram showing buoyant force exerted by water on brick

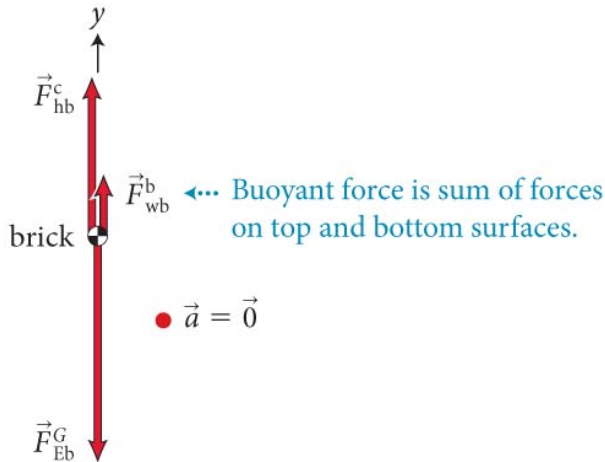

Checkpoint 18.5



18.5 (a) What happens to the pressure difference between the top and bottom of the brick in Figure 18.9a when the brick is held deeper in the water? (b) What happens to the pressure difference when the pressure at the surface of the water is increased? (c) What is the effect of the pressure in the water on the vertical sides of the brick? (d) Consider the same brick held in the air. Does the air exert a buoyant force on the brick? If so, in which direction is this force?

(a) Brick held under water

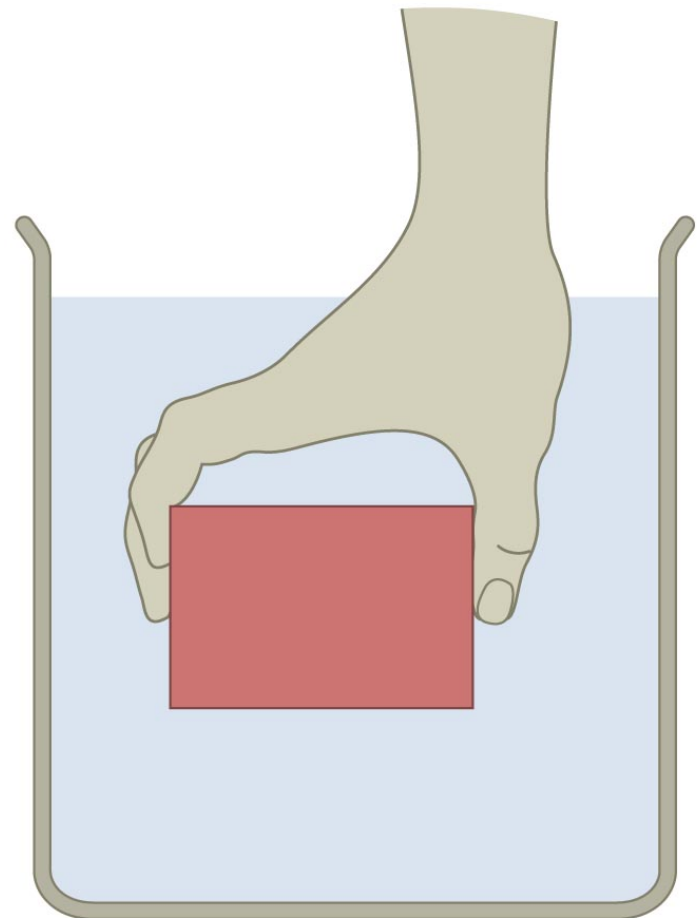

Checkpoint 18.5

- a) Nothing – since pressure increases linearly with depth, the *difference* between top and bottom is always the same
- b) Nothing – the pressure change applied is transmitted undiminished to every part of the fluid, so the top and bottom change by the same amount
- c) No effect, pressure on the sides causes equal and opposite forces
- d) Yes – the pressure in the atmosphere also decreases with height, though less than in water. The force is also upward.

Section 18.2: Buoyancy

- When an object is submerged in a fluid, it displaces fluid.
- The displaced fluid's volume equals the volume of the portion of the object that is immersed in the fluid.
- From the free-body diagram for the displaced water, we can see that $F_{\text{wv}}^{\text{b}} = F_{\text{Ev}}^{\text{G}}$.

(a) Submerged object

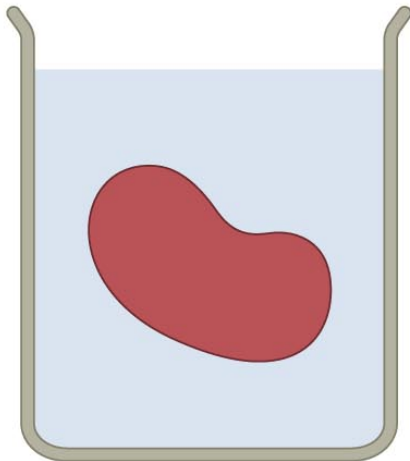

(b) We replace object with water it displaces

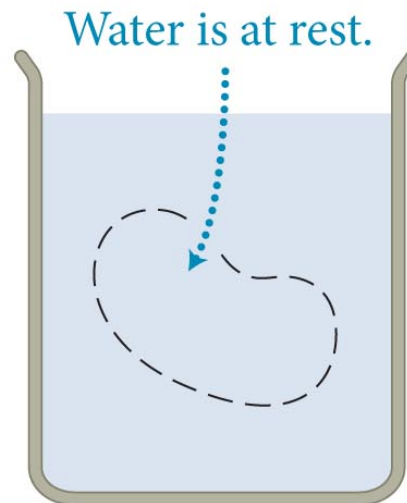

(c) Free-body diagram for displaced water

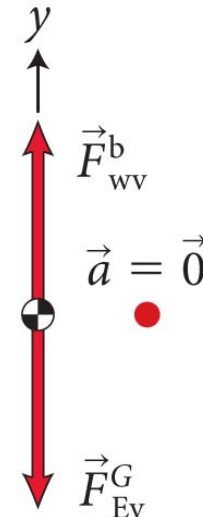

Section 18.2: Buoyancy

- The object feels a net force that is the difference between its weight and the weight of the water it displaced
- This gives us a way of determining the buoyant force exerted on an object:
 - **An object submerged either fully or partially in a fluid experiences an upward buoyant force equal in magnitude to the force of gravity on the fluid displaced by the object.**
 - **The volume of the displaced fluid is equal to the volume of the submerged portion of the object.**
 - This statement is called **Archimedes' principle**.

Checkpoint 18.6



18.6 If the buoyant force exerted on an object is always equal in magnitude to the force of gravity exerted on the fluid displaced by the object, why does a brick placed in a barrel of water sink?

The density of the brick is greater than that of water.

The buoyant force is $m_{water}g$, but the brick's weight is $m_{brick}g$, and $m_{brick}g > m_{water}g$

Section 18.2: Buoyancy

- If an object is only partially submerged in a fluid as illustrated, we can use the displaced volume of the fluid to determine the buoyant force.

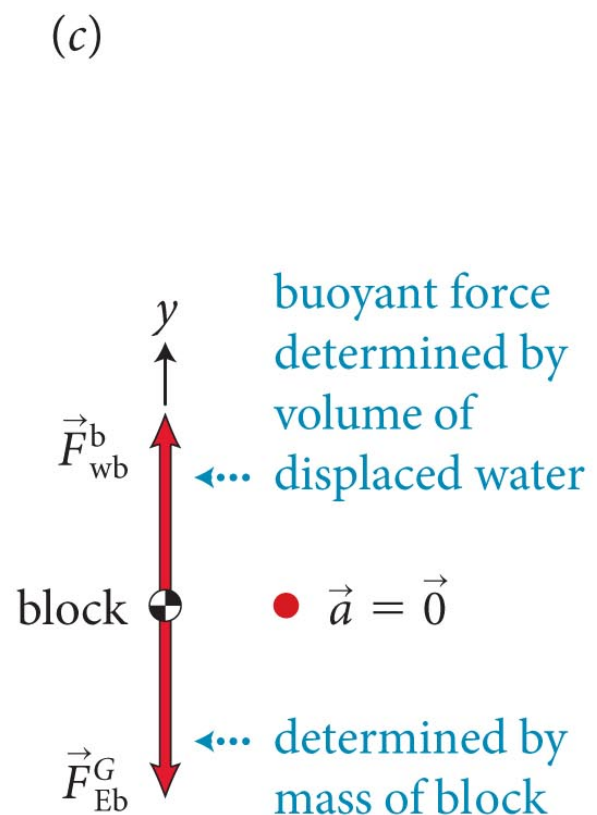
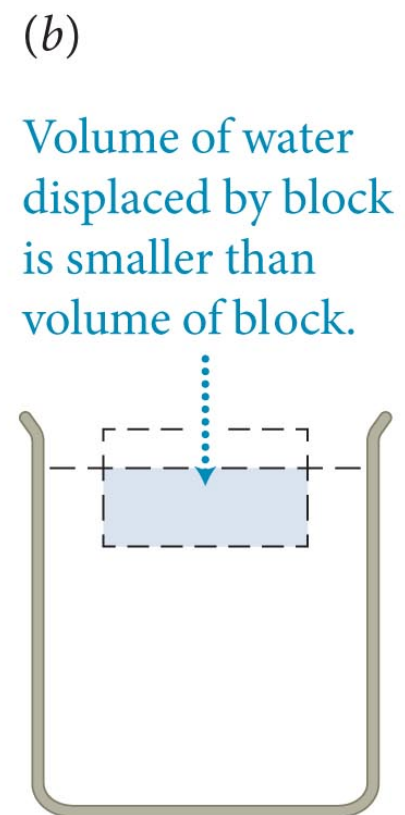
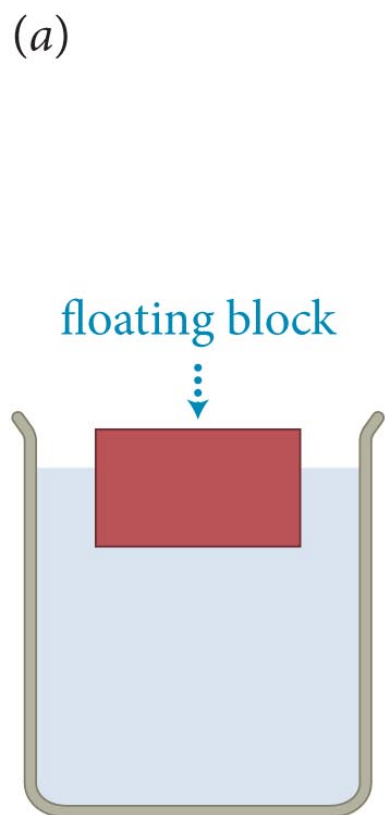

Section 18.2: Buoyancy

- Now we can explain how materials that normally sink can be made to float.
- This can be achieved by designing the object (say a steel ship) in such a way to ensure that the volume of water displaced is great enough to offset the force of gravity.

steel hull (cross section)

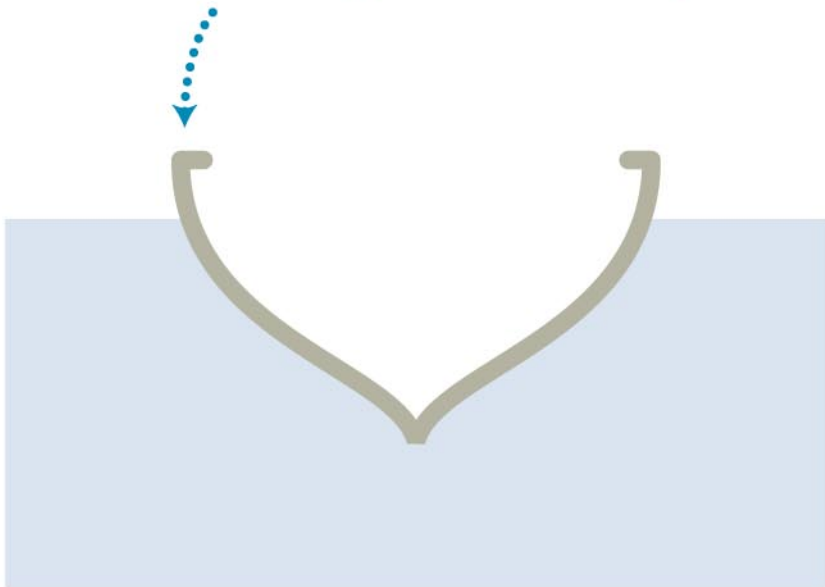

Volume of water displaced by hull exceeds volume of steel.

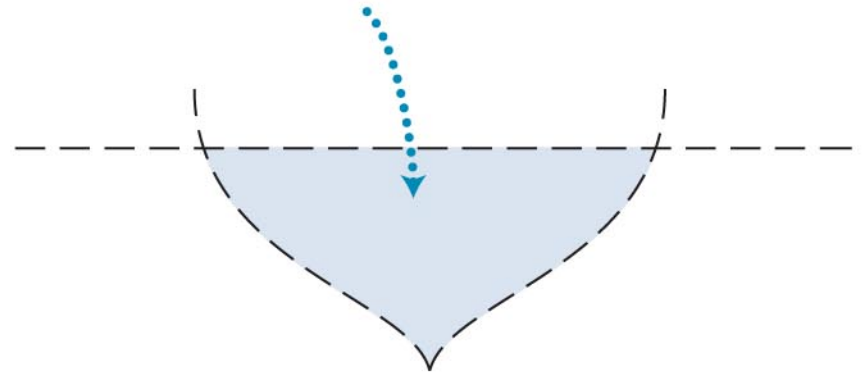

Checkpoint 18.7

 **18.7** A pan with a rock in it is floating in water. Suppose you remove the rock and use a very lightweight string to suspend it from the bottom of the pan (Figure 18.14). If the combination still floats, is the volume of water displaced when the rock is suspended greater than, equal to, or smaller than the volume of water displaced when the rock is in the pan?

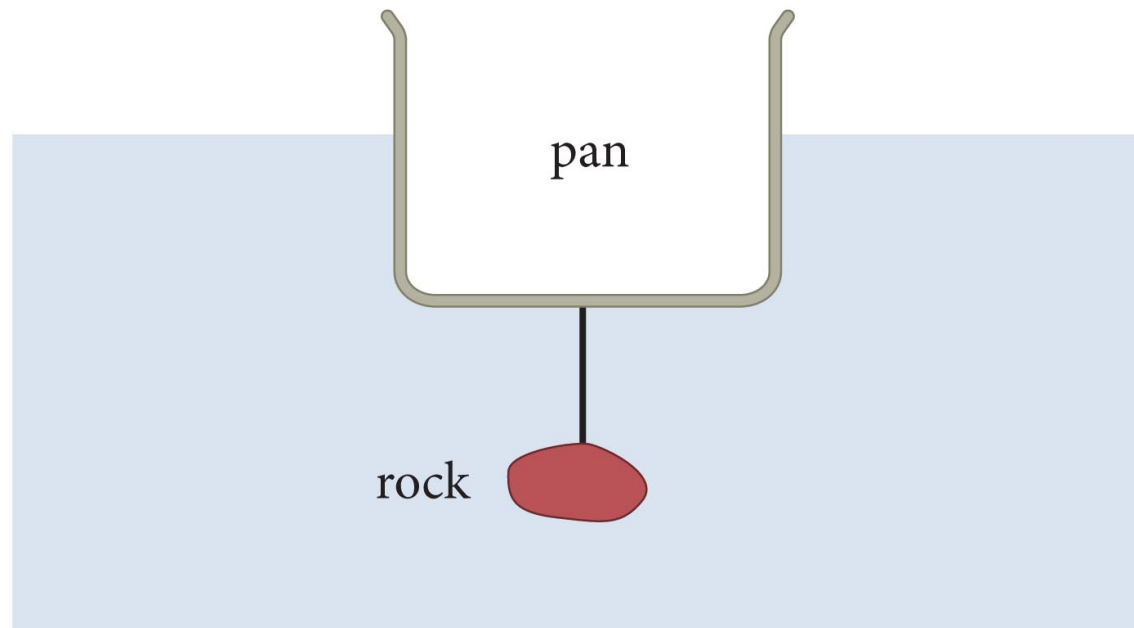

Checkpoint 18.7

- Equal.
- The pan-rock combination floats in both cases due to the buoyant force. In both cases it must be equal to the force of gravity exerted on the displaced water.
- The buoyant force must also equal the weight of the combination since it remains at rest.
- The mass doesn't change when you rearrange the combination, so the volume of water displaced doesn't change either

Section 18.2

Question 2

Imagine holding two bricks under water. Brick A is just beneath the surface of the water, while brick B is at a greater depth. The force needed to hold brick B in place is

1. larger than
2. the same as
3. smaller than

the force required to hold brick A in place.

Section 18.2

Question 2

Imagine holding two bricks under water. Brick A is just beneath the surface of the water, while brick B is at a greater depth. The force needed to hold brick B in place is

1. larger than
- ✓ 2. the same as
3. smaller than

the force required to hold brick A in place.

Section 18.3: Fluid flow

Section Goals

You will learn to

- Contrast **laminar and turbulent** flow.
- Model the **flow of incompressible fluids** in pipes.
- Recognize some consequences of the **Bernoulli effect**.

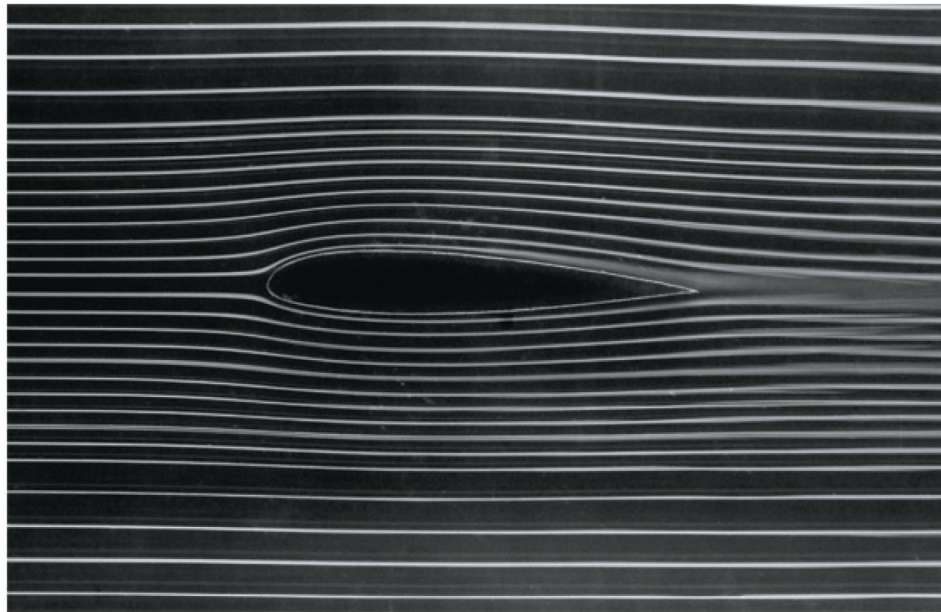

Section 18.3: Fluid flow

- *Fluid flow* where the velocity of the fluid at any given location is constant is said to be **laminar**.
- The lines drawn to represent the paths taken by any particle in a fluid flow are called **streamlines**.
- Streamlines can be made visible by injecting smoke into the flow of gas or ink into the flow of liquids.



Section 18.3: Fluid flow

- In laminar flow, the streamlines maintain their shapes and position.
- In **turbulent flow**, streamlines are erratic and often curl into *vortices*.
- Whether a flow of a fluid past a stationary object is laminar or turbulent depends on
 1. the speed of the flow
 2. the shape of the object, and
 3. the fluid's resistance to shear stress (its *viscosity*).

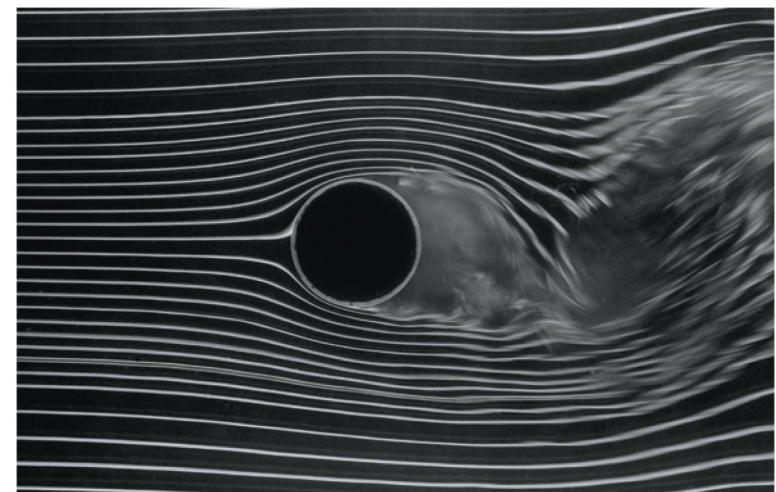
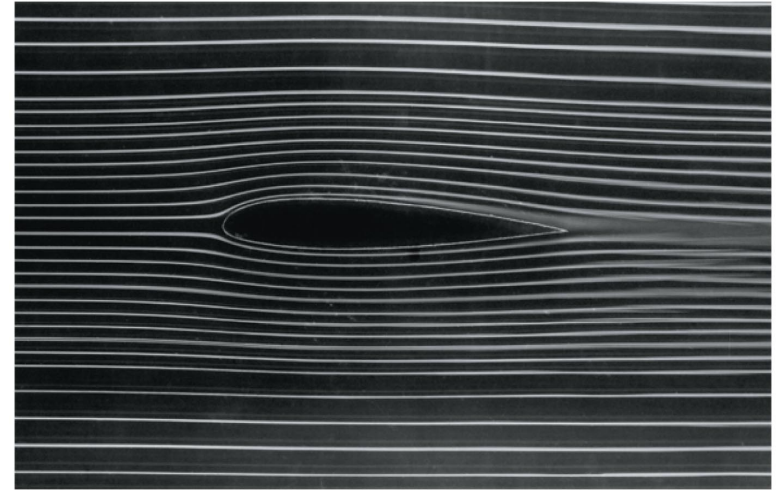

Section 18.3: Fluid flow

- The figure illustrates how fluid flow is affected by the fluid's speed viscosity and the shape of object.

(a) Low flow speed, zero viscosity

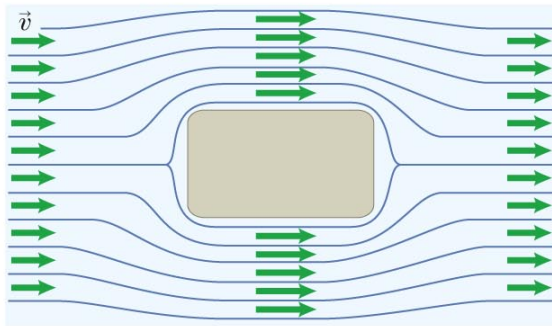

(b) Low flow speed, nonzero viscosity

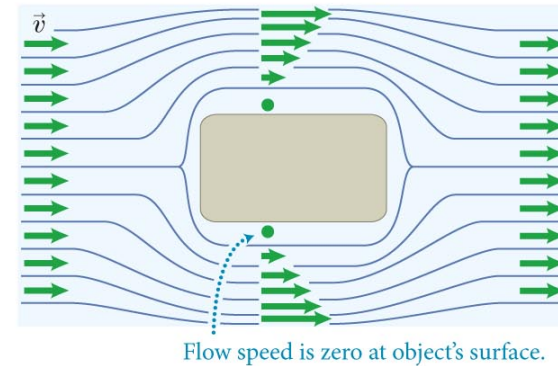

(c) High flow speed, turbulence

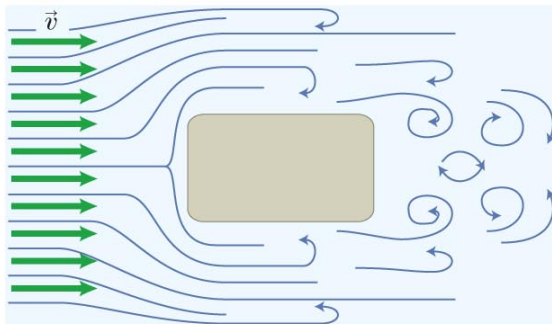

(d) High flow speed, streamlined object

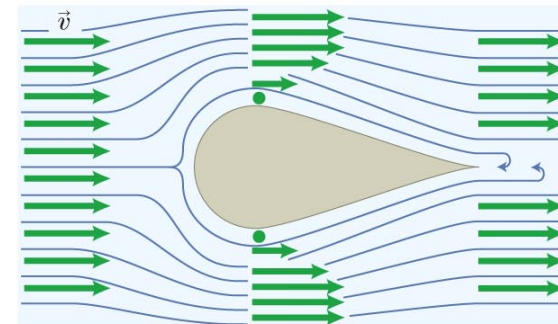

Checkpoint 18.8

 **18.8** Instead of laminar fluid flow past a stationary object as in Figure 18.18*a*, consider the motion of an object moving at constant velocity through a stationary fluid. Do you expect the flow pattern surrounding the object to be the same as in Figure 18.18*a* or different?

(*a*) Low flow speed, zero viscosity

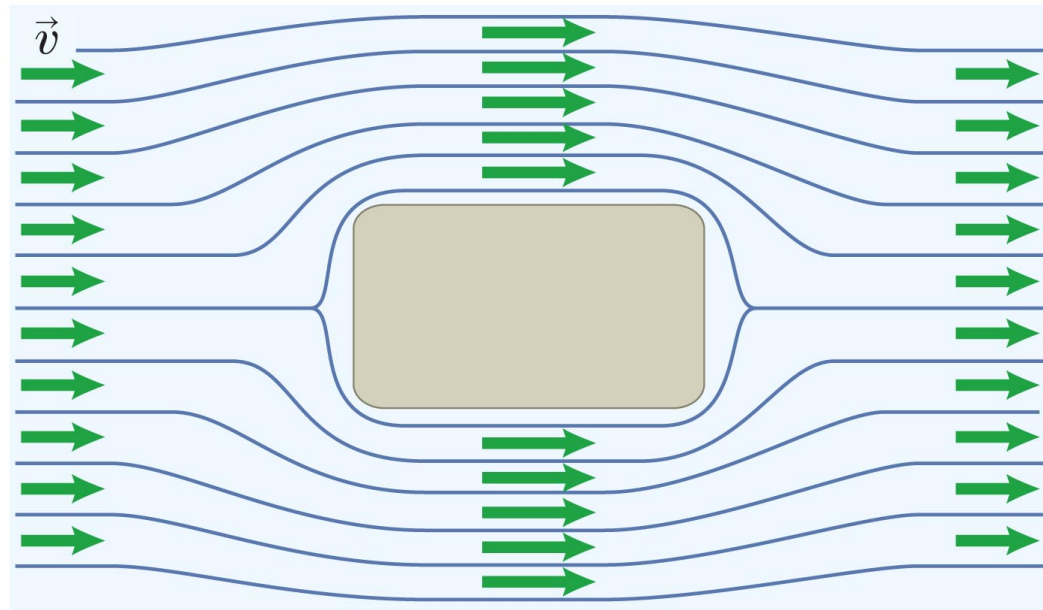

Checkpoint 18.8

- The same – only the *relative* velocity matters.
- Would it matter if you viewed the situation from the ground or sitting on top of the object?

Section 18.3: Fluid flow

- Fluid flowing through a pipe of fixed diameter.
- The figure illustrates how the viscosity of the fluid affects the flow speed pattern.
- Note the *boundary layer* for viscous fluids!
 - Look at your ceiling fan, most dirt on leading edge

(a) Nonviscous fluid

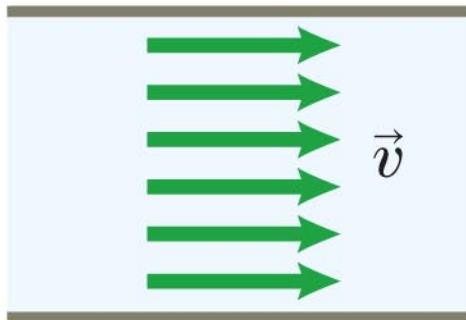

(b) Viscous fluid at low speed

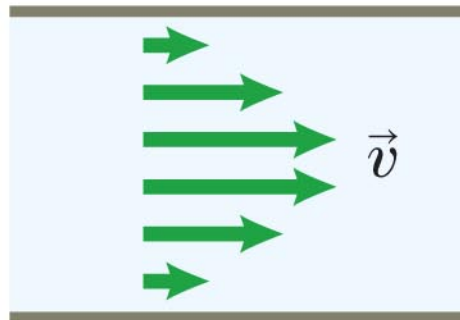

(c) Viscous fluid at high speed

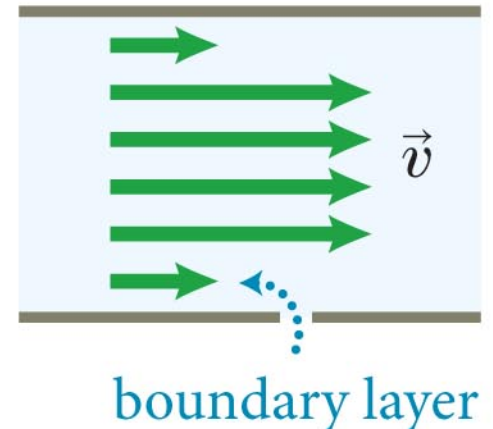

Section 18.3: Fluid flow

- Let us now consider flow through a constriction in a pipe.
- A flowing fluid speeds up when the region through which it flows narrows and slows down when the region widens.
- The density of streamlines reflects the changes in flow speed:
 - When streamlines in a laminar flow get closer together, the flow speed increases.
 - When they get farther apart, the flow speed decreases.

(a) When a pipe carrying a fluid narrows, the streamlines get closer together

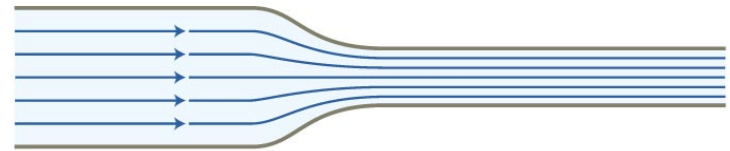

(b) Where the pipe is narrower, the fluid must flow faster

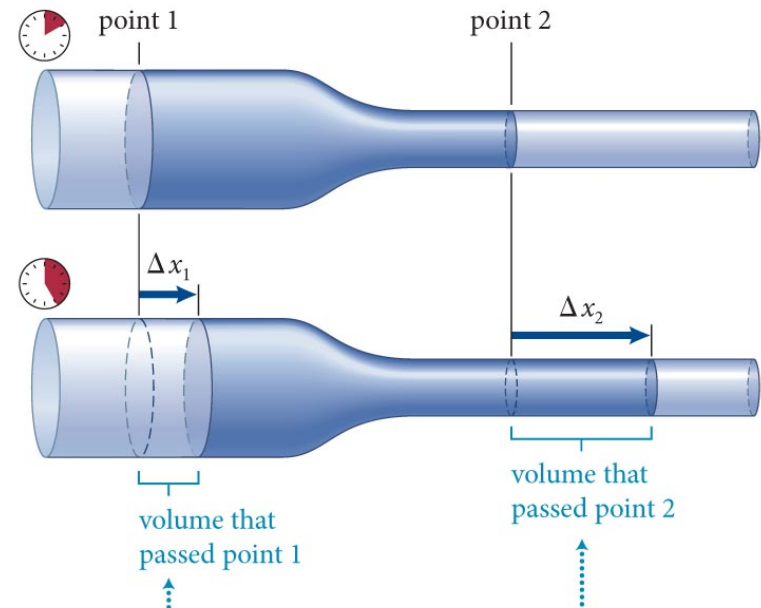

These volumes must be equal (what goes in must come out), so fluid must move faster where pipe is narrow.

Section 18.3: Fluid flow

- When the flow speed in a laminar flow increases, the pressure in the fluid decreases.
- This effect is called the *Bernoulli effect*.
- One familiar example of the Bernoulli effect is the curved motion of a rapidly moving spinning ball.
 - OMG finally MLB
- The figure shows the top view of a curveball.

(b)

Reference frame moving with ball

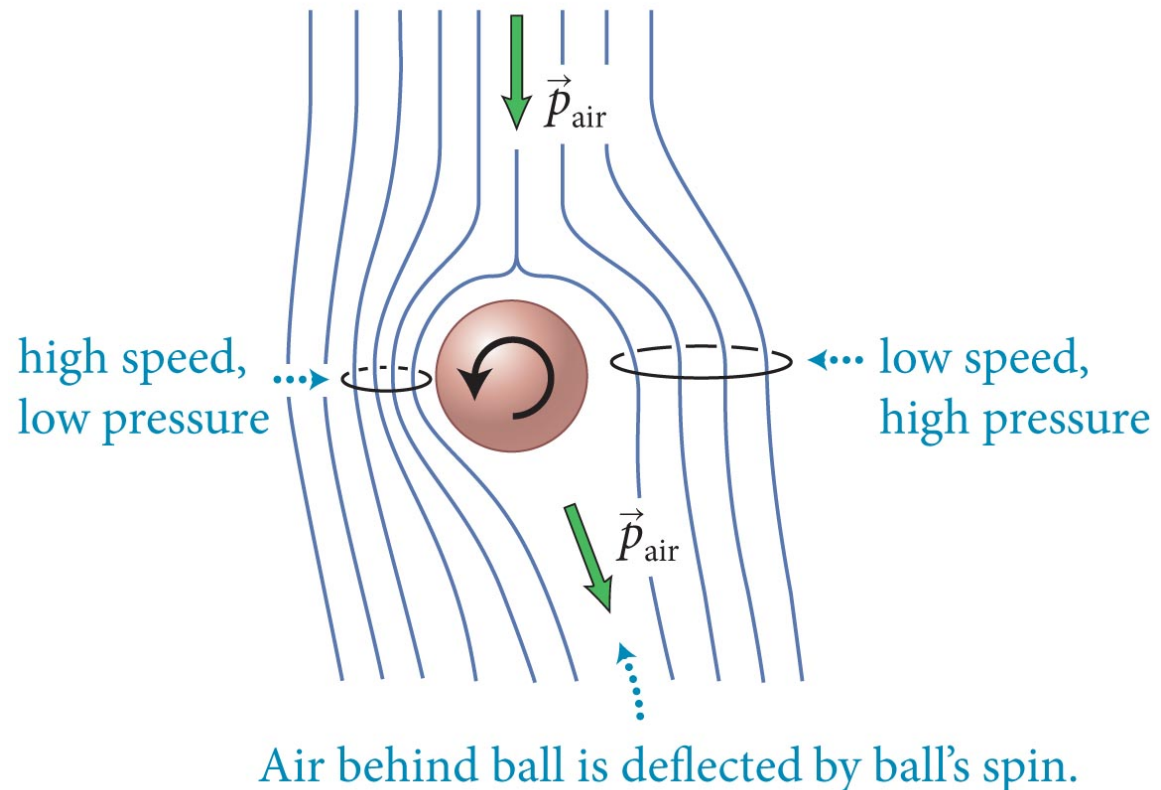

Section 18.3: Fluid flow

Example 18.3 Magic pull

When air is blown downward into the narrow opening of a funnel (Figure 18.22), a lightweight ball initially positioned below the wide opening is pulled up into the funnel and held in place. Explain how the ball can be pulled upward even though the airflow and gravity are both directed downward.

When air blows →
into funnel . . .

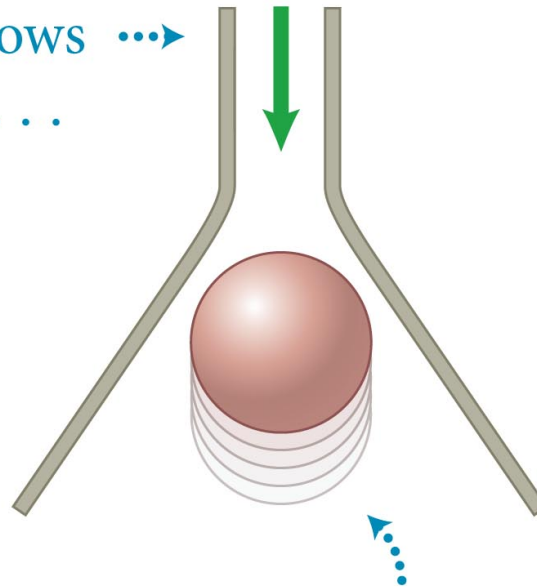

. . . ball is pulled *upward* into funnel.

Section 18.3: Fluid flow

Example 18.3 Magic pull (cont.)

① GETTING STARTED I know that if I were to blow against the ball, it would move away from me. So I reason that to pull the ball upward, there must be exerted on it an upward force that is greater than the combined effect of the downward gravitational and airflow forces.

Section 18.3: Fluid flow

Example 18.3 Magic pull (cont.)

① GETTING STARTED The ball is subject to an upward buoyant force, but I know this force is smaller than that of gravity alone because a ball—even a lightweight one—does not float in air. So there must be an additional force pulling the ball upward. Because this force is absent when no air flows past the ball, that flow must be causing the upward force.

Section 18.3: Fluid flow

Example 18.3 Magic pull (cont.)

② **DEVISE PLAN** To understand the effects of the flowing air, I should sketch the streamlines (I assume laminar flow). The density of the streamlines tells me how the speed of the flow varies, and from this information I can determine how the air pressure varies around the ball, which in turn tells me in which direction the air exerts a force on the ball.

Section 18.3: Fluid flow

Example 18.3 Magic pull (cont.)

③ EXECUTE PLAN Figure 18.23 shows how the streamlines must bend around the ball. In order to pass around the ball, they must be squeezed together between the ball and the sides of the funnel. At the bottom of the funnel, the diameter of the funnel is very wide and so the streamlines are spaced far apart.

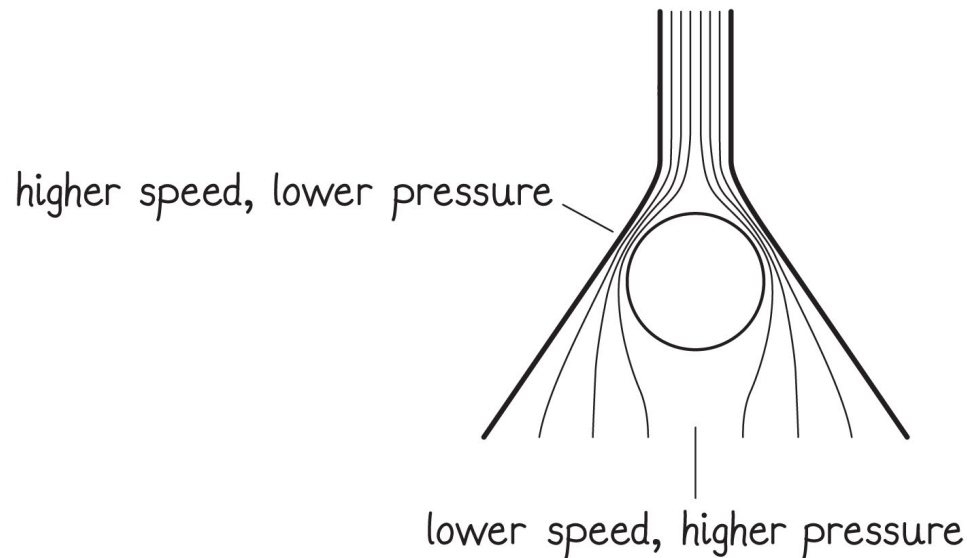

Section 18.3: Fluid flow

Example 18.3 Magic pull (cont.)

③ EXECUTE PLAN This tells me that the flow speed is smaller below the ball than above it and consequently that the pressure is greater below the ball than above it. This pressure difference causes an upward force on the ball. If the pressure difference is great enough, this force can exceed the combined effect of the force of gravity and the downward force of the airflow on the ball. ✓

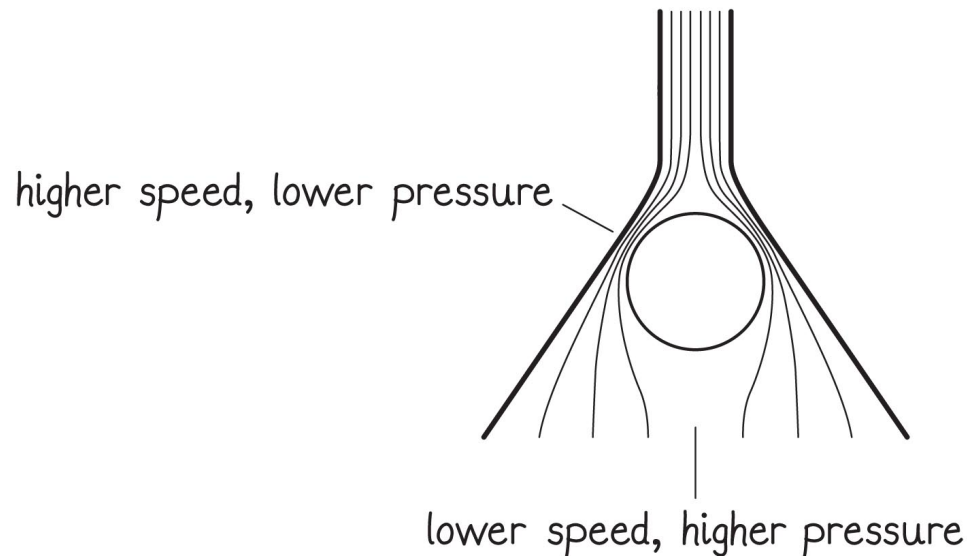

Section 18.3: Fluid flow

Example 18.3 Magic pull (cont.)

④ EVALUATE RESULT My answer is consistent with the observation given in the problem statement, even though the ball's being pulled *upward* by a downward flow of air seems nothing short of magic! I assumed the flow to be laminar, which may not be entirely correct for an object like a ball (which is not streamlined). However, because air is a gas and because gases have very low viscosity, the assumption that the flow remains laminar is not unreasonable.

Checkpoint 18.9



18.9 The cloth roof of a convertible car often bulges at high speed, even when the top fits tightly and no wind is getting caught under it. Explain what causes the bulging.

The streamlines that pass over the roof of the car get closer together, indicating higher flow speed and thus lower pressure just above the roof.

The air pressure in the car is unchanged, and is therefore greater than the pressure outside.

The pressure difference gives a net force outward, bulging the roof.

Section 18.3

Question 5

Blood flows through a coronary artery that is partially blocked by deposits along the artery wall. Through which part of the artery is the flux (volume of blood per unit time) largest?



1. The narrow part
2. The wide part
3. The flux is the same in both parts.

Section 18.3

Question 5

Blood flows through a coronary artery that is partially blocked by deposits along the artery wall. Through which part of the artery is the flux (volume of blood per unit time) largest?



1. The narrow part
2. The wide part
- ✓ 3. The flux is the same in both parts.

Section 18.3

Question 6

Blood flows through a coronary artery that is partially blocked by deposits along the artery wall. Through which part of the artery is the flow speed largest?



1. The narrow part.
2. The wide part.
3. The flux is the same in both parts.

Section 18.3

Question 6

Blood flows through a coronary artery that is partially blocked by deposits along the artery wall. Through which part of the artery is the flow speed largest?

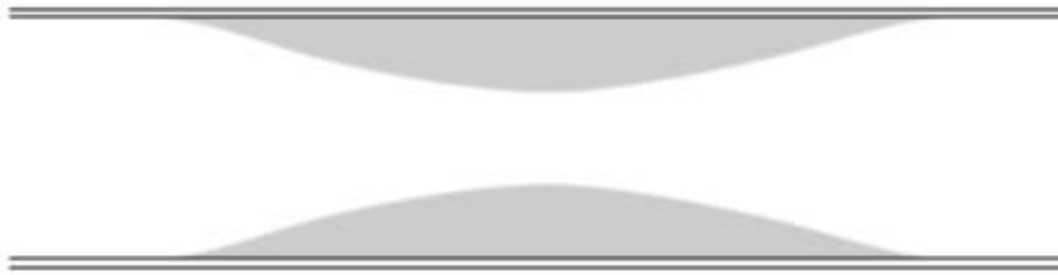

- ✓ 1. The narrow part.
- 2. The wide part.
- 3. The flux is the same in both parts.

Chapter 18: Self-Quiz #1

Masons use a hose open at both ends and filled with water to ensure that the blocks they lay remain level (Figure 18.37). How does such a hose help them do this?

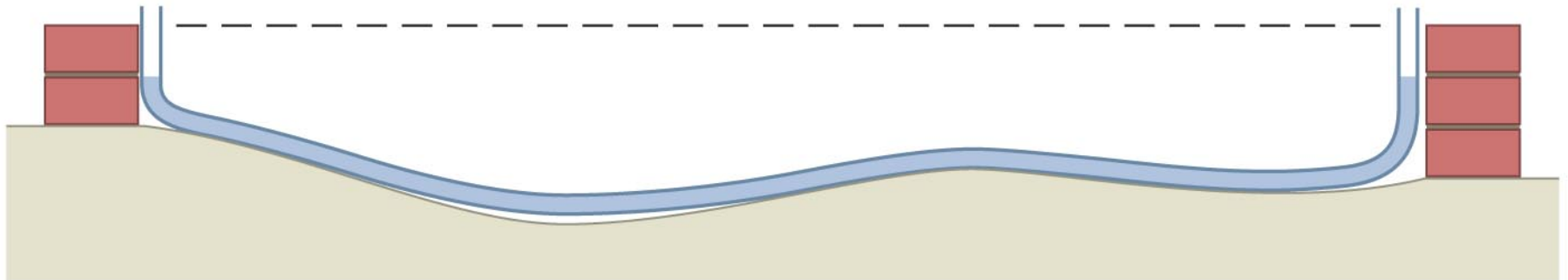

Chapter 18: Self-Quiz #1

Answer

The air pressure at both water surfaces is atmospheric pressure. Therefore the height of the water surface at the left end of the hose must be the same as the height of the water surface at the right end, in order to balance the pressure throughout the water. If the masons align the two ends of the hose with the two ends of a row of blocks and no water bubbles out of either end of the hose, the two ends of the wall are at the same height, meaning the row is level.

Chapter 18: Self-Quiz #3

For a thrown ball to rise, what type of spin should the thrower place on it?

Chapter 18: Self-Quiz #3

Answer

The thrower needs to place a “backspin” on the ball, which is a spin in which the top of the ball moves toward the thrower. This direction of spin causes the speed of the air relative to the surface of the ball to be greater at the top of the ball than at the bottom. Thus the air pressure is smaller at the top of the ball than at the bottom. As a result, the ball is subject to an upward force (Magnus force) due to this pressure difference.

Does it *actually* rise? No, the force is not big enough. But it falls less than the batter anticipates, so they interpret the motion as rising.

Chapter 18: Fluids

Quantitative Tools

Section 18.5: Pressure and gravity

- **Pressure** is defined as the ratio of the magnitude of the force to the area on which the force is exerted.

$$P \equiv \frac{F_{fs}^c}{A}$$

- The SI units of pressure are N/m^2 , also defined as the **pascal** (Pa), where $1 \text{ Pa} = 1 \text{ N/m}^2$.
- Because, 1 Pa is a very small pressure, we often use kilopascals (kPa).

Section 18.5: Pressure and gravity

- For an example, the average pressure of the atmosphere at sea level is

$$P_{\text{atm}} = 101.3 \text{ kPa}$$

- This pressure is referred to as 1 atmosphere (1 atm).

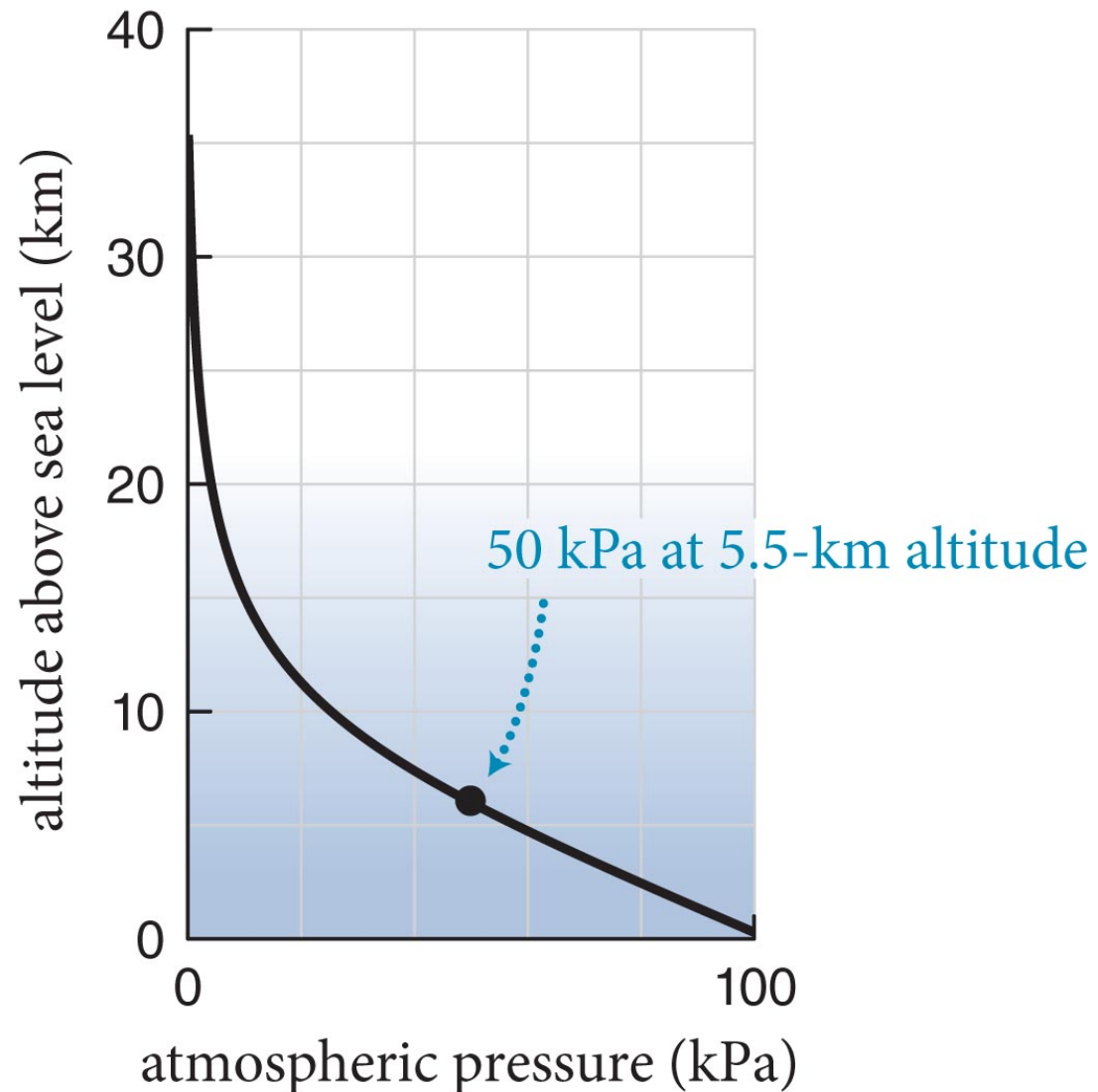

Checkpoint 18.13



18.13 Consider a book lying on a table at sea level with the front cover facing up. The book is 0.28 m tall, 0.22 m wide, and 50 mm thick; its mass is 3.0 kg. How does the force exerted by the atmosphere on the front cover compare with the force of gravity exerted on the book?

Checkpoint 18.13

- The force exerted by the air on the cover is

$$\begin{aligned}F_{ac}^c &= P_{atm}A = (101 \text{ kPa})(1000 \text{ Pa/1 kPa})(0.28\text{m})(0.22\text{m}) \\ &= 6200 \text{ N}\end{aligned}$$

- The force of gravity is

$$F_{Eb}^G = (3.0 \text{ kg})(9.8 \text{ m/s}^2) = 29 \text{ N}$$

- The force exerted by the atmosphere is about 200 times greater than the gravitational force

Checkpoint 18.14



18.14 A dart that has a suction cup at one end sticks to a ceiling. Describe what force holds the dart against the ceiling.

As the suction cup hits the ceiling, the bowl of the cup collapses, forcing out the air that was initially in the bowl. The pressure in the space between the cup and ceiling decreases, and is then lower than the atmosphere.

The air in the room then exerts an upward force greater than the downward force exerted by the air still inside the cup, which holds the dart up against the ceiling.

Section 18.5: Pressure and gravity

- The imaginary cylinder of liquid shown in the figure is at rest, and hence the vector sum of the three forces acting on it must be zero:

$$\begin{aligned}\sum F_{cy} &= F_{1cy}^c + F_{2cy}^c + F_{Ecy}^G \\ &= P_1 A - P_2 A - mg = 0\end{aligned}$$

(a) Imaginary cylindrical volume of liquid at rest inside larger volume of same liquid

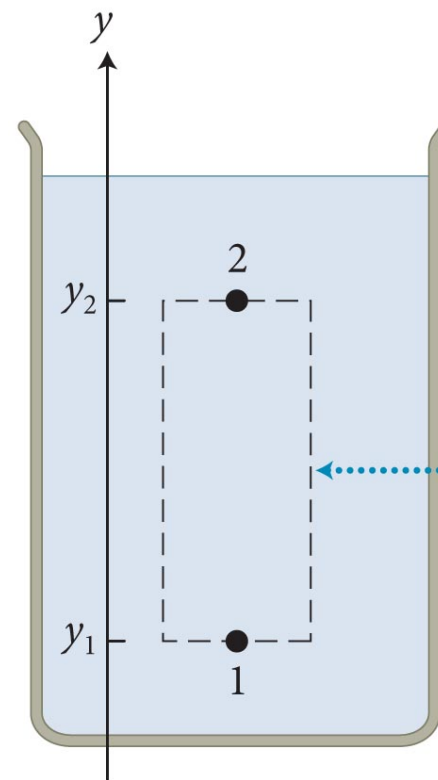

(b) Free-body diagram for cylinder

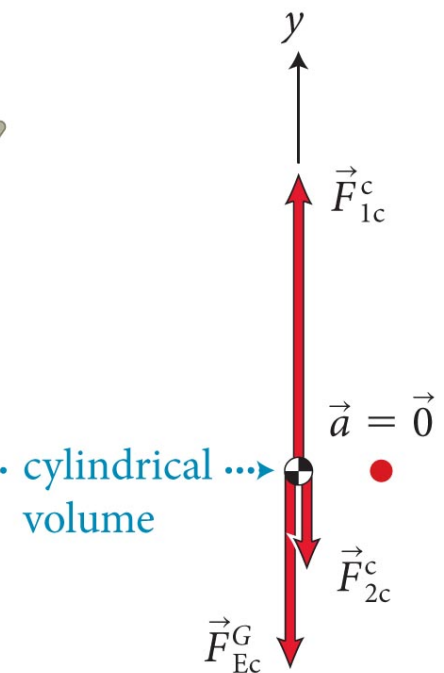

Section 18.5: Pressure and gravity

- The mass of the liquid in the cylindrical volume is

$$m = \rho V = \rho A(y_2 - y_1).$$

- Therefore, the pressure at all points in a horizontal plane 1 located a distance $d = y_2 - y_1$ below another horizontal plane 2 is

$$P_1 = P_2 + \rho g d$$

(stationary liquid, 1 below 2)

(a) Imaginary cylindrical volume of liquid at rest inside larger volume of same liquid

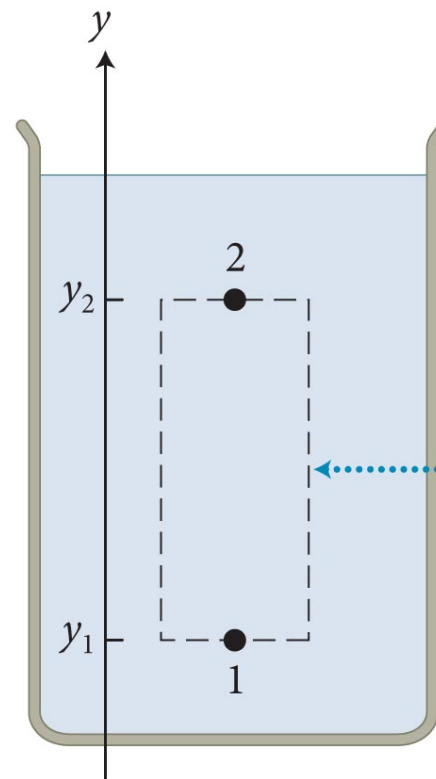

(b) Free-body diagram for cylinder

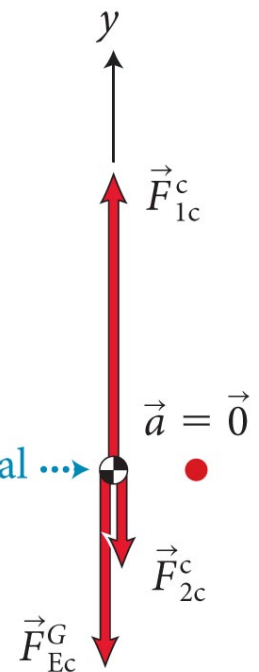

Section 18.5: Pressure and gravity

- If we let point 2 to be at the surface, then the pressure at depth $d = y_2 - y_1$ is

$$P = P_{\text{surface}} + \rho g d \quad (\text{stationary liquid})$$

- The term that contains g in this equation is the gravitational contribution to pressure and is referred to as *hydrostatic pressure*.

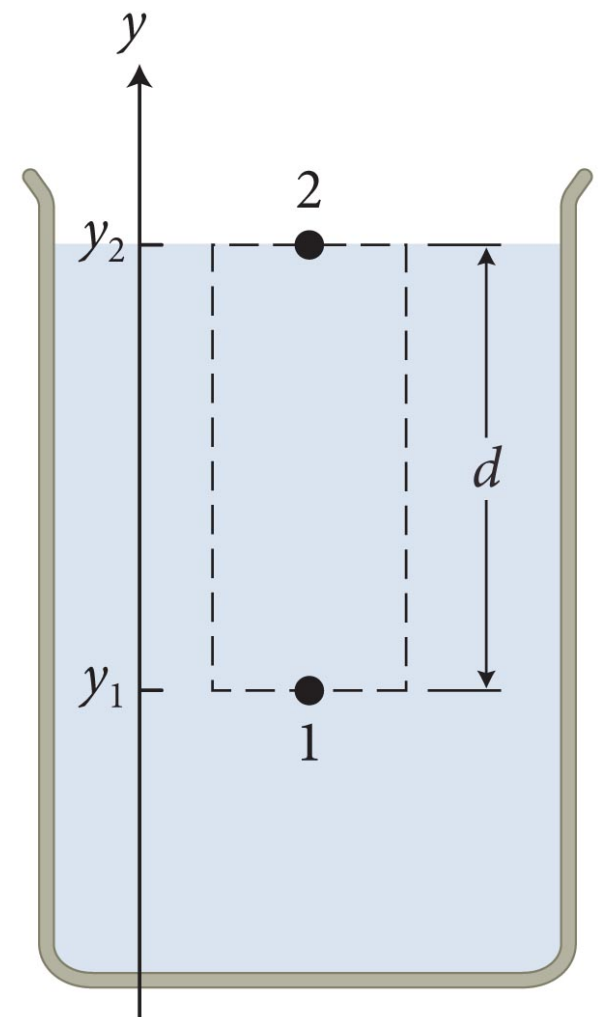

Section 18.5: Pressure and gravity

- Now consider two connected tubes filled with a liquid, one wide and one narrow, as shown. Both tubes are open to the atmosphere.
- The pressure at points 1 and 2 is given by

$$P_1 = P_{\text{atm}} + \rho g d_1 \text{ and } P_2 = P_{\text{atm}} + \rho g d_2$$

- Because these points are at the same horizontal level, we have $P_1 = P_2$, and hence $d_1 = d_2$.
- A stationary connected liquid rises to the same height in all open regions of the container.

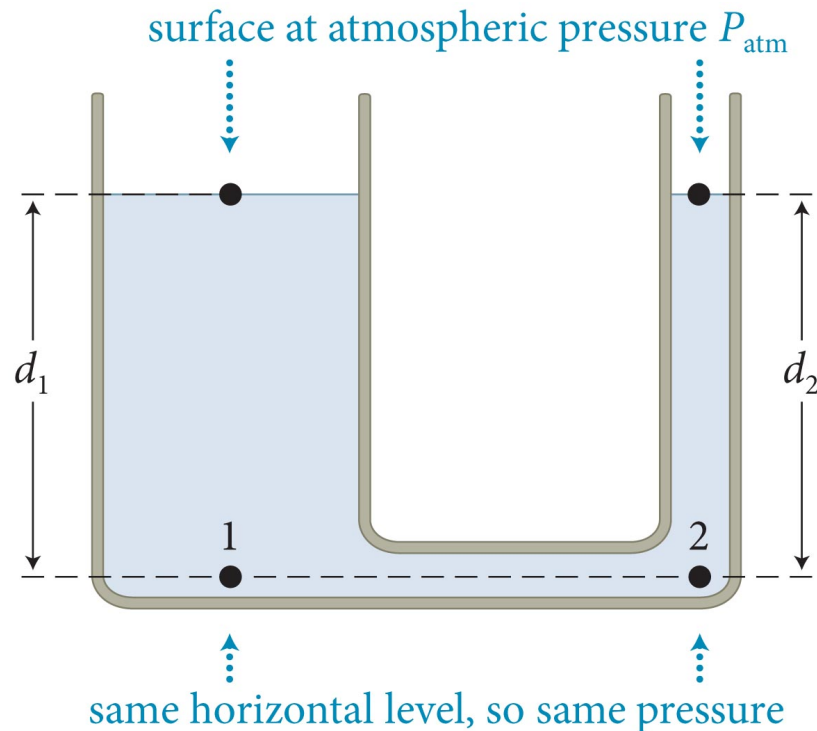

Section 18.5: Pressure and gravity

Example 18.6 Dam

A dam of horizontal length ℓ holds water of mass density ρ to a height h . What is the magnitude of the force exerted by the water on the dam?

Section 18.5: Pressure and gravity

Example 18.6 Dam (cont.)

① GETTING STARTED I begin with a sketch (Figure 18.43a).

The pressure in the water behind the dam is equal to atmospheric pressure at the water surface and increases linearly with depth as given by Eq. 18.8. If I choose my y axis pointing upward, with the origin at the bottom of the dam, the pressure varies with y as shown in Figure 18.43b. For convenience, I call the water side of the dam face A and the opposite side face B.

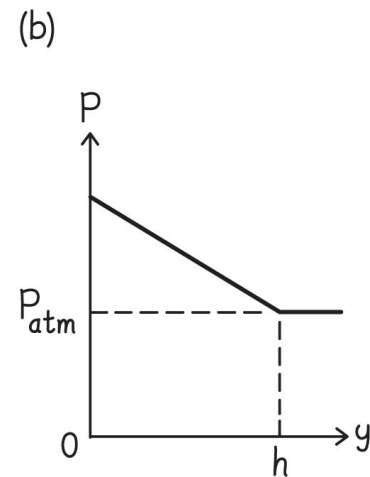
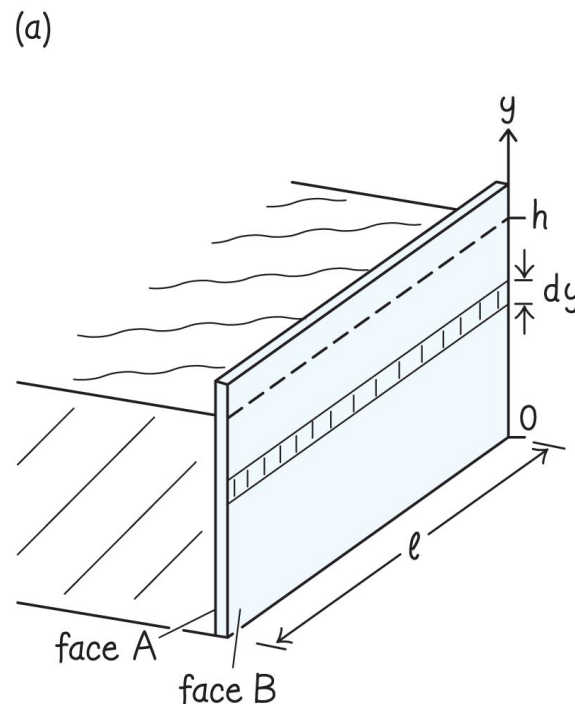

Section 18.5: Pressure and gravity

Example 18.6 Dam (cont.)

② DEVISE PLAN

Because the pressure varies with y , the magnitude of the force \vec{F}_{wd} also varies with y . I therefore divide the area of face A into thin horizontal strips each of width dy (Figure 18.43a).

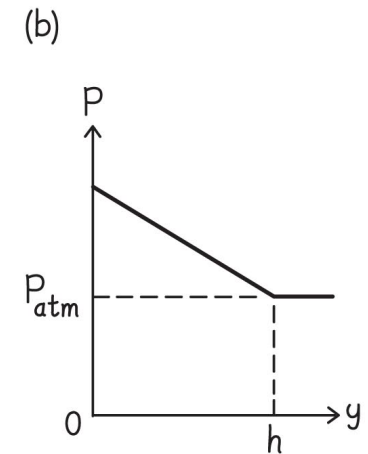
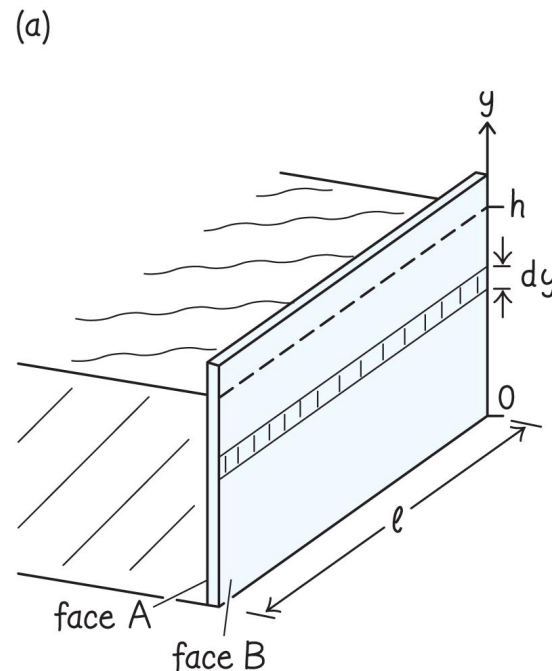

Section 18.5: Pressure and gravity

Example 18.6 Dam (cont.)

② DEVISE PLAN Because I know the pressure at a given value of y , I can calculate the force dF_{wd} exerted on the strip. To calculate the force exerted by the water on the whole dam, I integrate my expression over y from $y = 0$ at the bottom of the dam to $y = h$ at the water surface.

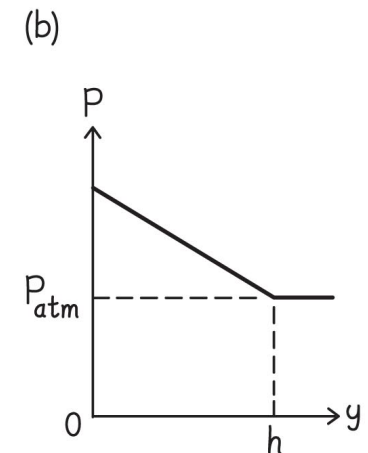
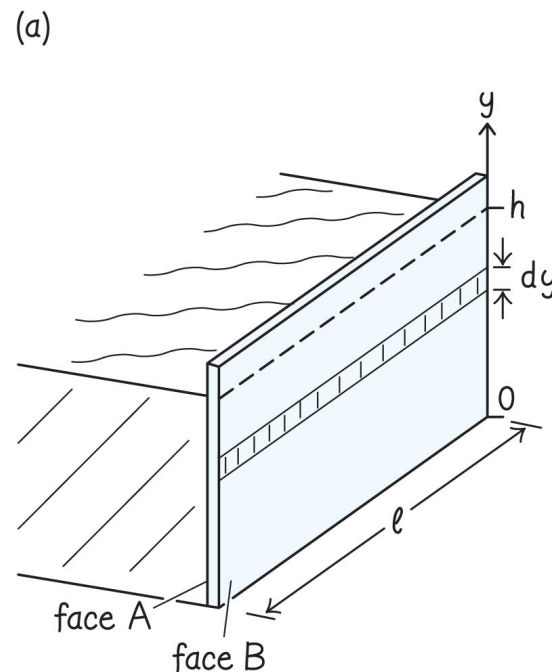

Section 18.5: Pressure and gravity

Example 18.6 Dam (cont.)

3 EXECUTE PLAN Because a point in the water located at some arbitrary value of y is at a depth $d = h - y$ below the water surface and because $P_{\text{surface}} = P_{\text{atm}}$, I write Eq. 18.8 in the form

$$P(y) = P_{\text{atm}} + \rho g(h - y).$$

Section 18.5: Pressure and gravity

Example 18.6 Dam (cont.)

3 EXECUTE PLAN The area of each strip is $dA = \ell dy$, and so the magnitude of the force exerted by the water on each strip is $dF = P(y)dA = P(y)\ell dy$. The magnitude of the force exerted by the water on the entire dam is then

$$\begin{aligned} F_{\text{wd}} &= \int dF_{\text{ws}} = \ell \int_0^h P(y) dy = \ell \left[P_{\text{atm}} y + \rho g h y - \frac{1}{2} \rho g y^2 \right]_0^h \\ &= \ell h \left(P_{\text{atm}} + \frac{1}{2} \rho g h \right). \quad \checkmark \end{aligned}$$

Section 18.5: Pressure and gravity

Example 18.6 Dam (cont.)

④ EVALUATE RESULT The product ℓh is the surface area of the dam, and so the term $\ell h P_{\text{atm}}$ is the magnitude of the force exerted by the atmosphere on the dam. Because the atmosphere exerts a force of the same magnitude on face B in the opposite direction, the first term in my answer drops out of the vector sum of the forces exerted by the water on face A of the dam and by the atmosphere on face B of the dam.

Section 18.5: Pressure and gravity

Example 18.6 Dam (cont.)

④ EVALUATE RESULT The remaining term, $\ell h(\frac{1}{2} \rho gh)$, is the product of the area of the face of the dam and $\frac{1}{2} \rho gh$, which is the pressure increase halfway down in the water. Because the pressure increases linearly with depth, this term represents the average value of the pressure increase between surface and bottom, and so my answer makes sense.

Section 18.5: Pressure and gravity

- The imaginary cylinder of liquid in the figure is held in place by the buoyant force $\vec{F}_{1v}^b = \vec{F}_{1c}^c - \vec{F}_{2c}^c$ exerted by the surrounding liquid.
- The vector sum of the forces exerted on the cylinder is

$$\sum \vec{F}_v = \vec{F}_{1v}^b + \vec{F}_{Ev}^G = \vec{0}$$

- Because $F_{Ev}^G = \rho Vg$, the magnitude of the **buoyant force** is

$$F_{1v}^b = \rho Vg$$

(a) Imaginary cylindrical volume of liquid at rest inside larger volume of same liquid

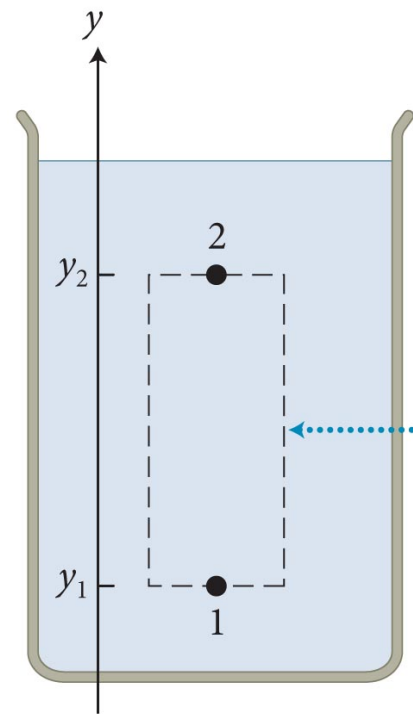

(b) Free-body diagram for cylinder

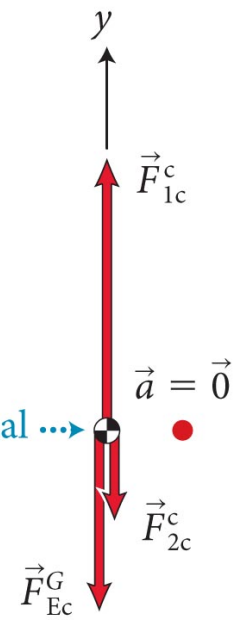

Section 18.5: Pressure and gravity

- However, this expression for buoyant force holds for any object in any fluid.
- So, the buoyant force on any object o in a fluid f is

$$F_{fo}^b = \rho_f V_{\text{disp}} g$$

where V_{disp} is the displaced volume of fluid and ρ_f is the density of the fluid.

- *Net* force is buoyant – weight: $\rho_f V_{\text{disp}} g - \rho_o V_{\text{disp}} g = (\rho_f - \rho_o) V_{\text{disp}} g$
- For an object that is floating, the displaced volume is less than the volume of the object, and therefore we get

$$\rho_{o,\text{av}} < \rho_f \text{ (object floats)}$$

- If an object sinks, the buoyant force is smaller than the gravitational force, and we get

$$\rho_{o,\text{av}} > \rho_f \text{ (object sinks)}$$

Section 18.5

Question 8

Which of the following effects contributes to the pressure in a liquid but not in a gas?

1. Gravitational force
2. Motion of the fluid
3. Collisions
4. Surface tension

Section 18.5

Question 8

Which of the following effects contributes to the pressure in a liquid but not in a gas?

1. Gravitational force
2. Motion of the fluid
3. Collisions
- ✓ 4. Surface tension

PRINCIPLES & PRACTICE OF
PHYSICS

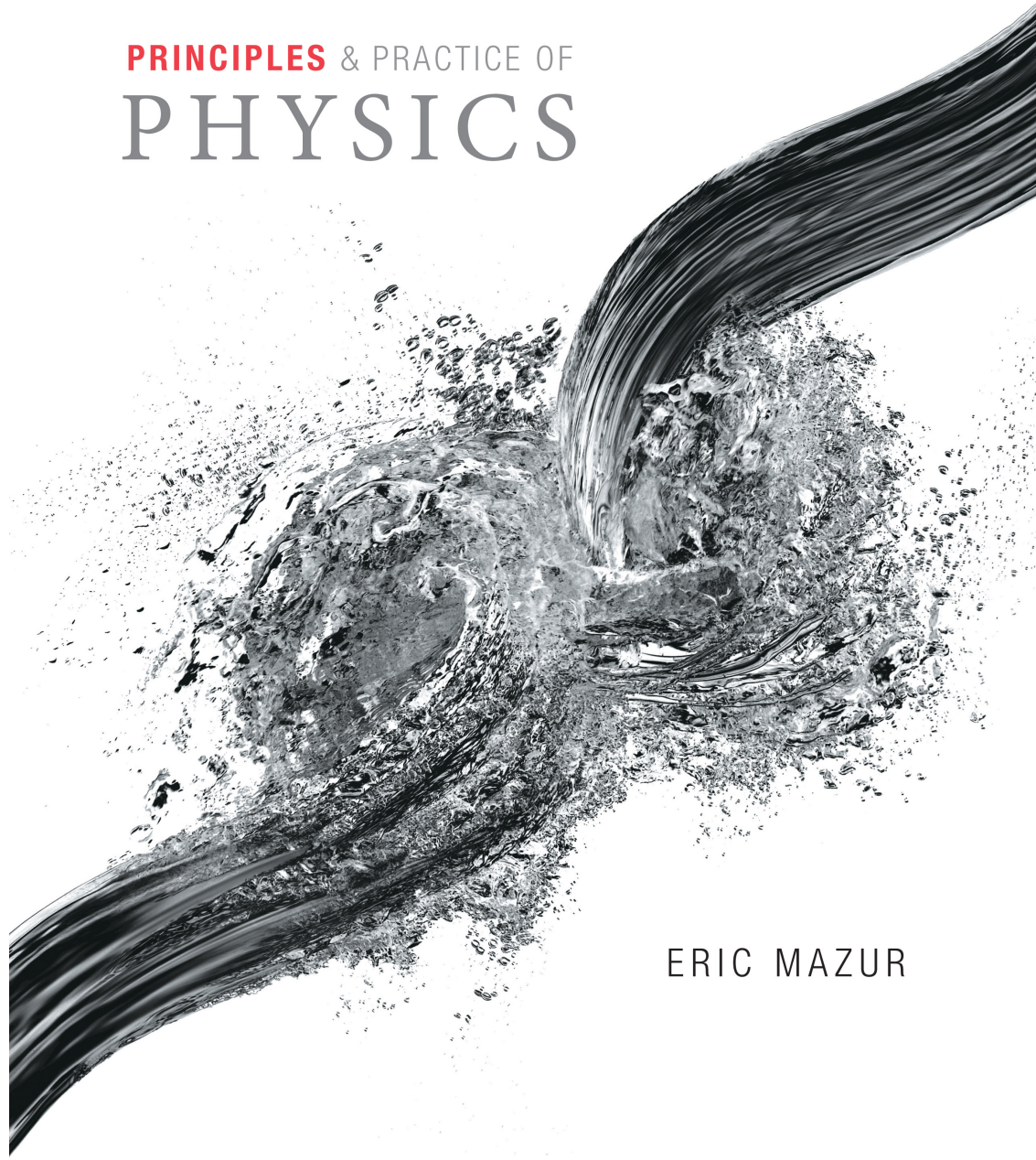

ERIC MAZUR

Checkpoint 18.15



18.15 An object floats with 80% of its volume submerged in water. How does the average mass density of the object compare with that of water?

Buoyant force: weight of water displaced

$$B = 0.8 \times (\text{object volume}) \times (\text{liquid density}) \times g$$

Weight of object:

$$mg = (\text{object volume}) \times (\text{object density}) \times g$$

In equilibrium, $B - mg = 0$, so

$$(\text{object density}) = 0.8 \times (\text{liquid density})$$

Section 18.6: Working with pressure

Section Goals

You will learn to

- Recognize several pressure-measuring devices and model mathematically how they are calibrated.
- Understand the basics of hydraulic systems and how to apply Pascal's principle to them.

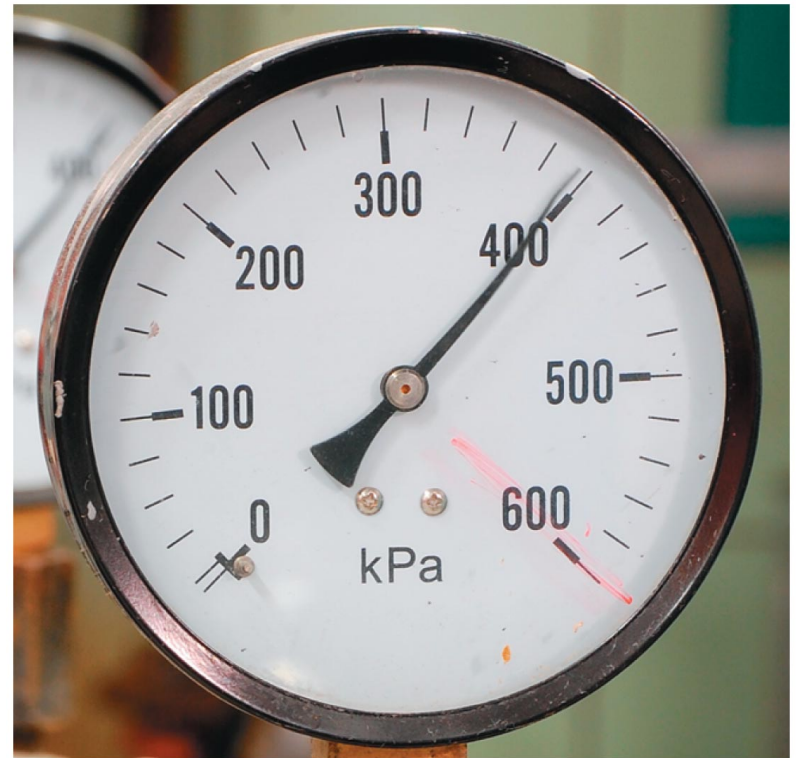

Section 18.6: Working with pressure

- Many *pressure gauges*, such as tire gauges, measure not the actual pressure P but what is called **gauge pressure** P_{gauge} , where

$$P = P_{\text{gauge}} + P_{\text{atm}}$$

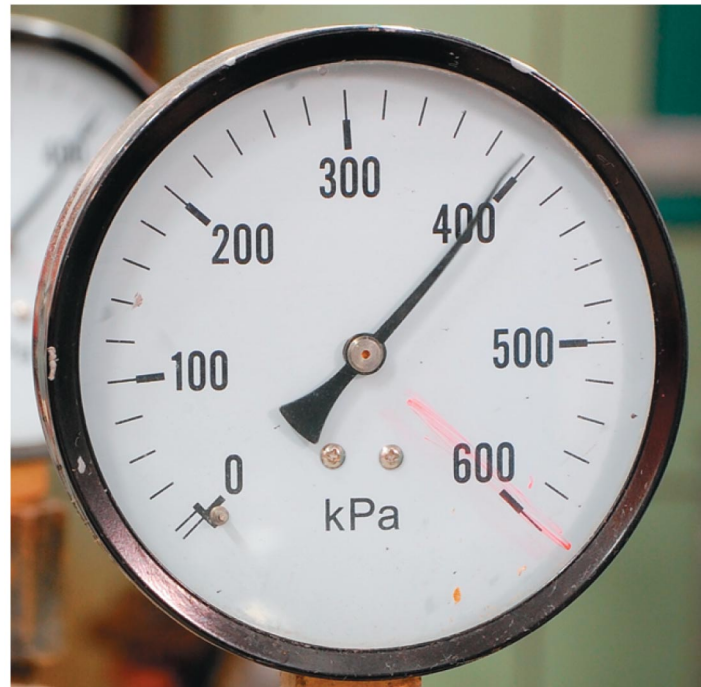

Section 18.6: Working with pressure

- The simplest pressure gauge is the open-tube *manometer*.
- The tube is filled with liquid mercury of density ρ .
- We can use Equation 18.7 to find the pressure P :

$$P = P_{\text{atm}} + \rho gh$$

- Same result by balancing forces on either side at y_{left} — difference in pressure is the weight of the excess mercury

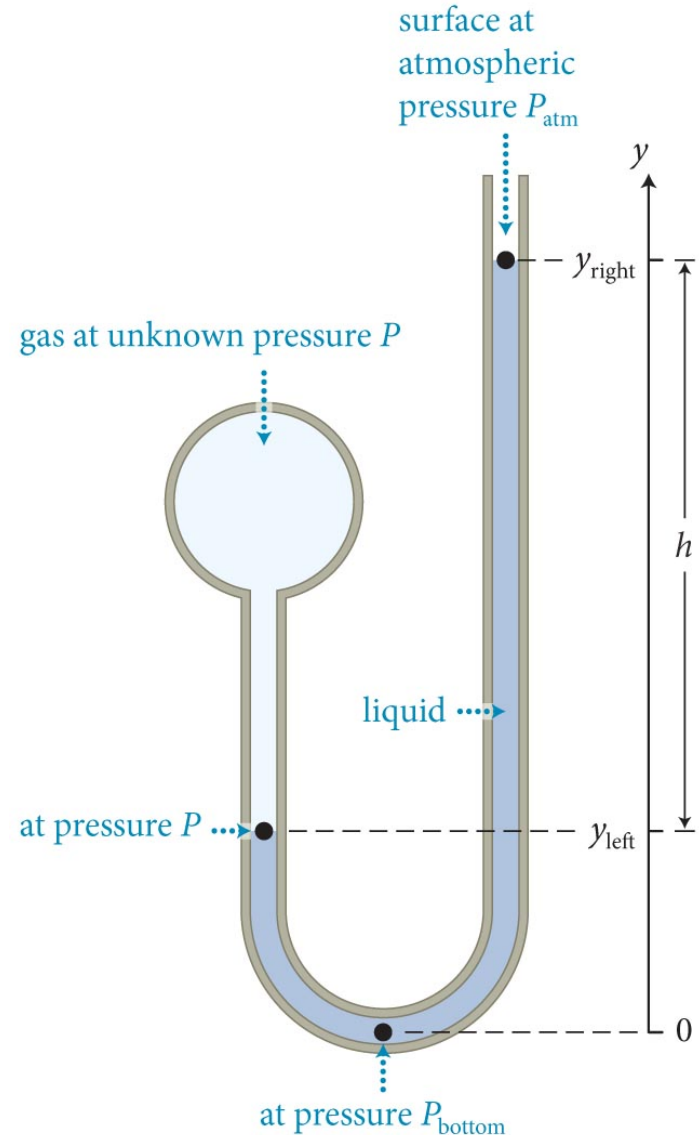

Section 18.6: Working with pressure

- We can use a *barometer* to measure the atmospheric pressure.
- We fill the tube completely with a liquid, cover the top end, invert the tube, place it in an open container of the same liquid, and remove the cover.
- We then measure the height h of the liquid column in the tube.
- Equation 18.7 gives

$$P_{\text{atm}} = \rho gh$$

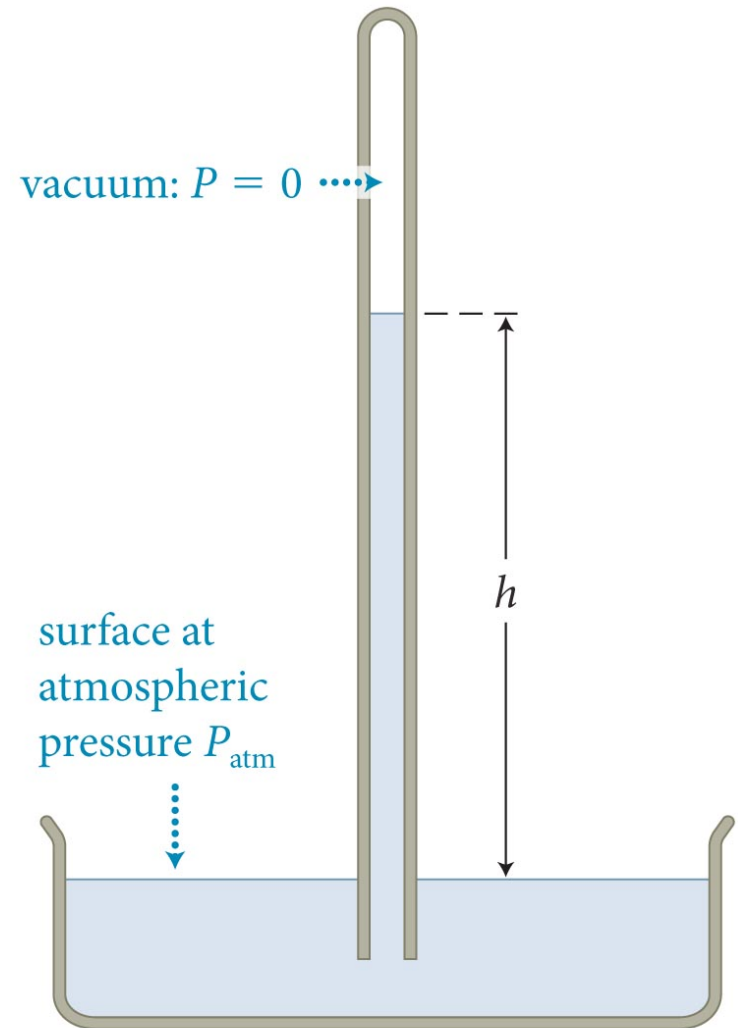

Section 18.6: Working with pressure

- With $P_{\text{atm}} = \rho gh = 101.325 \text{ kPa}$, using Pb with $\rho = 13,594 \text{ kg/m}^3$...
$$h = 760 \text{ mm (29.92 in)} = 1 \text{ Torr}$$
- That's where that nonsense about “inches of mercury” comes from on the weather report.
- Curious: using water density (1000 kg/m^3), we get $h = 10.3 \text{ m}$, 1 atm can only draw up that much water
- That means the largest possible straw is 10.3 m tall, no matter what

Section 18.6: Working with pressure

Example 18.7 Liquid support

In Figure 18.47, the top tank, which is open to the atmosphere, contains water ($\rho_{\text{water}} = 1.0 \times 10^3 \text{ kg/m}^3$) and the bottom tank contains oil ($\rho_{\text{oil}} = 0.92 \times 10^3 \text{ kg/m}^3$) covered by a piston. The tank on the right has a freely movable partition that keeps the oil and water separate.

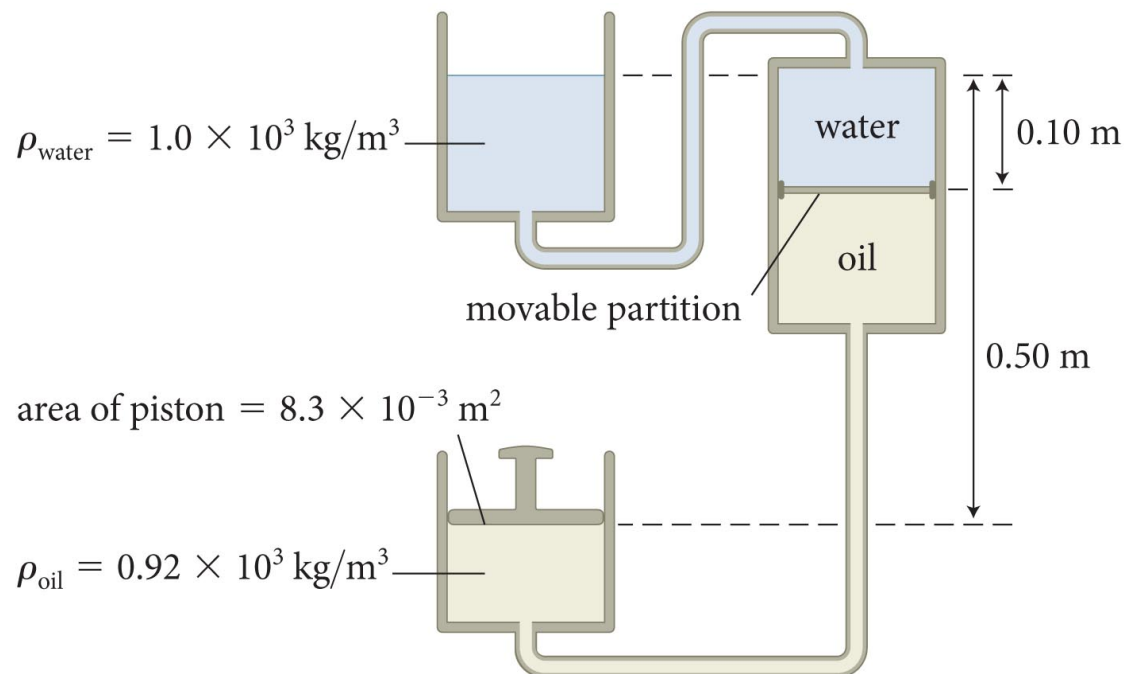

Section 18.6: Working with pressure

Example 18.7 Liquid support (cont.)

The partition is a vertical distance 0.10 m below the open surface of the water. If the piston in the bottom tank is 0.50 m below the open surface of the water and has a surface area of $8.3 \times 10^{-3} \text{ m}^2$, what must the mass of the piston be to keep the system in mechanical equilibrium? For simplicity, ignore the mass of the partition.

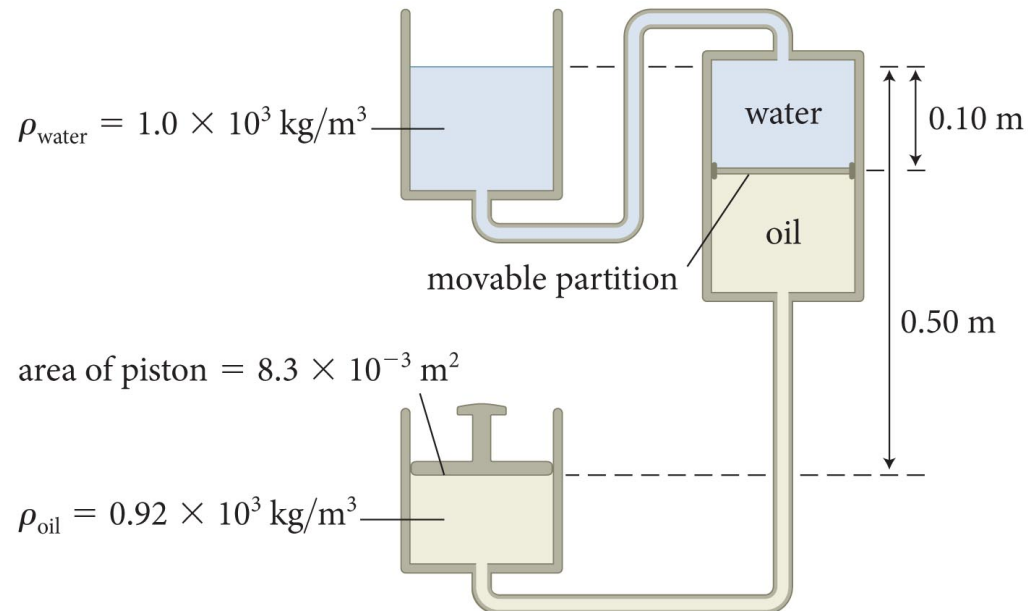

Section 18.6: Working with pressure

Example 18.7 Liquid support (cont.)

1 GETTING STARTED

I begin by making a sketch of the arrangement and identifying points of interest (Figure 18.48a). Point 1 is at the water surface in the top tank, and the pressure here is atmospheric pressure. Point 2 is on the partition in the right tank separating the water from the oil.

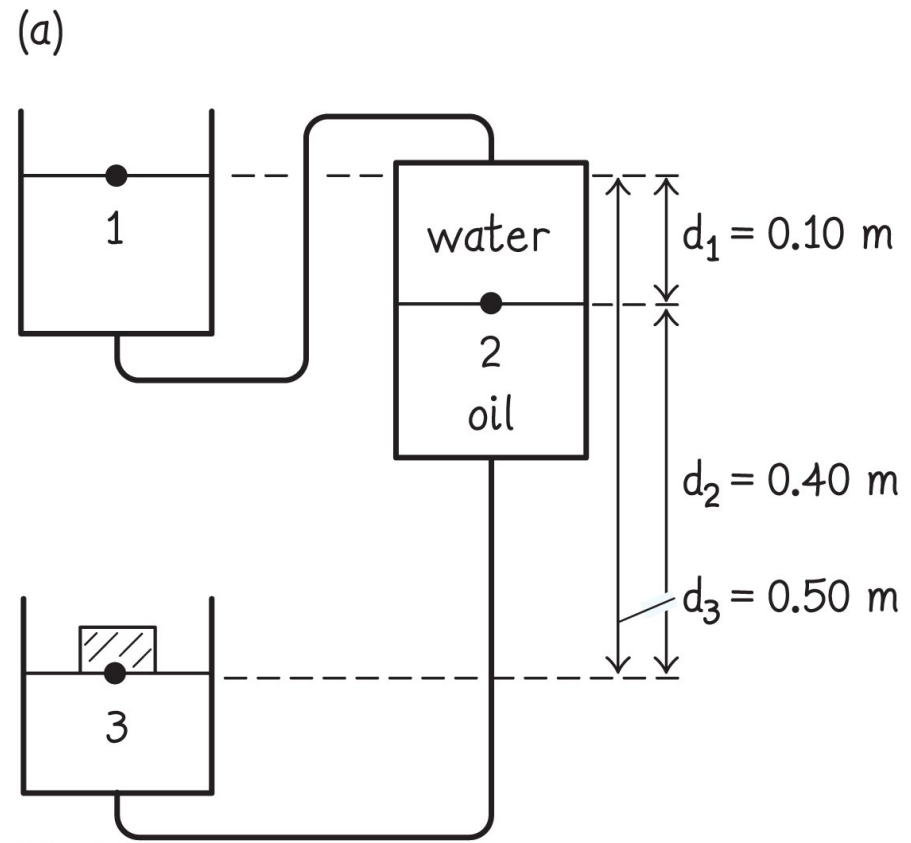

Section 18.6: Working with pressure

Example 18.7 Liquid support (cont.)

1 GETTING STARTED

In mechanical equilibrium, the partition is not accelerating, and so, because I ignore the partition mass, the pressure must be the same on the two sides of the partition. Point 3 is at the position in the bottom tank where the oil and piston meet.

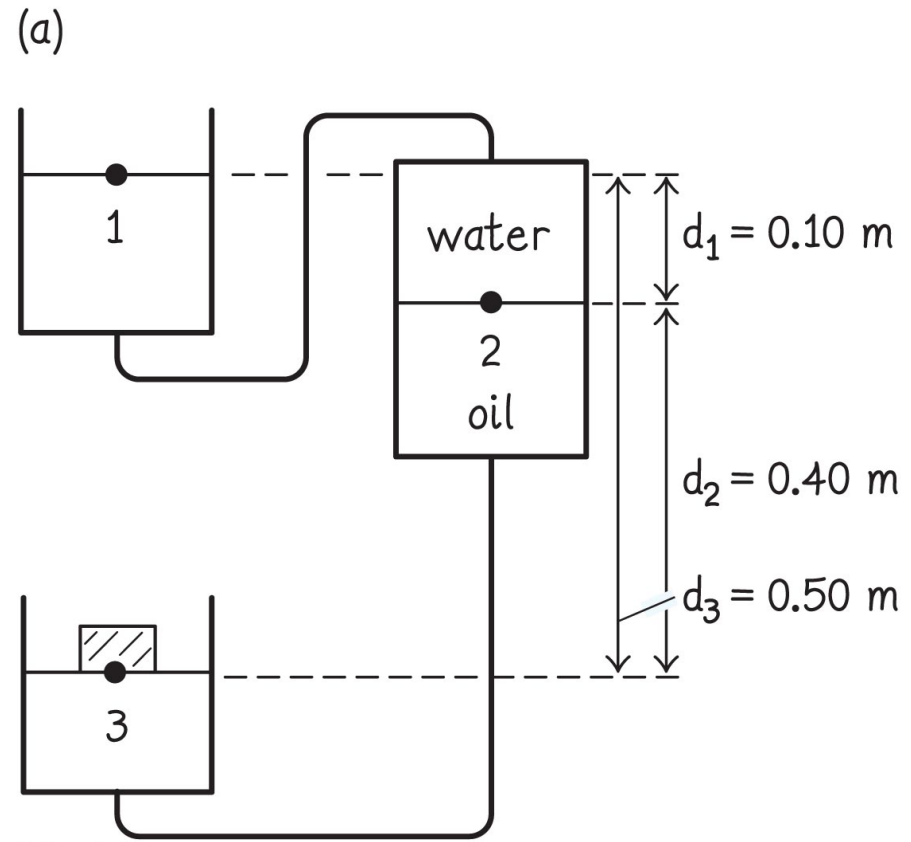

Section 18.6: Working with pressure

Example 18.7 Liquid support (cont.)

1 GETTING STARTED I also draw a free-body diagram for the piston, which also has zero acceleration in mechanical equilibrium (Figure 18.48*b*). The piston is subject to an upward force \vec{F}_{op}^c exerted by the oil, a downward force \vec{F}_{ap}^c exerted by the air above the piston, and a downward gravitational force \vec{F}_{Ep}^G .

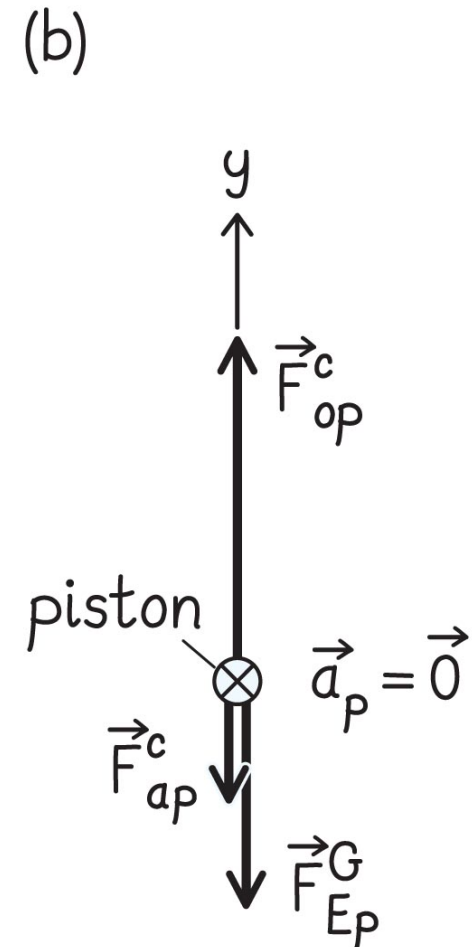

Section 18.6: Working with pressure

Example 18.7 Liquid support (cont.)

② **DEVISE PLAN** When the system is in mechanical equilibrium, the piston is stationary. Therefore the vector sum of the forces exerted on it must be zero. From my free-body diagram, I see that the magnitude of the upward force exerted by the oil on the piston is equal in magnitude to the sum of the downward gravitational force exerted on the piston and the downward force exerted by the air on the piston:

$$F_{\text{op}}^{\text{c}} = F_{\text{Ep}}^{\text{G}} + F_{\text{ap}}^{\text{c}} = m_{\text{p}}g + F_{\text{ap}}^{\text{c}}.$$

Section 18.6: Working with pressure

Example 18.7 Liquid support (cont.)

② **DEVISE PLAN** The magnitudes F_{ap}^c and F_{op}^c are given by a rearranged form of Eq. 18.1: $F_{\text{ap}}^c = P_{\text{air}} A_{\text{piston}}$, and $F_{\text{op}}^c = P_3 A_{\text{piston}}$.

The problem reduces to determining P_3 at point 3, where the oil and piston meet. That point is 0.40 m below the partition, where the pressure is P_2 . Because points 2 and 3 are in a connected liquid (the oil), I can relate P_2 and P_3 . Points 1 and 2 are also in a connected liquid (the water), so I can relate P_2 and $P_1 = P_{\text{atm}}$.

Section 18.6: Working with pressure

Example 18.7 Liquid support (cont.)

3 EXECUTE PLAN Because the vector sum of the forces exerted on the piston is zero, I have

$$F_{\text{op}}^c - F_{\text{ap}}^c - F_{\text{Ep}}^G = P_3 A_{\text{piston}} - P_{\text{air}} A_{\text{piston}} - m_{\text{piston}} g = 0,$$

or

$$m_{\text{piston}} = \frac{(P_3 - P_{\text{air}}) A_{\text{piston}}}{g}. \quad (1)$$

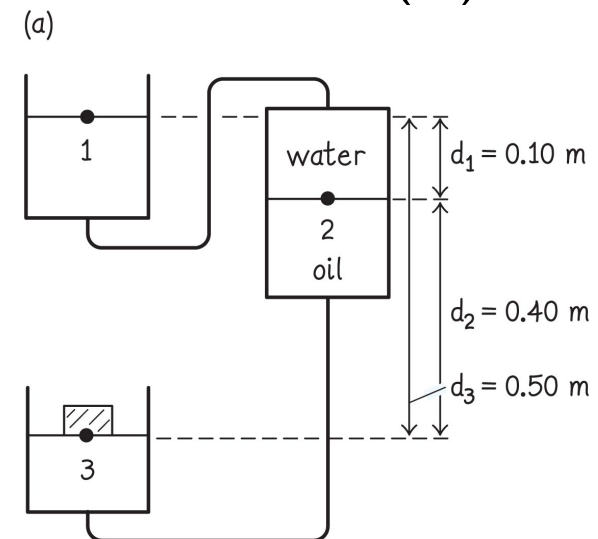

Section 18.6: Working with pressure

Example 18.7 Liquid support (cont.)

③ EXECUTE PLAN To get P_3 , I first apply Eq. 18.7 to points 1 and 2, remembering that the lower point always goes on the left side of the equation: $P_2 = P_1 + \rho_{\text{water}}gd_1 = P_{\text{air}} + \rho_{\text{water}}gd_1$. Then I it to points 2 and 3: $P_3 = P_2 + \rho_{\text{oil}}gd_2 = P_{\text{air}} + \rho_{\text{water}}gd_1 + \rho_{\text{oil}}gd_2$. Substituting:

$$m_{\text{piston}} = \frac{(P_{\text{air}} + \rho_{\text{water}}gd_1 + \rho_{\text{oil}}gd_2 - P_{\text{air}})A_{\text{piston}}}{g}$$

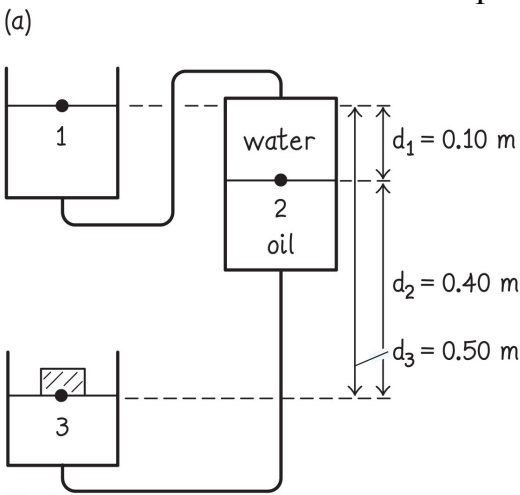

$$= (\rho_{\text{water}} d_1 + \rho_{\text{oil}} d_2)A_{\text{piston}}$$

$$= [(1.0 \times 10^3 \text{ kg/m}^3)(0.10 \text{ m}) + (0.92 \times 10^3 \text{ kg/m}^3)(0.40 \text{ m})] (8.3 \times 10^{-3} \text{ m}^2) = 3.9 \text{ kg. } \checkmark$$

Section 18.6: Working with pressure

Example 18.7 Liquid support (cont.)

④ EVALUATE RESULT The atmospheric pressure term drops out because it affects both the water surface and the piston. Points 1 and 3 are separated by 0.5 m.

Because I know that the pressure difference due to 10 m of water is equal to atmospheric pressure at sea level, or about 100 kPa (this is handy to remember), I know that 0.5 m of water should correspond to a pressure difference of about 5 kPa.

Section 18.6: Working with pressure

Example 18.7 Liquid support (cont.)

4 EVALUATE RESULT The mass density of oil is a bit smaller than that of water, but I can ignore the difference. The surface area of the piston is about 10^{-2} m^2 , and so the force giving rise to the 5-kPa pressure difference is about 50 N, which is equal to the gravitational force exerted on a mass of 5 kg, which is close to the answer I obtained.

Section 18.6: Working with pressure

Example 18.8 Liquid work

Suppose a load is placed on the large piston in Figure 18.50 and we wish to raise that load by a certain distance. How does the work done on the small piston compare with the work required to raise the load? Ignore the masses of the pistons.

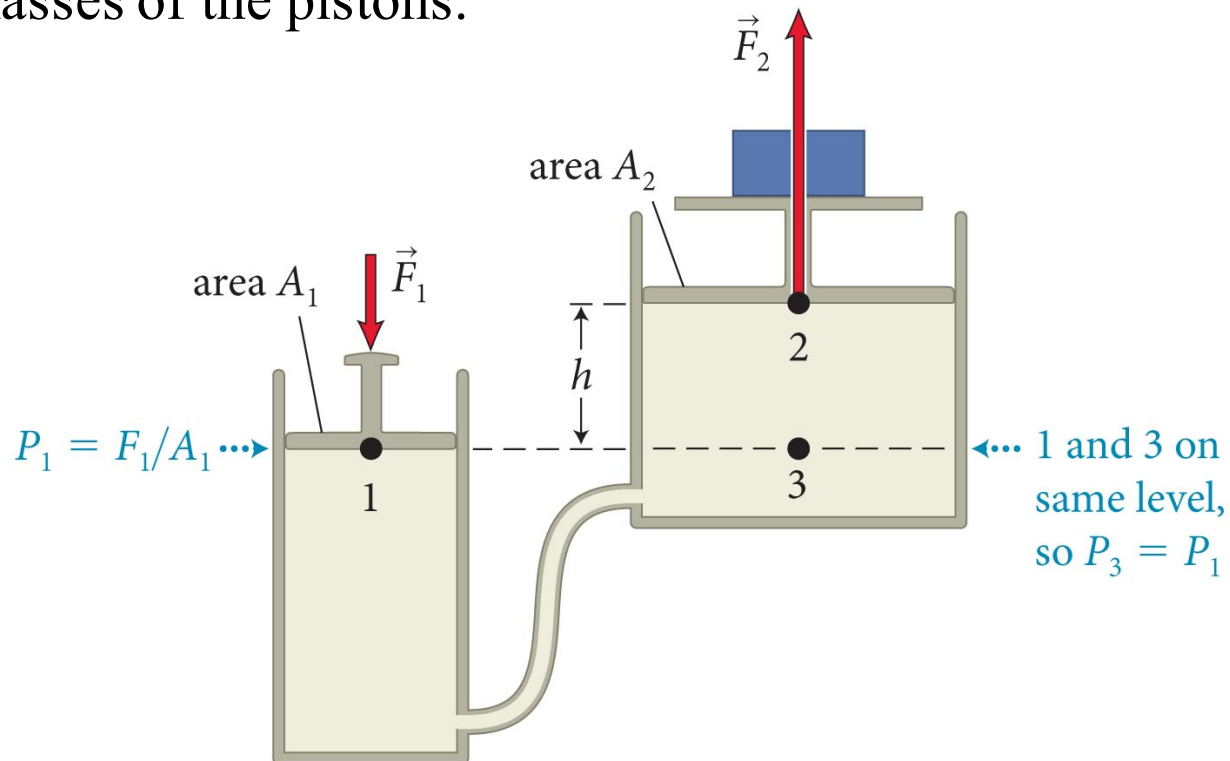

Section 18.6: Working with pressure

Example 18.8 Liquid work (cont.)

① GETTING STARTED I begin by making a sketch (Figure 18.51). To keep my subscripts simple, I call the small piston 1 and the large piston 2. I denote the displacements of the two pistons by $\Delta\vec{x}_1$ and $\Delta\vec{x}_2$, and the forces exerted on them by \vec{F}_1 and \vec{F}_2 .

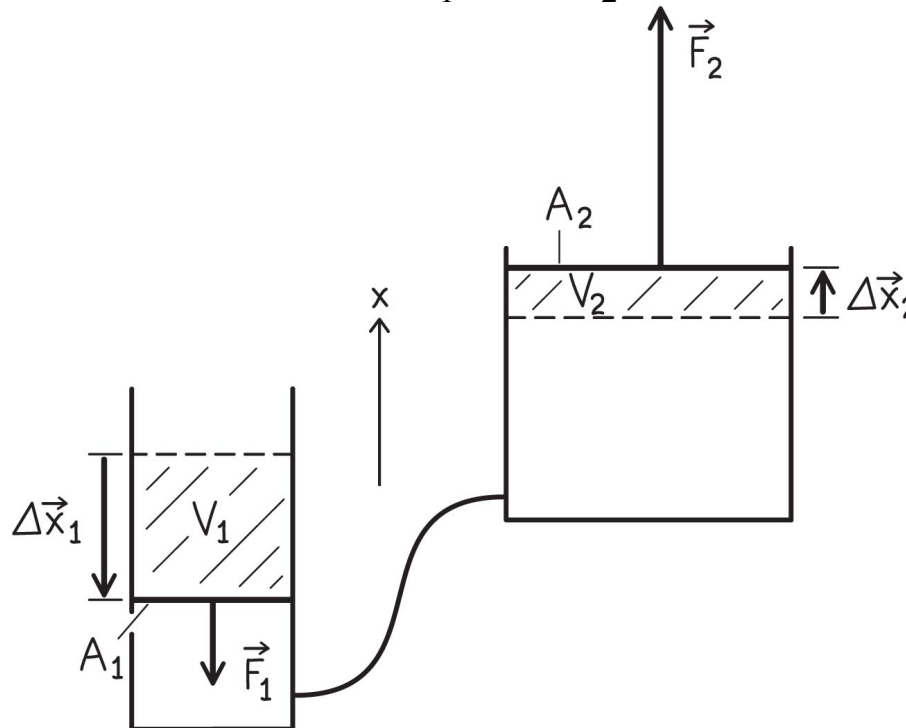

Section 18.6: Working with pressure

Example 18.8 Liquid work (cont.)

② DEVISE PLAN We know $P_1 = P_2$ and thus $F_1/A_1 = F_2/A_2$, which gives $F_1 = (A_1/A_2)F_2$.

Each force does an amount of work given by the scalar product of the force and the force displacement, which is equal to the displacement of the piston on which the force is exerted.

Both forces do positive work because the direction of each force is the same as the direction of the force displacement.

Section 18.6: Working with pressure

Example 18.8 Liquid work (cont.)

② DEVISE PLAN Because the liquid in the cylinders is incompressible, I know that the volume V_1 of liquid pushed out of the small cylinder must be equal to the volume V_2 of liquid pushed into the large cylinder: $V_1 = V_2$.

This expression will help me relate the piston displacements to the piston surface areas.

Generally speaking, ‘conservation of stuff’ is a go-to thing.

Section 18.6: Working with pressure

Example 18.8 Liquid work (cont.)

③ EXECUTE PLAN Raising the load a distance $d = \Delta x_2$ requires work $W_2 = \vec{F}_2 \cdot \Delta\vec{x}_2 = F_2 d$. With $F_1 = (A_1/A_2)F_2$, the work done on the small piston is

$$W_1 = \vec{F}_1 \cdot \Delta\vec{x}_1 = F_1 \Delta x_1 = F_2 \frac{A_1}{A_2} \Delta x_1. \quad (1)$$

Section 18.6: Working with pressure

Example 18.8 Liquid work (cont.)

③ EXECUTE PLAN The volume of liquid pushed out of the small cylinder is $V_1 = A_1\Delta x_1$, and that pushed into the large cylinder is $V_2 = A_2\Delta x_2 = A_2d$. Because these two volumes are equal, I have $A_1\Delta x_1 = A_2d$, or $\Delta x_1 = (A_2/A_1)d$. Substituting this expression into Eq. 1, I get $W_1 = F_2d$, telling me that the same work is done on both pistons. ✓

Which had to be the case, right?

Would our answer change if there was viscosity?

Section 18.6: Working with pressure

Example 18.8 Liquid work (cont.)

④ EVALUATE RESULT My answer tells me that no energy is gained by using the hydraulic lift, which makes sense. Gaining energy would be extraordinarily dangerous.

The force exerted on the small piston is increased by the factor A_2/A_1 when it is transmitted to the large piston, but the displacement decreases by the inverse factor A_1/A_2 , and so the work done is the same.

Section 18.6: Working with pressure

- This basically explains *hydraulic systems*.
- In hydraulic systems a liquid, usually oil, is used to transmit a force applied at one point to another point.
- You have probably used hydraulics today

(a) Basic hydraulic system

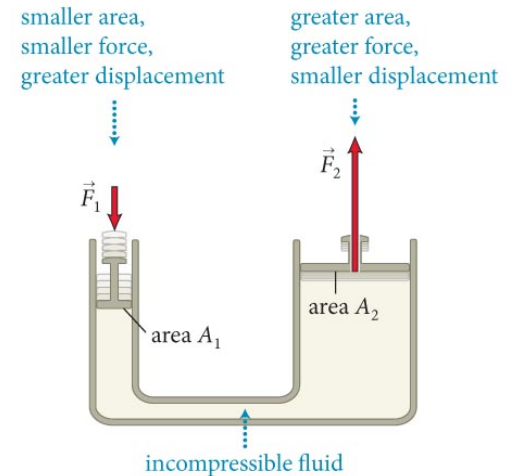

(b) Schematic model of hydraulic brake system

Mechanical lever multiplies force on brake pedal.

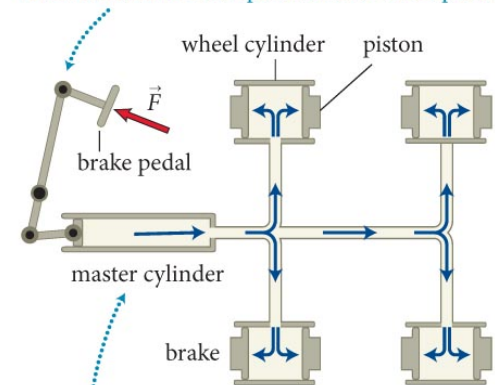

Hydraulic system multiplies and distributes force.

Section 18.6: Working with pressure

- A great advantage of hydraulic systems is that they permit us to “multiply” a force by varying the size of the pistons.
- Since pressure is constant, take advantage and vary the area!
- To see how this works, let us analyze a hydraulic lift, as shown.
- Since $P_1 = P_3$, we can write

$$P_2 = P_3 - \rho gh = P_1 - \rho gh$$

- Because ρ_{oil} and h are small, the term ρgh can be ignored.
- Using $P = F/A$, we can write

$$F_2 = \frac{A_2}{A_1} F_1$$

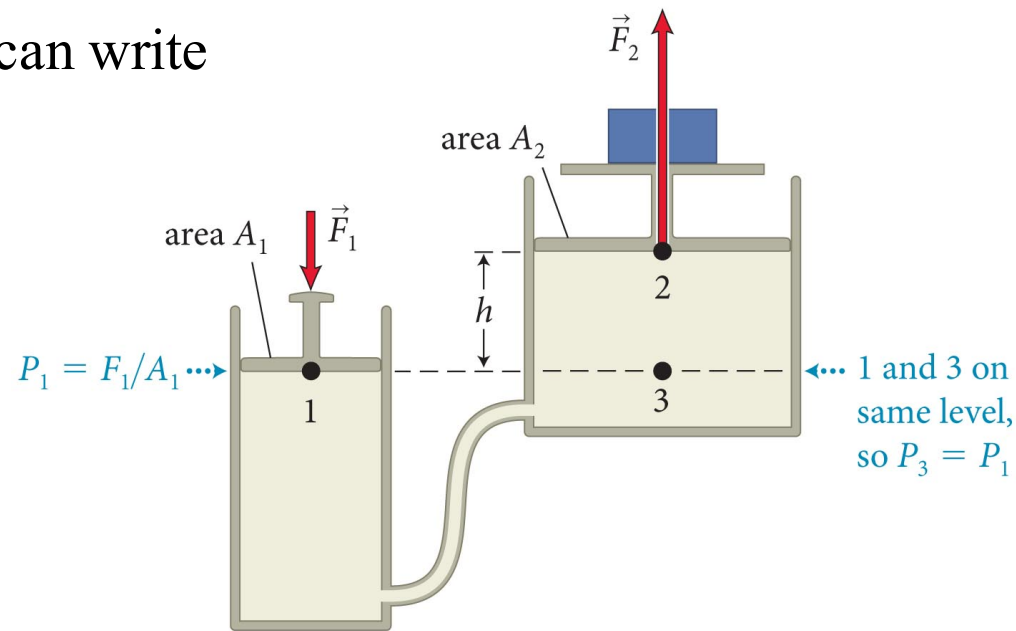

Section 18.6: Working with pressure

Procedure: Working with pressure in liquids at rest

The branch of physics that deals with pressure in a liquid at rest is called *hydrostatics*. The pressure in a liquid at rest is determined by gravity and by what happens at the boundary of the liquid. To determine the pressure in such liquids:

1. Begin by making a sketch showing all the **boundaries** and identifying all the factors that affect pressure: pistons, gases at surfaces open to the atmosphere, and so on. Note the known vertical heights of liquid surfaces, the areas of these surfaces, the surface areas of pistons, and the liquid mass densities.

Section 18.6: Working with pressure

Procedure: Working with pressure in liquids at rest

2. Determine the **pressure at each surface**. The pressure at a liquid surface open to the air is equal to atmospheric pressure P_{atm} . The pressure at a liquid surface bordering a vacuum is zero: $P = 0$. The pressure at a liquid surface open to a gas other than the atmosphere is equal to the pressure in the gas: $P = P_{\text{gas}}$. The pressure at a liquid surface that is in contact with a solid, such as a piston, is $P = F_{\text{sl}}^c/A$, where F_{sl}^c is the magnitude of the force exerted by the solid on the liquid and A is the area over which that force is exerted.

Section 18.6: Working with pressure

Procedure: Working with pressure in liquids at rest

3. Use **horizontal planes**. The pressure is the same at all points on a horizontal plane in a connected liquid. The pressure difference between two horizontal planes 1 and 2 is given by $P_1 = P_2 + \rho g d$ (Eq. 18.7), where d is the vertical distance between the horizontal planes and 1 is below 2.

Section 18.7: Bernoulli's equation

Section Goal

You will learn to

- Derive the **equation of continuity** for the laminar flow of a nonviscous fluid.
- Derive and apply **Bernoulli's equation** for situations involving fluids in motion.

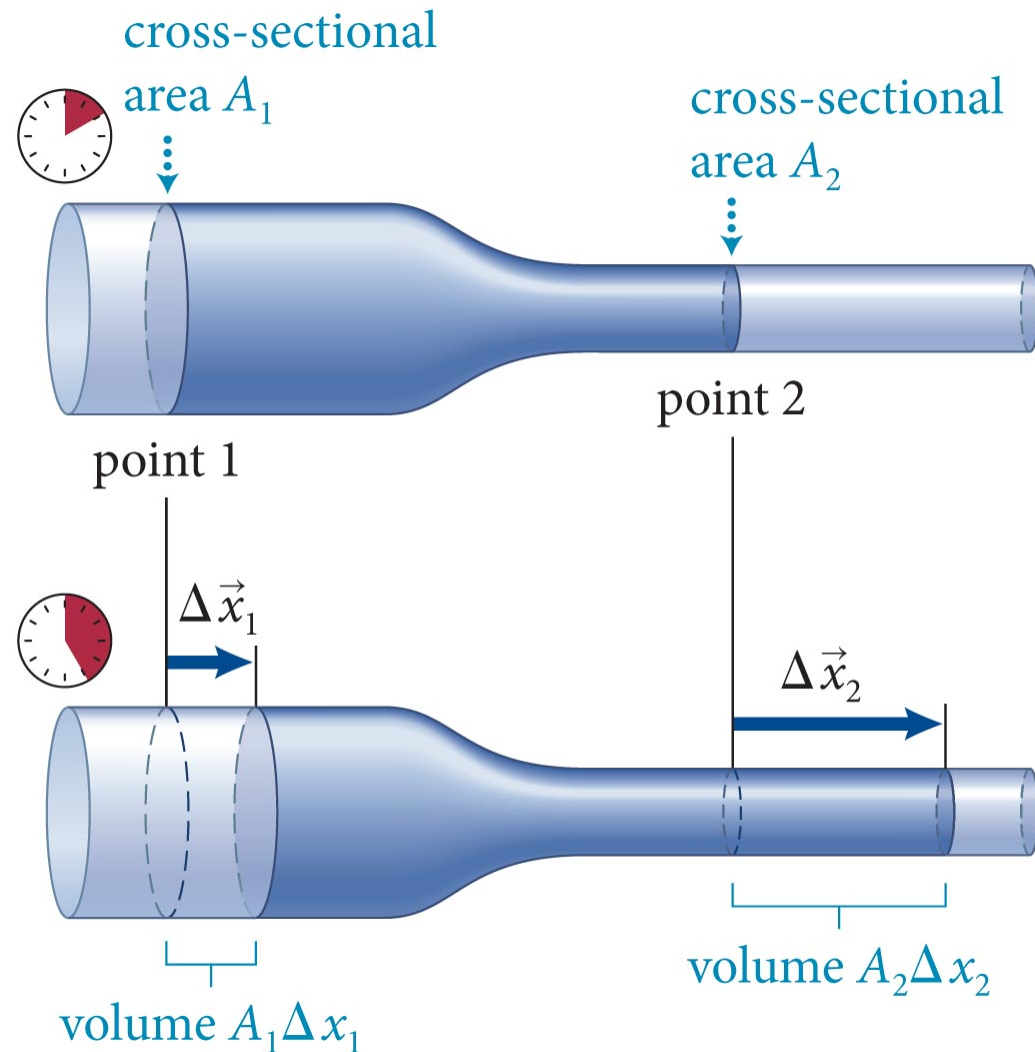

Section 18.7: Bernoulli's equation

- Laminar flow, nonviscous fluid through a tapered tube.
- The mass of the fluid emerging from the narrow part of the tube at point 2 during a time interval Δt is same as the mass entering at point 1.
- This observation gives us the **continuity equation**:

$$\rho_1 A_1 v_1 = \rho_2 A_2 v_2$$

(laminar flow, nonviscous fluid)

(Conservation of stuff FTW)

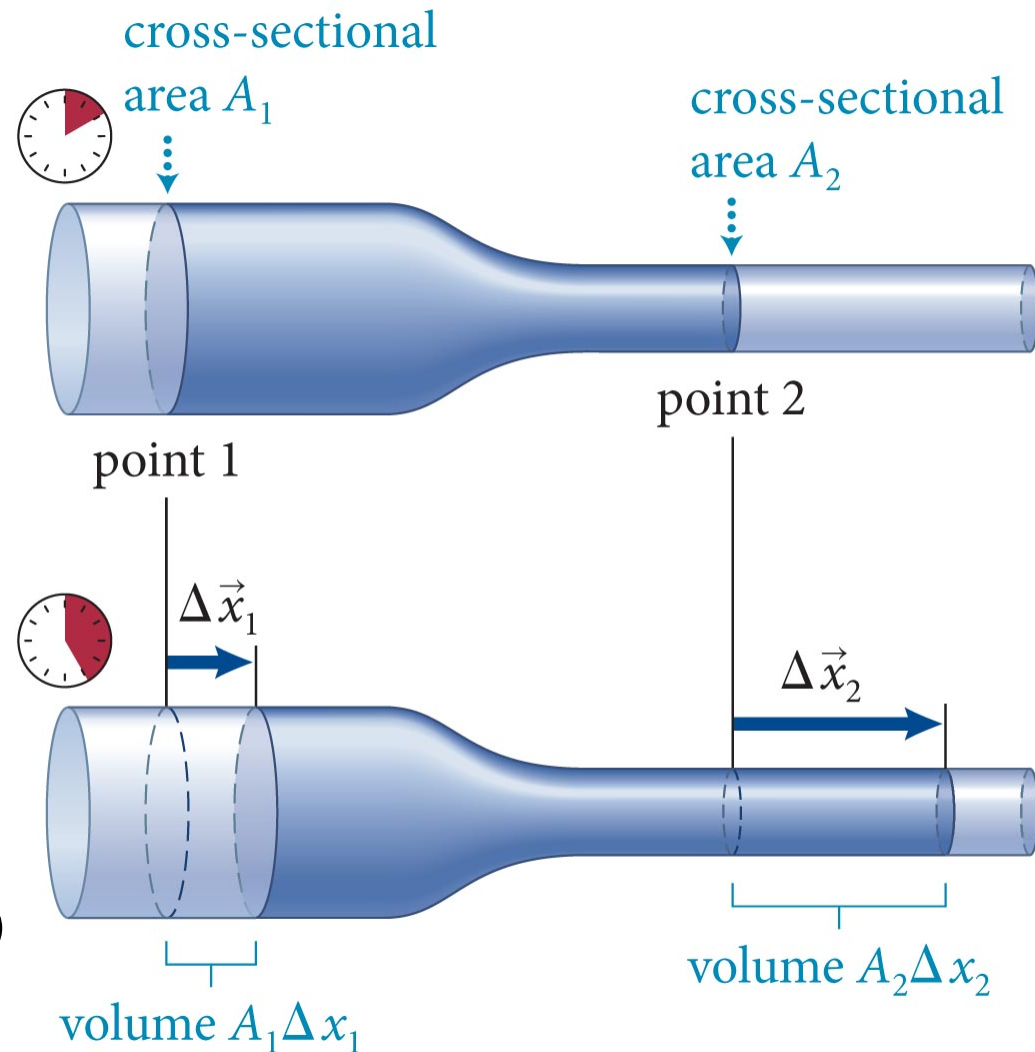

Section 18.7: Bernoulli's equation

- For an incompressible fluid, the continuity equation becomes $A_1v_1 = A_2v_2$ (laminar flow of nonviscous, incompressible fluid)
- The **volume flow rate** Q is the rate at which a volume of fluid crosses a section of a tube.
- The SI units of Q are m^3/s .
- For a nonviscous fluid,

$$Q = Av$$

- The continuity equation tells us that for a incompressible fluid $Q_1 = Q_2$.

Section 18.7: Bernoulli's equation

- Let us apply the energy law ($\Delta E = W$) to an incompressible fluid flowing in the tapered tube shown.
- Consider a mass m of fluid flowing across points 1 and 2 in time Δt .
- The change in energy is

$$\Delta E = \Delta K + \Delta U^G$$

$$= \frac{1}{2} m(v_2^2 - v_1^2) + mg(y_2 - y_1)$$

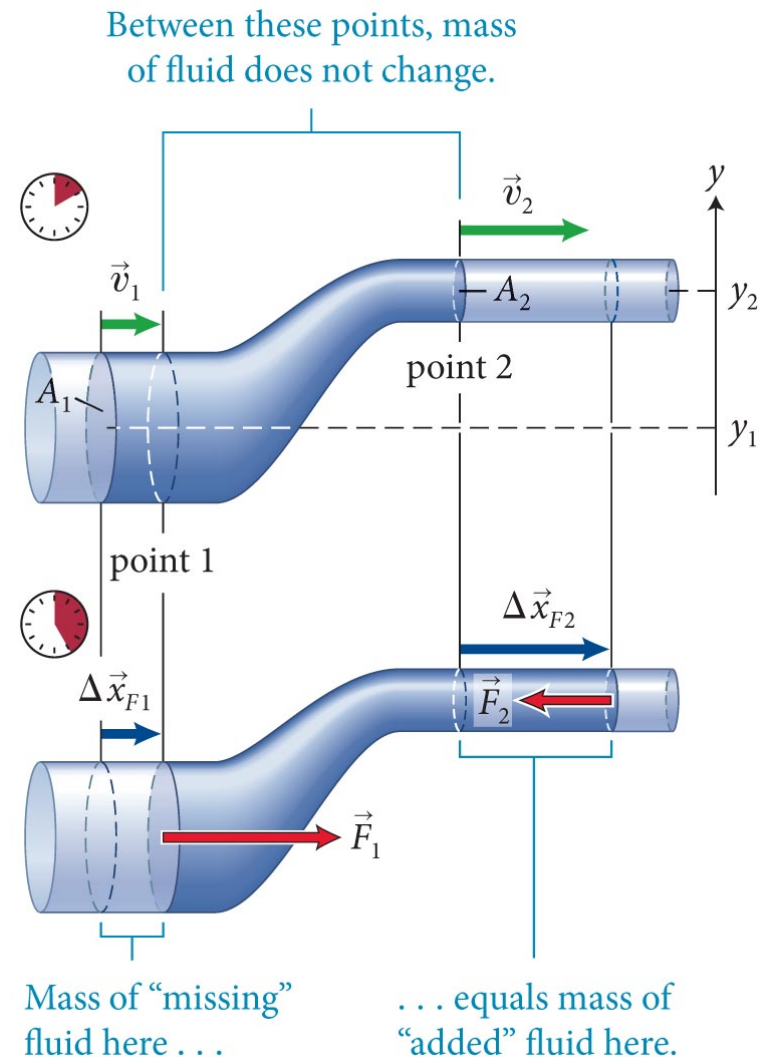

Section 18.7: Bernoulli's equation

- The net work done on the fluid by forces \vec{F}_1 and \vec{F}_2 is

$$W = P_1 A_1 v_1 \Delta t - P_2 A_2 v_2 \Delta t$$

- The energy law then gives us

$$P_1 + \rho g y_1 + \frac{1}{2} \rho v_1^2 = P_2 + \rho g y_2$$

$+ \frac{1}{2} \rho v_2^2$ (laminar flow of incompressible, nonviscous fluid)

- Together with the continuity equation, this equation is known as **Bernoulli's equation**.

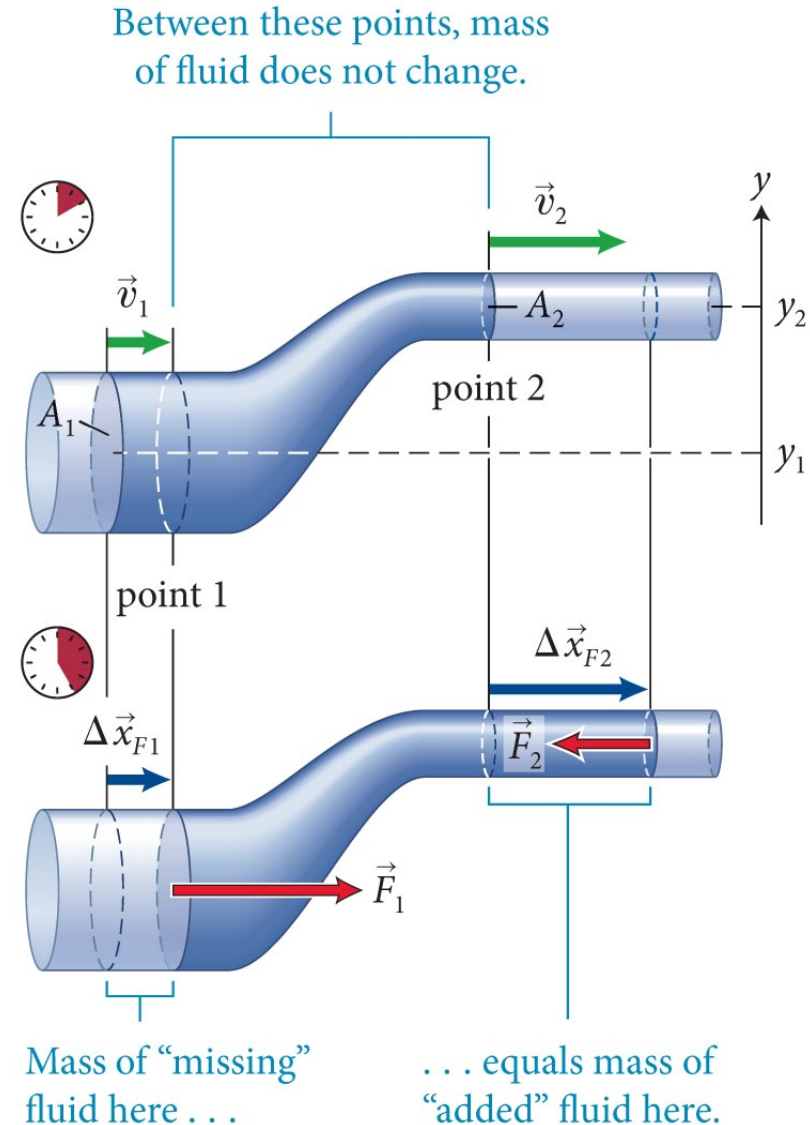

Section 18.7: Bernoulli's equation

Example 18.9 Leaky bucket

Water leaks out of a small hole in the side of a bucket. The hole is a distance d below the surface of the water, and the cross section of the hole is much smaller than the diameter of the bucket. At what speed does the water emerge from the hole?

Section 18.7: Bernoulli's equation

Example 18.9 Leaky bucket (cont.)

1 GETTING STARTED I begin by making a sketch of the bucket (Figure 18.54), defining my point 1 at the water surface and my point 2 at the hole. The bucket can be regarded as a tube open at both ends, with the top opening, cross-sectional area A_1 , as one end and the hole, cross-sectional area A_2 , as the other end.

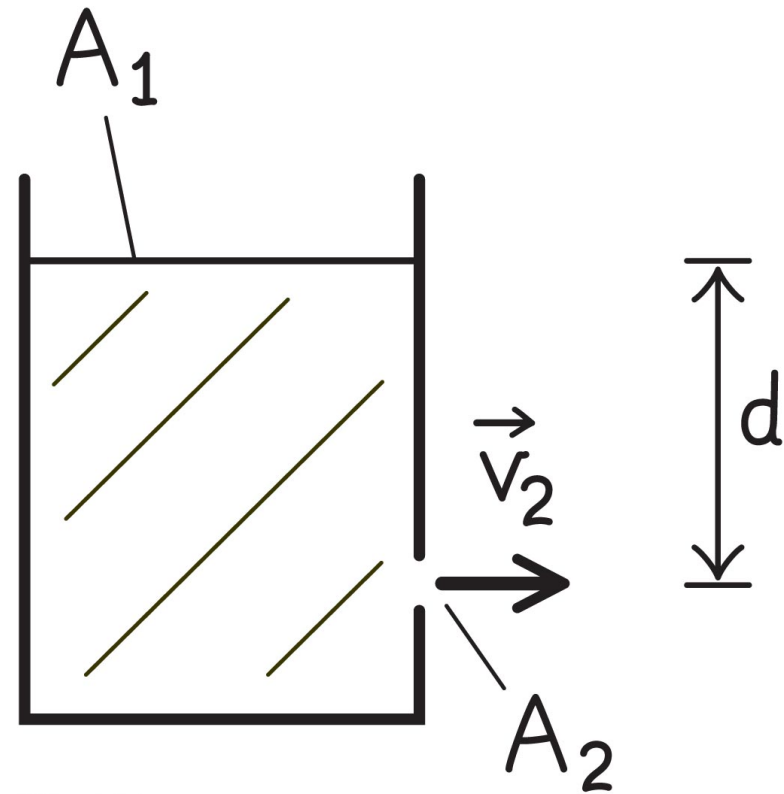

Section 18.7: Bernoulli's equation

Example 18.9 Leaky bucket (cont.)

② DEVISE PLAN Because $A_1 \gg A_2$, the continuity equation ($\rho_1 A_1 v_1 = \rho_2 A_2 v_2$) tells me that the speed v_1 at which the surface of the water moves downward is much smaller than the speed v_2 at which the water emerges from the hole, $v_1 \ll v_2$. For all practical purposes, therefore, I can assume $v_1 \approx 0$.

I also know that the pressure both at the water surface and at the hole is equal to atmospheric pressure. I can then use Bernoulli's equation to determine v_2 .

Section 18.7: Bernoulli's equation

Example 18.9 Leaky bucket (cont.)

③ EXECUTE PLAN Because $P_1 = P_2 = P_{\text{atm}}$, Bernoulli's equation reduces to $\rho g y_1 + \frac{1}{2} \rho v_1^2 = \rho g y_2 + \frac{1}{2} \rho v_2^2$.

Dividing through by $\frac{1}{2} \rho$, setting $v_1 = 0$, and bringing the terms containing y to the left side, I get

$$v_2^2 = 2g(y_1 - y_2) = 2gd, \text{ and so } v_2 = \sqrt{2gd}. \quad \checkmark$$

Which is familiar. Right?

Section 18.7: Bernoulli's equation

Example 18.9 Leaky bucket (cont.)

④ EVALUATE RESULT My answer is equal to the speed acquired over a vertical distance d by a freely falling object starting from rest. Because the Earth-object system is closed, $\Delta K + \Delta U^G = \frac{1}{2}mv^2 - mgd = 0$, and so $v^2 = 2gd$.

My result makes sense: For each water drop that emerges from the hole, the water at the surface is reduced by an equal amount and the kinetic energy of the emerging drop must be equal to the decrease in potential energy.

Section 18.7 Bernoulli's equation

- Another figure. Total flow is vA , where A is the area of the opening?
- Not quite – the water exits as a jet with some velocity components toward the center of the stream – it converges. It contracts to $\sim 62\%$ of the hole diameter.
- Depends wildly on the shape of the discharge tube!

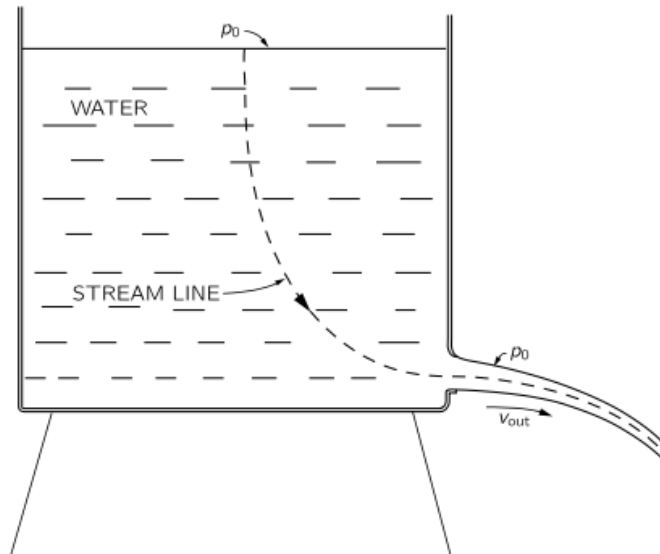

Section 18.7 Bernoulli's equation

- With a re-entrant discharge tube, the stream contracts to *exactly* one-half the area of the opening!
- Has to do with the fact that the fluid is nearly static near the opening ...
- Moving fluids are complicated ...

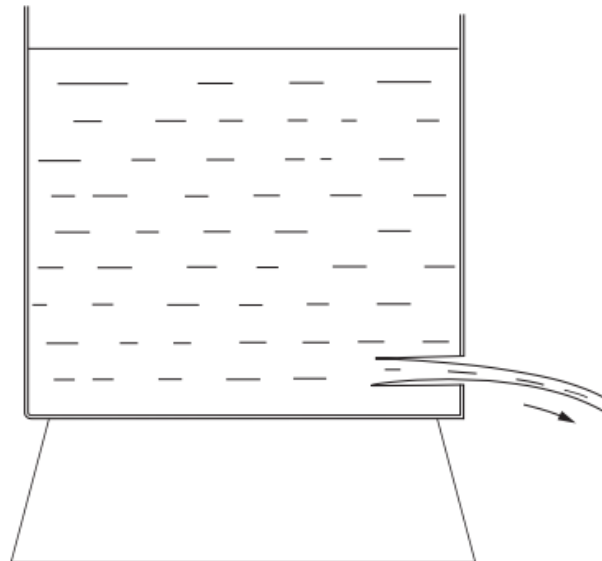

Section 18.7 Bernoulli's equation

- ... and we still haven't considered viscosity!
- What happens in that case?
- Some energy is 'lost' to internal friction, and it is no longer true that $v^2 = 2gd$. Try it!

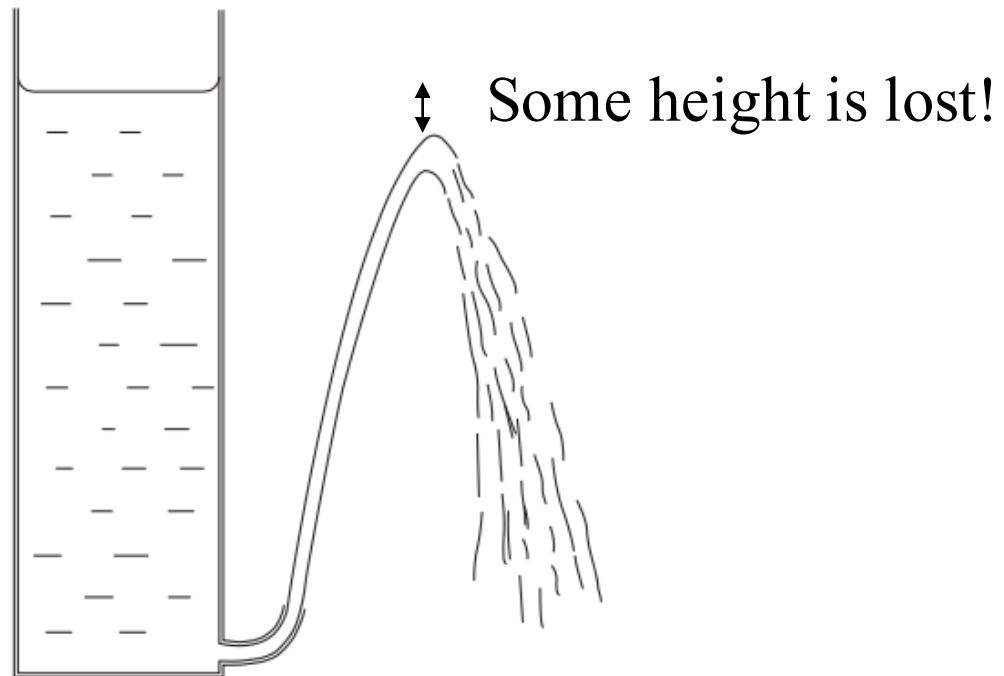

Section 18.7

Question 9

A horizontal aqueduct is constructed of pipes that have different diameters. If the water flow in the aqueduct is laminar, how does the water pressure in a small-diameter section compare with the water pressure in a large-diameter section?

1. It is the same at all points.
2. It is larger in the large-diameter section.
3. It is smaller in the large-diameter section.

Section 18.7

Question 9

A horizontal aqueduct is constructed of pipes that have different diameters. If the water flow in the aqueduct is laminar, how does the water pressure in a small-diameter section compare with the water pressure in a large-diameter section?

1. It is the same at all points.
- ✓ 2. It is larger in the large-diameter section.
3. It is smaller in the large-diameter section.

Continuity: larger diameter means smaller v

Bernoulli: at same y , larger v means smaller P

Section 18.8: Viscosity and surface tension

Section Goals

You will learn to

- Define the concept of **viscosity** for fluids in motion and model viscous forces mathematically.
- Model the surface tension of a liquid surface mathematically.

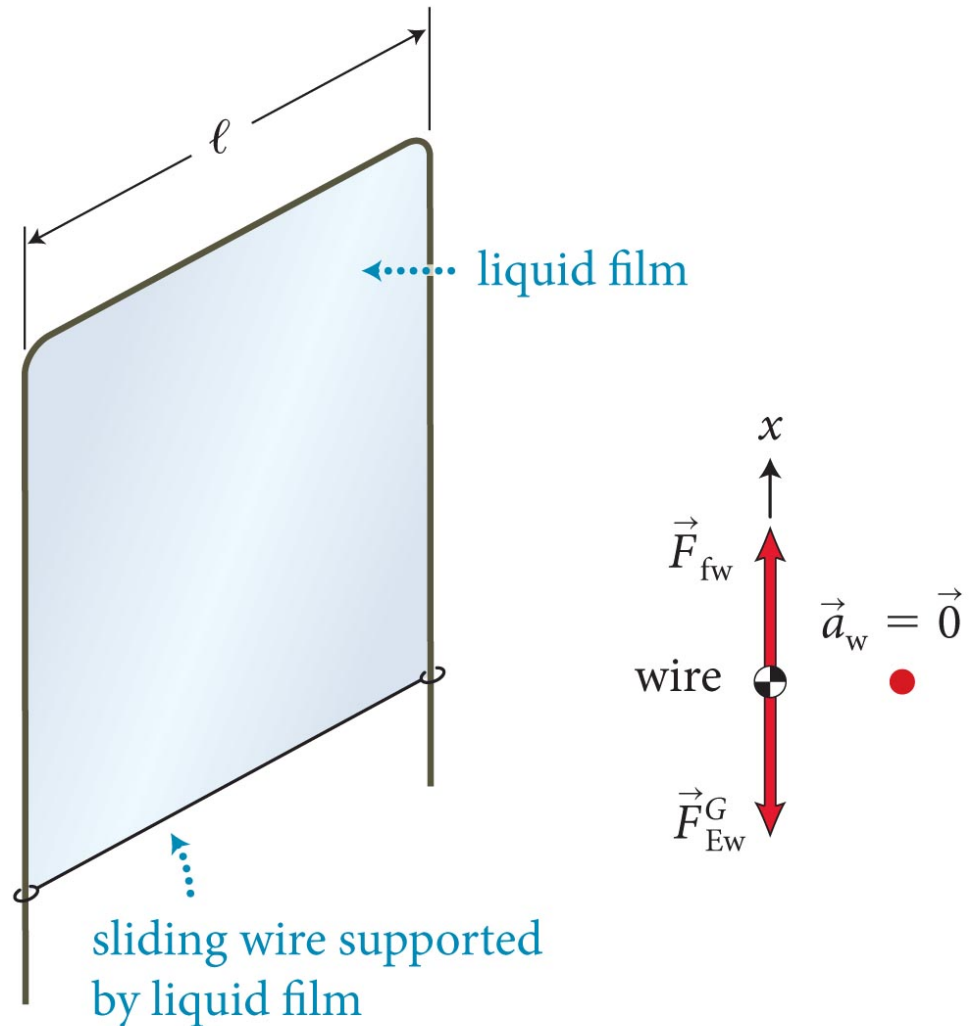

Section 18.8: Viscosity and surface tension

- Viscosity is a measure of a fluid's resistance to **shear stress**.
- In the figure, two flat plates are separated by a viscous fluid, with the lower plate stationary and the upper plate moving at a constant speed.
- Due to the friction between the adjacent fluid layers, a force \vec{F}_{fp} is exerted on the upper plate by the fluid.

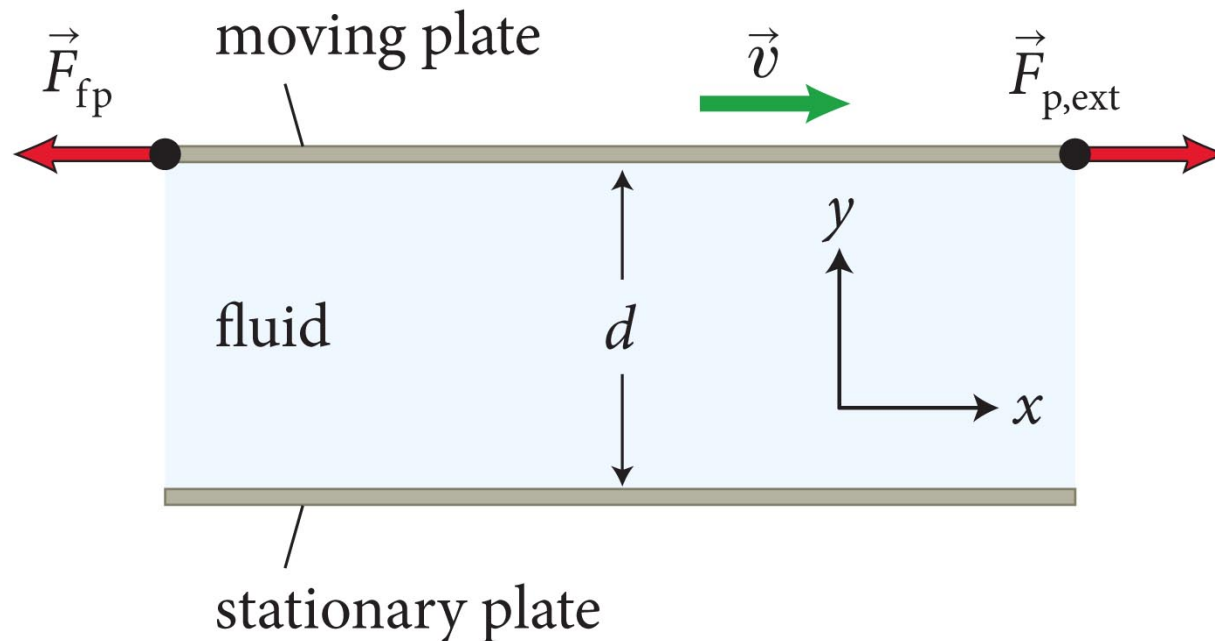

Section 18.8: Viscosity and surface tension

- The x component of force on the upper plate depends on the *velocity gradient* dv_x/dy ,

$$F_{\text{fp } x} = -\eta A \frac{dv_x}{dy}$$

η is the **viscosity** of the fluid, and A is the surface area.

- Depends on *relative* velocity, existence of fluid-surface **boundary layers**, and fluid “friction”
- The SI units of η are $1 \text{ Pa}\cdot\text{s} = 1 \text{ kg}/(\text{m}\cdot\text{s})$.
- This is all basically empirical

Table 18.1 Viscosity of fluids

Fluid	Viscosity (Pa · s)	Temperature (°C)
Air	1.71×10^{-5}	0
	1.81×10^{-5}	20
	2.18×10^{-5}	100
Blood	3.0×10^{-3}	20
	2.0×10^{-3}	37
Castor oil	5.3	0
	0.986	20
	0.017	100
Water	1.79×10^{-3}	0
	1.00×10^{-3}	20
	0.282×10^{-3}	100

“Blood is ‘thicker’ than water” is literally true.

Section 18.8: Viscosity and surface tension

- Consider a fluid flowing through a tube of radius R as illustrated.
- Because viscosity depends on *area* and the energetics depend on *volume*, viscosity dominates for small sizes
- We can show that the volume flow rate of a fluid with nonzero viscosity is

$$Q = \frac{\pi R^4}{8\eta\ell} (p_1 - p_2)$$

(laminar flow in cylindrical tube)

- This is **Poiseuille's law**. R^4 is bad.

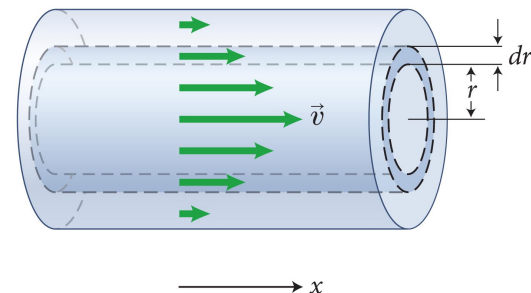
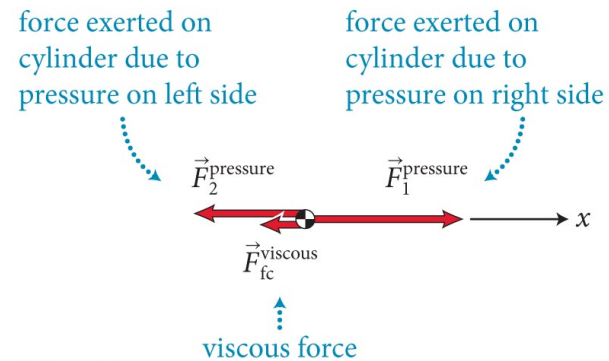
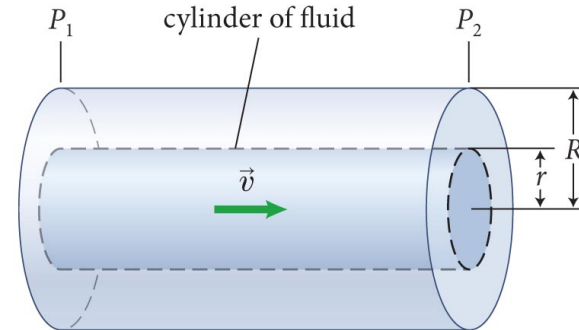

For later: an interesting article

- E.M. Purcell, “Life at Low Reynolds Number”
 - http://www.biotec.tu-dresden.de/fileadmin/groups/guck/Seminar/1977_Purcell_life_at_low_reynolds_number.pdf
- Written by a brilliant, Nobel-winning physicist, it is all about how stuff like bacteria experience life very differently due to the scaling of viscous vs inertial forces with size.
- If you want to understand fluids, or are a ME major, it is worth your time.

Section 18.4: Surface effects

Section Goals

You will learn to

- Model the microscopic interactions at the surfaces of liquids using the concept of **cohesive forces**.
- Define **surface tension** and understand its physical causes.
- Differentiate the appearances of liquids that **wet** and **do not wet** solid surfaces.

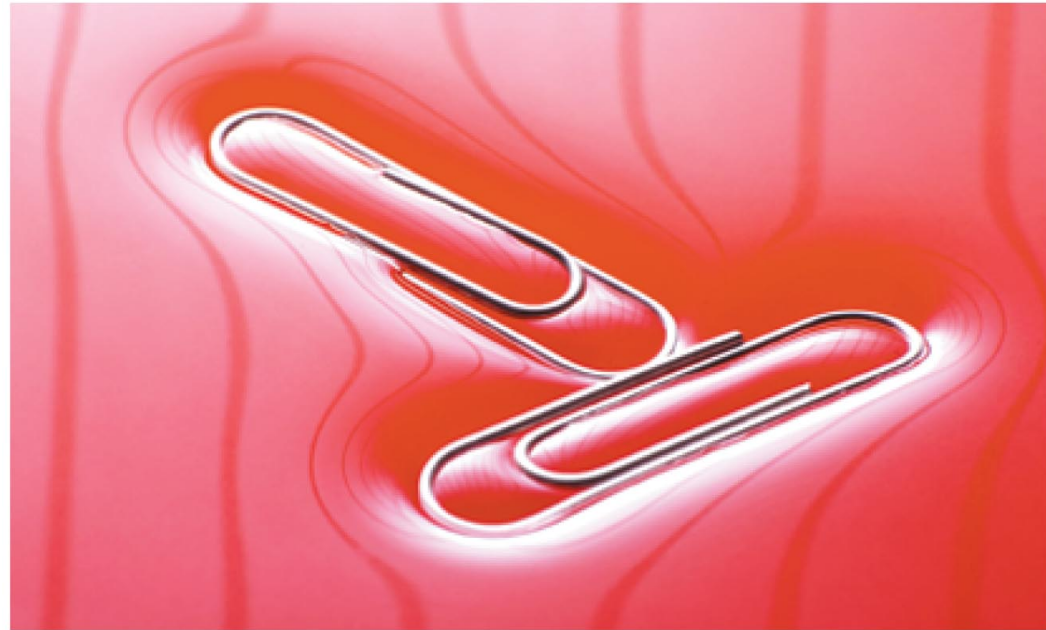

Section 18.4: Surface effects

- Liquids have well-defined surfaces but gasses do not.
- When liquid particles are a few particle diameters apart, they exert attractive forces on each other called *cohesive forces*.
- When the separation distance is less than a particle diameter, the liquid particles strongly repulse each other.

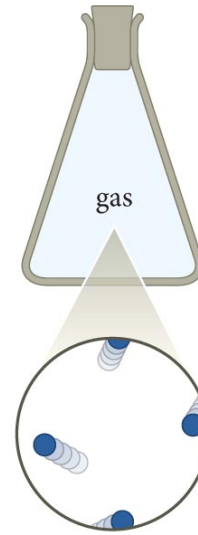

Particles in gas are far apart, so exert no appreciable force on each other:

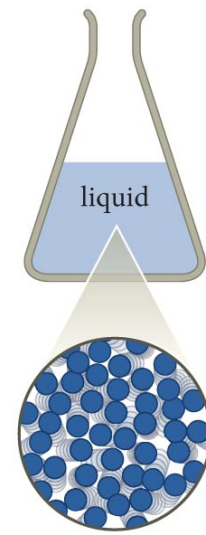
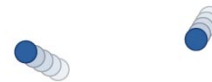

Particles in liquid are close enough to interact. When a few diameters apart, they attract:

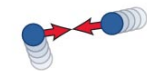

When closer than a diameter apart, they repel strongly:



Section 18.4: Surface effects

- Cohesive forces between liquid particles cause a liquid surface to act like a stretched elastic sheet that tends to minimize the surface area.
- As illustrated in the figure, the surface particles have a nonzero net cohesive force pointing inward toward the liquid.
- Due to the inward pull on all the surface particles, a small volume of liquid tends to arrange itself into a sphere.

(a) Difference between vector sum of cohesive force on molecules at the surface and in the interior of a liquid

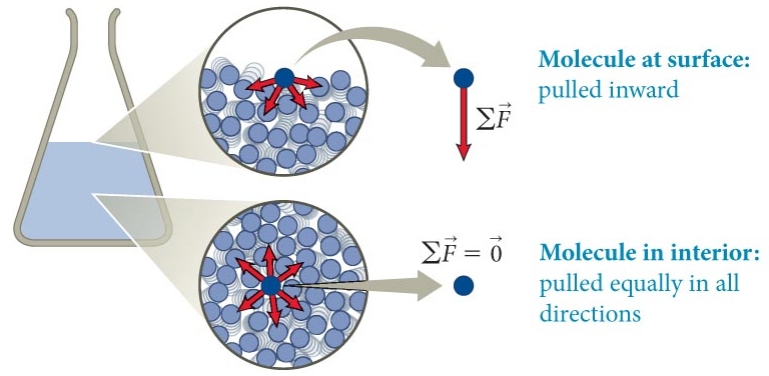

(b) Balloon as analogy for surface forces on liquid droplet

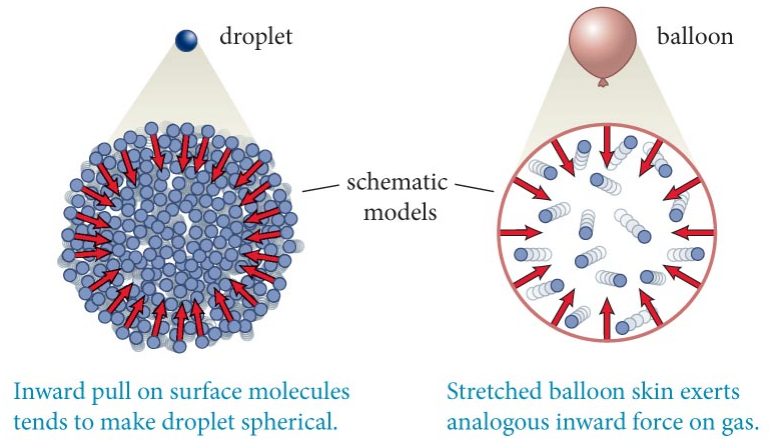

Section 18.4: Surface effects

Exercise 18.4 Scaling a drop

Suppose surface tension increases in direct proportion to surface area (an oversimplification!). How does the ratio of surface tension to the force of gravity exerted on a drop change as the drop diameter increases tenfold?

Section 18.4: Surface effects

Exercise 18.4 Scaling a drop (cont.)

SOLUTION The force of gravity is proportional to the mass of each drop, which is proportional to each drop's volume. The ratio of surface tension to the force of gravity on each drop is therefore proportional to the surface-area-to-volume ratio.

For simplicity, I approximate the smaller drop as a sphere with diameter d . This means that I should compare the surface-area-to-volume ratio of this sphere with the surface-area-to-volume ratio of a sphere of diameter $10d$.

Section 18.4: Surface effects

Exercise 18.4 Scaling a drop (cont.)

SOLUTION The surface area of a sphere of radius $R = \frac{1}{2}d$ is $4\pi R^2 = \pi d^2$, and its volume is $\frac{4}{3}\pi R^3 = \frac{4}{3}\pi(d/2)^3 = \frac{1}{6}\pi d^3$, and so the surface-area-to-volume ratio of a sphere is $(\pi d^2)/(\frac{1}{6}\pi d^3) = 6/d$.

The surface-area-to-volume ratio thus decreases by a factor of 10 as the diameter of the drop increases by a factor of 10. Surface effects are more important for smaller things drops! ✓

Section 18.4: Surface effects

- Let us now consider the analogy between surface tension and the tension in a rubber balloon.
- There is less tension in the uninflated part of the rubber than in the inflated part.

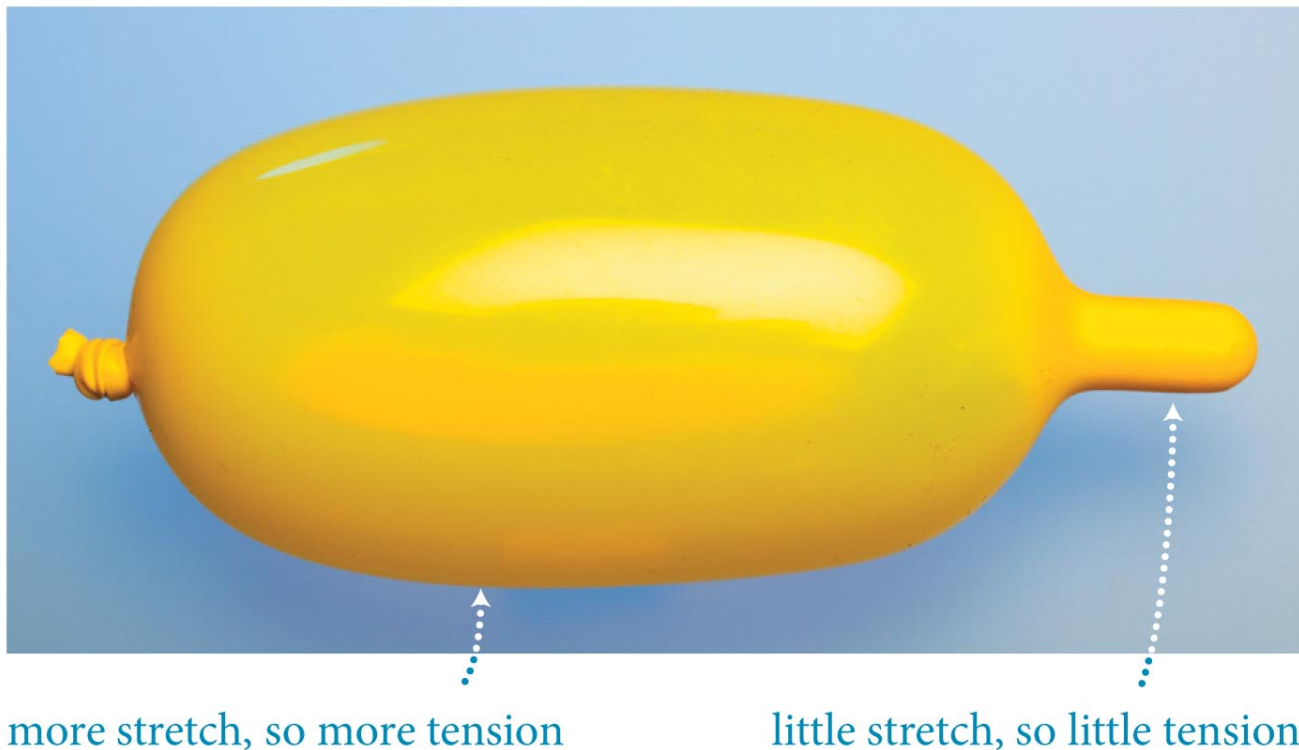

Checkpoint 18.10

 **18.10** How does the air pressure in the uninflated part of the balloon in Figure 18.27 compare with the air pressure in the inflated part?

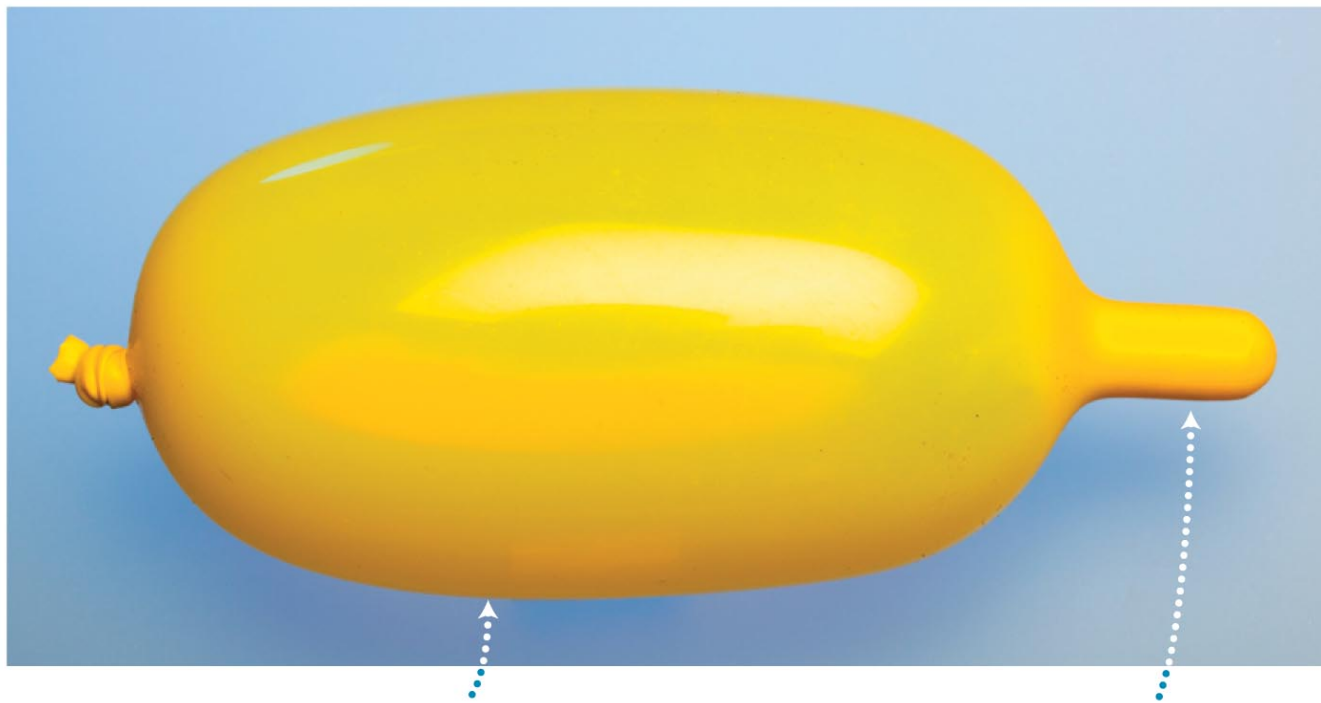

more stretch, so more tension

little stretch, so little tension

Section 18.4: Surface effects

- How can the pressure be the same everywhere in the balloon but the tension be different at different places?
- The reason has to do with the *radius of curvature* as shown.
- In an elastic membrane enclosing a gas, tension in the membrane increases with increasing radius of curvature
- However, the pressure is the same everywhere inside the volume enclosed by the membrane, as required by Pascal's principle.

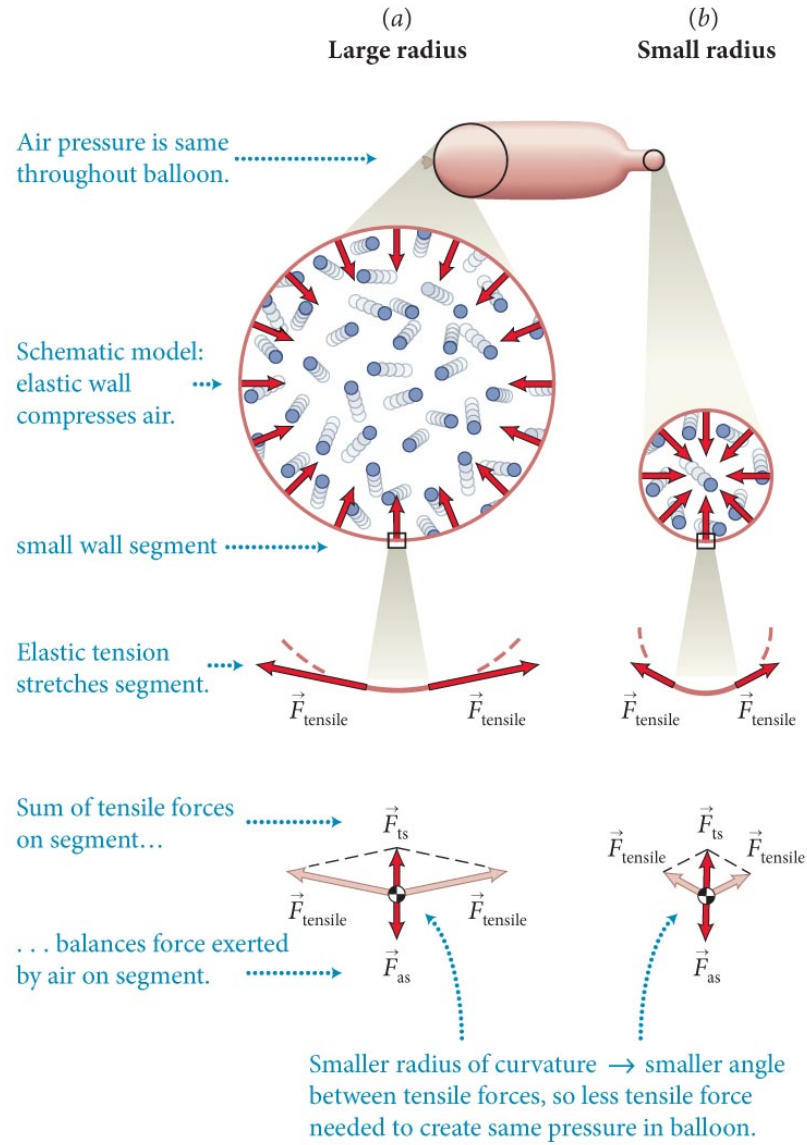

Section 18.4: Surface effects

- As shown in the figure, the constant tensile forces exerted on the surface segments of a liquid droplet causes a greater inward force when the radius of curvature is small.
- This inward force is balanced by an outward force that result from the *pressure difference across surface*.
- As the radius of curvature of a liquid decreases, the pressure difference across the surface increases, with the pressure being greatest on the concave side of the surface.

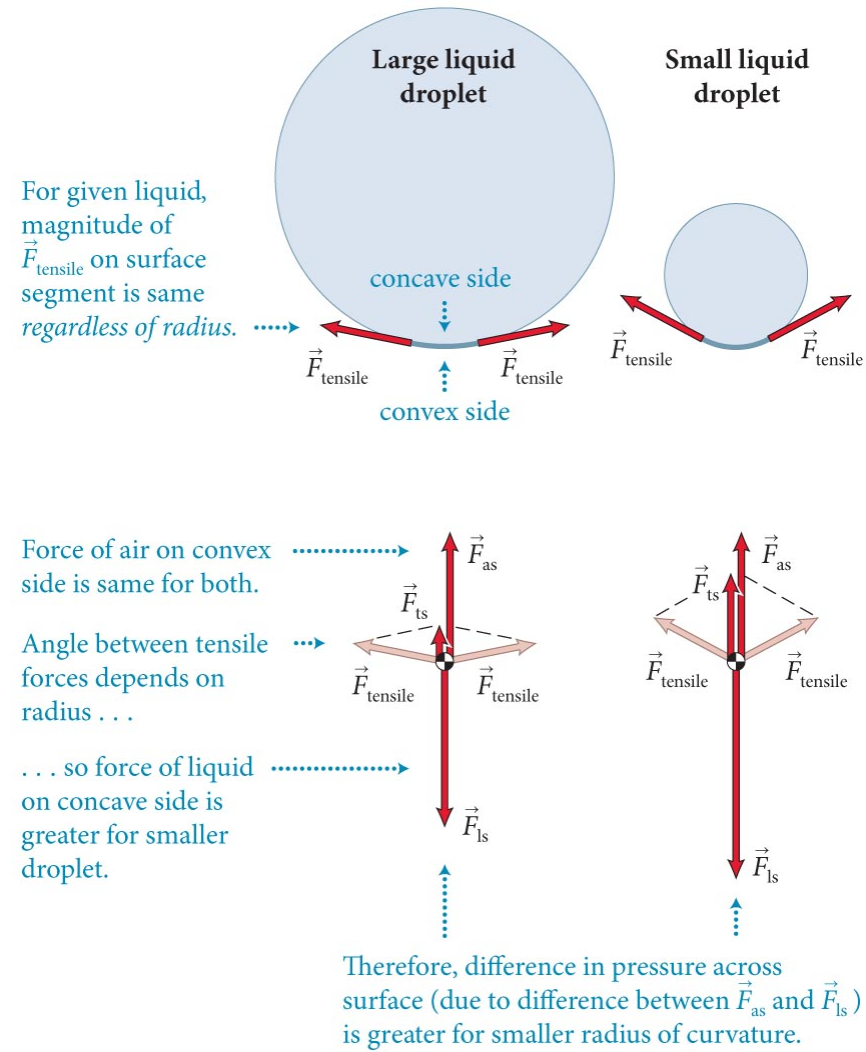

Section 18.4: Surface effects

- Surface tension makes it possible for small insects to walk on a water surface and for a small object to float on a liquid.

(a)

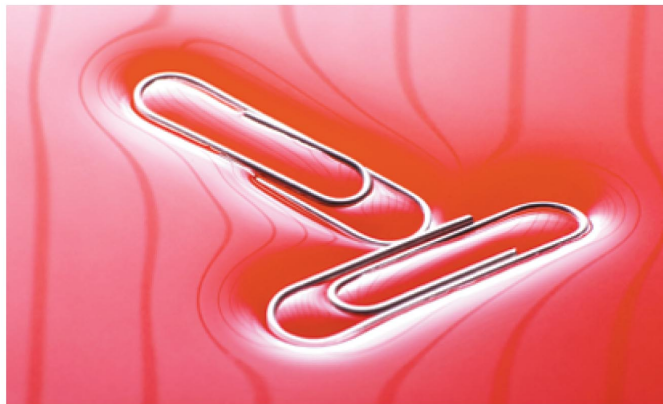

(b)

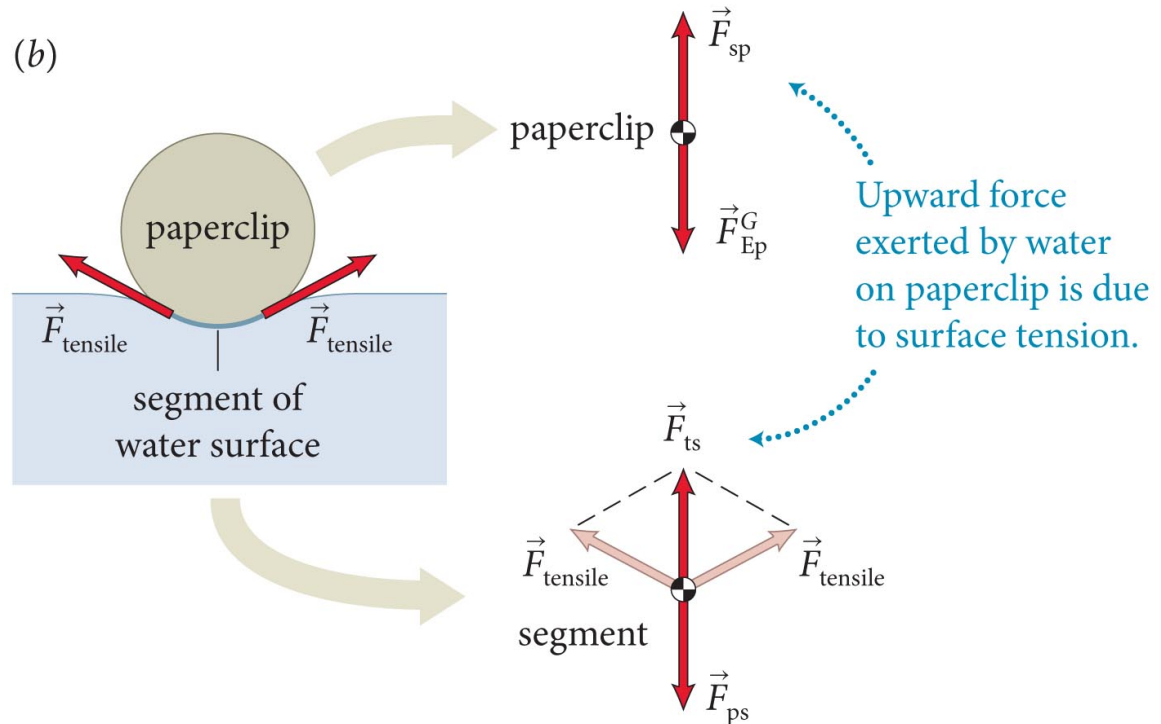

Checkpoint 18.11



18.11 (a) What is the difference between the pressure just below the water surface in a pool and the pressure in the air just above it? (b) Is the pressure inside a raindrop greater than, equal to, or smaller than the pressure in the surrounding air? (c) How does the pressure inside a small raindrop compare with the pressure inside a larger raindrop?

Section 18.4: Surface effects

- A liquid surface that comes into contact with a solid surface forms an angle θ_c with the solid surface.
- This angle, called the *contact angle* is the same for given liquid-solid combination.
- If $\theta_c < 90^\circ$ the liquid is said to wet the solid surface (part *b*).
- If $\theta_c > 90^\circ$ the liquid forms drops instead of spreading out and wetting the solid surface (part *a*).

(a)

Contact angle θ_c is fixed for given combination of liquid and solid.

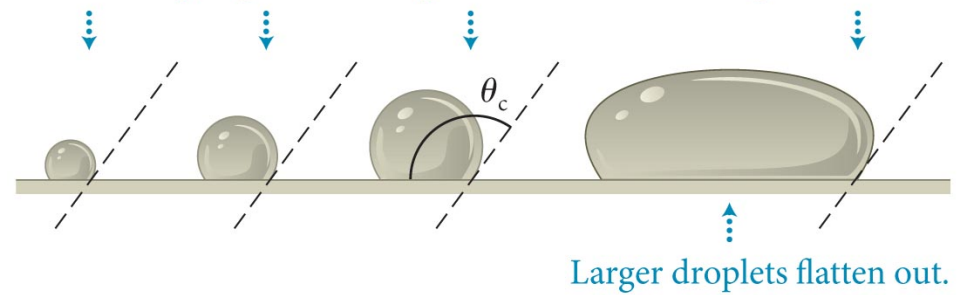

(b)

When contact angle $< 90^\circ$, we say that liquid wets surface.

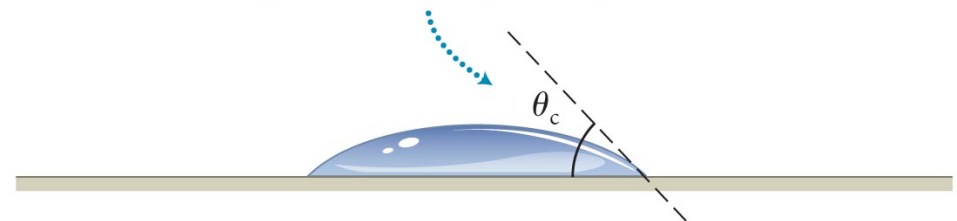

Section 18.4: Surface effects

- The contact angle is due to the interplay between
 1. the *cohesive forces* between the liquid particles, and
 2. the *adhesive forces* between liquid particles and atoms in the solid.
- The figure shows the free-body diagrams for a liquid that wets the solid surface and a liquid that does not.

(a) Liquid wets surface

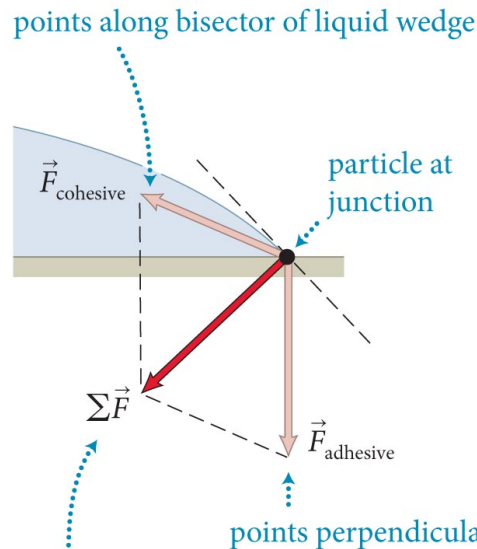

Vector sum must point perpendicular to liquid surface (or particle would move along surface).

(b) Liquid does not wet surface

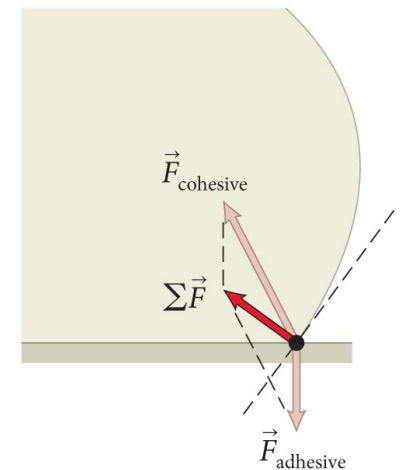

Section 18.4: Surface effects

- In a very narrow tube, called a capillary tube, the surface of a liquid is curved.
- The curved surface is called a **meniscus**.
- The meniscus is concave when the liquid wets the walls of the capillary tube.
- The meniscus is convex when the liquid is nonwetting.

(a) Liquid wets walls

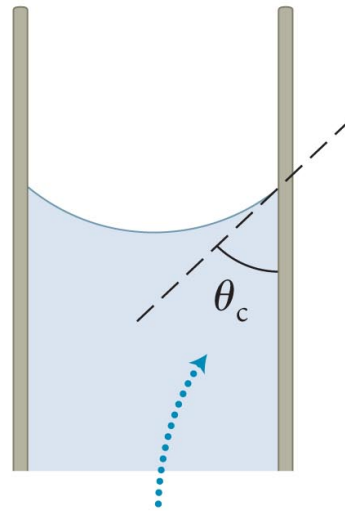

Contact angle $< 90^\circ$,
so meniscus is concave.

(b) Liquid does not wet walls

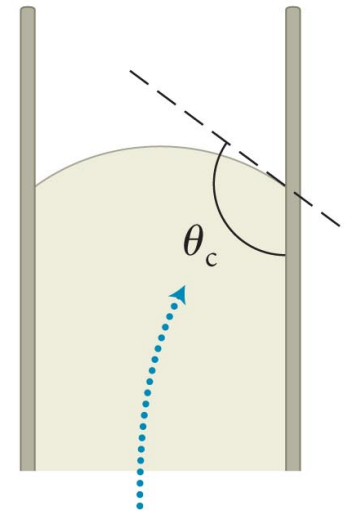

Contact angle $> 90^\circ$,
so meniscus is convex.

Section 18.4: Surface effects

- The free-body diagram illustrates the forces acting on a particle at the gas-liquid-solid junction for a concave meniscus and a convex meniscus.

(a) Liquid wets wall

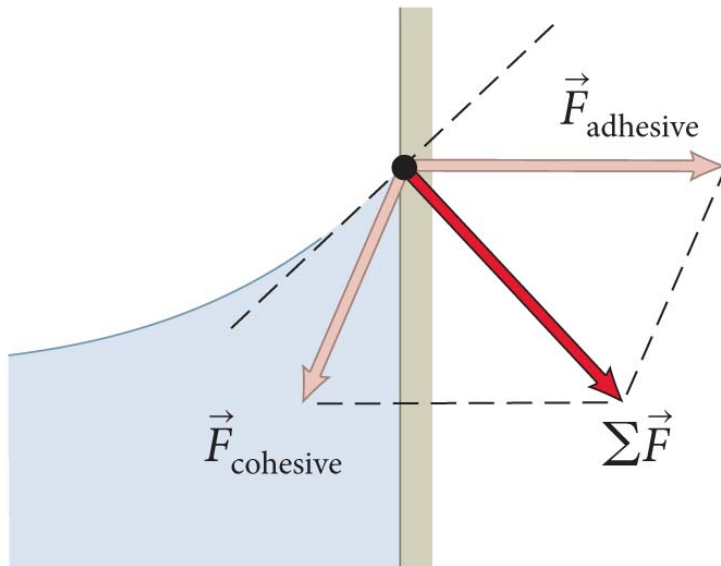

(b) Liquid does not wet wall

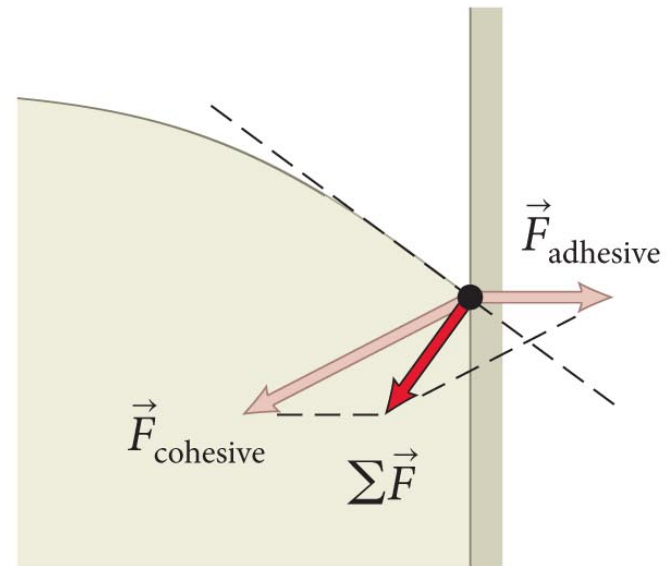

Section 18.4: Surface effects

- The formation of the meniscus is responsible for the rise of liquid in a capillary tube, as shown in the figure.
- This phenomenon is called the *capillary rise*.

Curvature means pressure drops across surface, so $P_p < P_{atm}$.

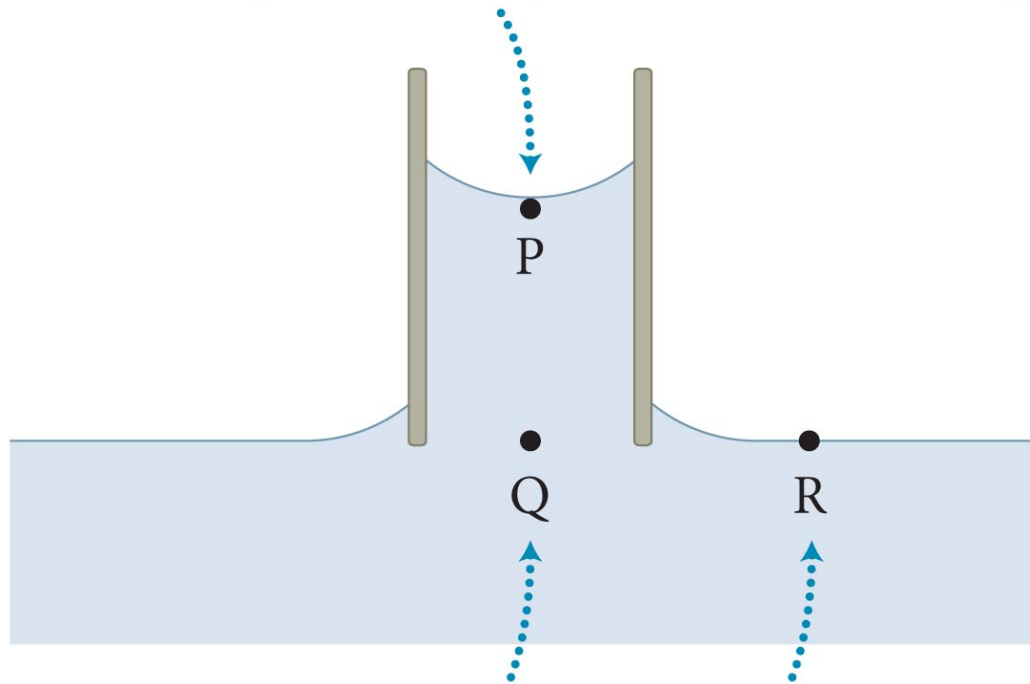

Points Q and R are at same height, so $P_Q = P_R = P_{atm}$.

Section 18.4: Surface effects

- As illustrated in the figure, the narrower the capillary tube, the greater the capillary rise.

